

ROBE

Digital Spot 3000^{DT}

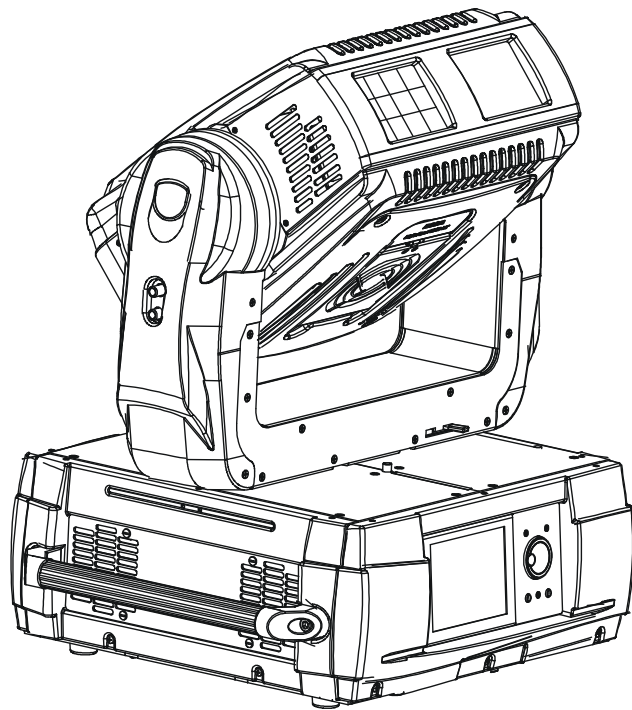

DT series

USER MANUAL

Version 1.5

Table of contents

1. Safety instructions	4
2. Unpacking	5
3. Introduction	6
4. Fixture exterior view	6
4.1 Placing fixture head covers	7
5. Video inputs	7
6. Connection to the mains	8
6.1 Powering on the DigitalSpot 3000 DT	8
6.2 Power down mode	8
7. Shutting down the DigitalSpot 3000 DT	8
8. Positioning the DigitalSpot 3000 DT	8
8.1 Changing the zoom	10
9. Rigging the fixture	10
10. DMX 512 connection	12
11. Ethernet connection	12
12. Folder organization	14
13. Control menu map	15
14. Operating modes	20
15. Control menu	20
15.1 Fixture Address	20
15.2 Fixture information	21
15.3 Personality	21
15.4 Lamp On/Off	23
15.5 Manual control	23
15.6 Stand-alone setting	23
15.7 Preview mode	24
15.8 Reset functions	24
15.9 Service menu	25
15.10 Special functions	25
15.11 Fixture Off	27
16. Keystones	27
17. In Frame and Out Frame parameters	29
18. Video Control	29

19. Playback speed	30
20. Graphic effects.....	31
20.1 Kaleidoscopic effect.....	31
20.2 Circular effect (Fish eye)	33
20.3 RGB (CMY) effects.....	33
21. Media content management.....	38
21.1 Moving files between the fixture and a PC	38
21.2 Moving files between networked fixtures.....	42
22. Remote control of the fixture via WWW browser	42
23. Picture merging.....	46
23.1 Picture merging control channels.....	46
23.2 Picture merging example.....	54
24. Pre-cutted content mode for Picture Merging.....	54
25. Effect video synchronization	56
26. Projection onto angular, cylindric or spheric surfaces	57
26.1 Curved surface support channels	57
26.2 Rectangle onto circle (sphere) mapping with picture merging.....	59
27. Video processing on gobo layers from a streaming video server	60
28. RDM	65
29. Technical specifications	66
30. Error and information messages	69
31. Maintenance.....	70
31.1 Replacing the lamp	70
31.2 Replacing the projector	71
31.3 Replacing the air filters.....	72
31.4 Replacing the fuse	73
31.5 System restore.....	73
31.6 Cleaning	73

**FOR YOUR OWN SAFETY, PLEASE READ THIS USER MANUAL CAREFULLY
BEFORE POWERING OR INSTALLING YOUR DIGITALSPOT 3000 DT !
Save it for future reference.**

This device has left our premises in absolutely perfect condition. In order to maintain this condition and to ensure a safe operation, it is absolutely necessary for the user to follow the safety instructions and warning notes written in this manual.

The manufacturer will not accept liability for any resulting damages caused by the non-observance of this manual or any unauthorized modification to the device.

Please consider that damages caused by manual modifications to the device are not subject to warranty.

The DigitalSpot 3000 DT was designed for indoor use and it is intended for professional application only. It is not for household use.

1. Safety instructions

DANGEROUS VOLTAGE CONSTITUTING A RISK OF ELECTRIC SHOCK IS PRESENT WITHIN THIS UNIT!

Make sure that the available voltage is not higher than stated on the rear panel of the fixture. This fixture should be operated only from the type of power source indicated on the marking label. If you are not sure of the type of power supplied, consult your authorized distributor or local power company.

Always disconnect the fixture from AC power before cleaning, removing or installing the fuses, or any part.

Make sure that the power switch is set to off-position before you connect the fixture to the mains. The power plug has to be accessible after installing the fixture. Do not overload wall outlets and extension cords as this can result in fire or electric shock.

Do not allow anything to rest on the power cord. Do not locate this fixture where the cord may be damaged by persons walking on it.

Make sure that the power cord is never crimped or damaged by sharp edges. Check the fixture and the power cord from time to time.

Refer servicing to qualified service personnel.

This fixture falls under protection class I. Therefore this fixture has to be connected to a mains socket outlet with a protective earthing connection.

Do not look straight at the fixture objective lens or LED module during operation. The intense light beam may damage your eyes.

If the device has been exposed to drastic temperature fluctuation (e.g. after transportation), do not switch it on immediately. The arising condensation water might damage your device. Leave the device switched off until it has reached room temperature.

Do not shake the device. Avoid brute force when installing or operating the device.

DigitalSpot 3000 DT

This fixture was designed for indoor use only, Do not expose this unit to rain or use near water.

When choosing the installation spot, please make sure that the device is not exposed to extreme heat, moisture or dust.

Air vents and slots in the fixture's head and base are provided for ventilation, to ensure reliable operation of the device and to protect it from overheating.

The openings should never be covered with cloth or other materials, and never must be blocked.

This fixture should not be placed in a built-in installation unless proper ventilation is provided.

Always use a secondary safety cable when mounting this fixture.

Only operate the fixture after having checked that the housing is firmly closed and all screws are tightly fastened.

Make sure that the area below the installation place is blocked when rigging, derigging or servicing the fixture.

Do not block the front objective lens with any object when the fixture is under operation.

The lamp becomes extremely hot during operation. Allow the fixture to cool approximately 40 minutes prior to removing the lamp assembly for replacement. Do not operate lamps beyond the rated lamp life.

Operate the fixture only after having familiarized with its functions. Do not permit operation by persons not qualified for operating the fixture. Most damages are the result of unprofessional operation!

Please use the original packaging if the fixture is to be transported.

Please consider that unauthorized modifications on the fixture are forbidden due to safety reasons!

If this device will be operated in any way different to the one described in this manual, the product may suffer damages and the guarantee becomes void. Furthermore, any other operation may lead to dangers like short-circuit, burns, electric shock, lamp explosion, crash etc.

To switch the DigitalSpot 3000 DT off, always use either option "Fixture Off" in main menu or set a DMX value of channel 8 between 240-249.

Never switch the fixture off by pulling out the power plug from the socket otherwise the fixture may be damaged (projector lamp, operating system...)!

2. Unpacking

The DigitalSpot 3000 DT is packaged in either a cardboard box or one-unit (two-unit) flight case to protect the product during shipment.

The following items are included:

- the DigitalSpot 3000 DT
- 2 omega holders
- the USB 2.0 flash drive with a System recovery utility
- this user manual

3. Introduction

The DigitalSpot 3000 DT features moving head with a video projection and automated lighting technologies including a DMX controllable digital media server installed in a fixture's base. The built-in 32-bit Graphics Engine utilizes Linux and DirectX application programming interface to provide extensive image control of graphic objects. The Digital spot 3000 DT uses DMX512 protocol to control hardware functions like pan, tilt, and focus, as well as media fixture capabilities including loading images and movies. The graphics engine allows you manipulate position, scale, rotation, apply visual effects and colour mix each image.

S-Video and VGA inputs for direct input to data projectors are handy for performing presentations.

S-Video and Composite live inputs can be used in graphics effects of DigitalSpot 3000 DT

4. Fixture exterior view

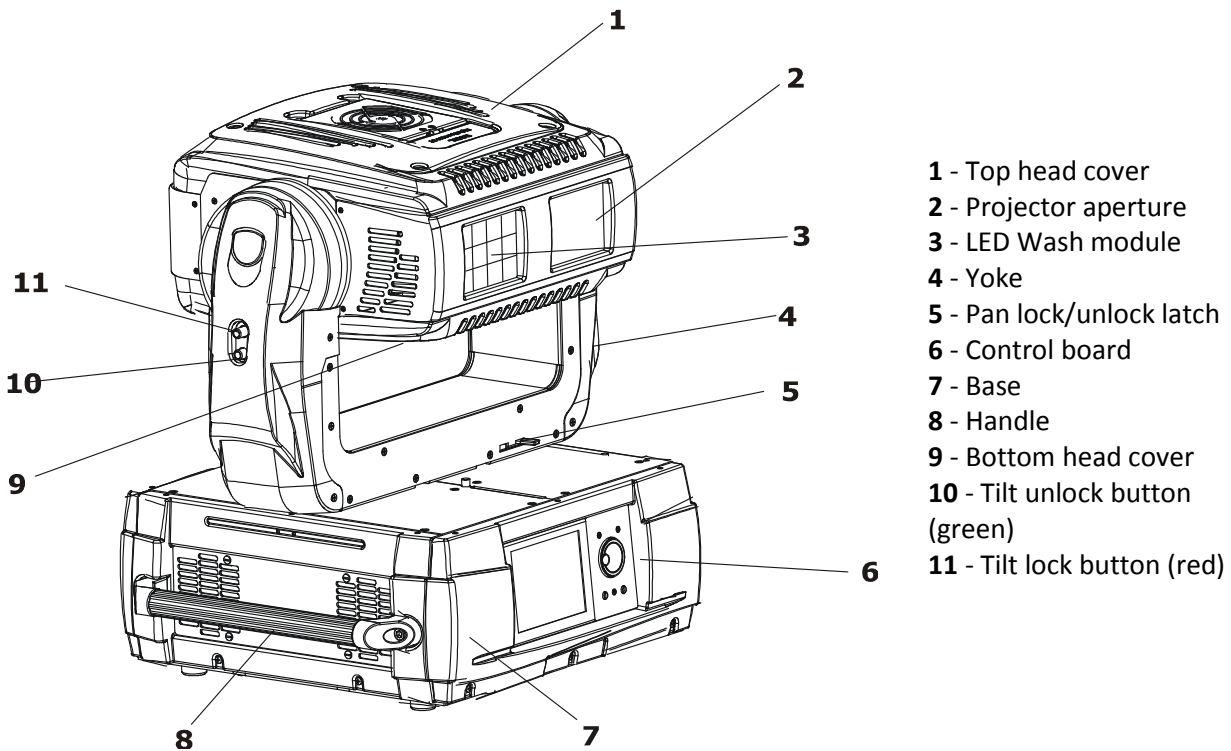

Front panel of fixture base

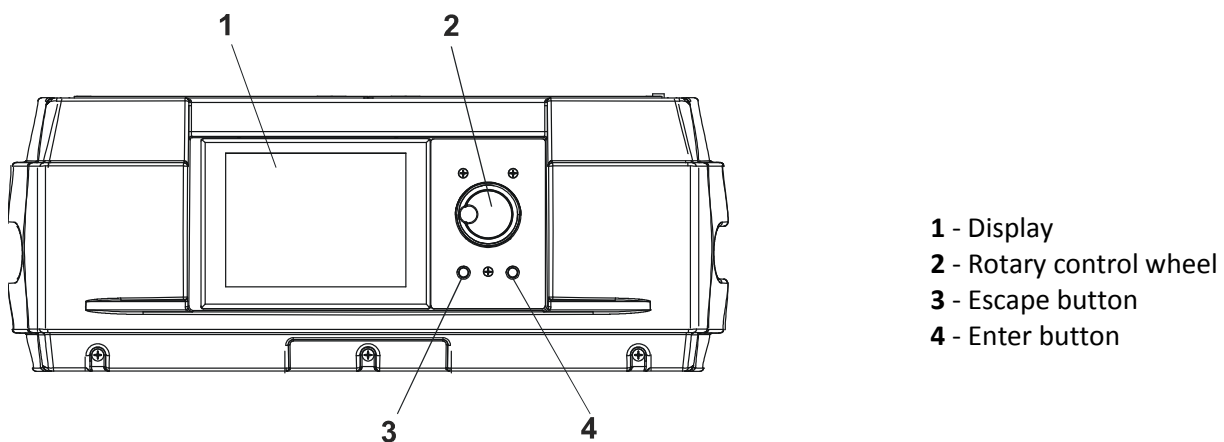

Rear panel of the fixture base

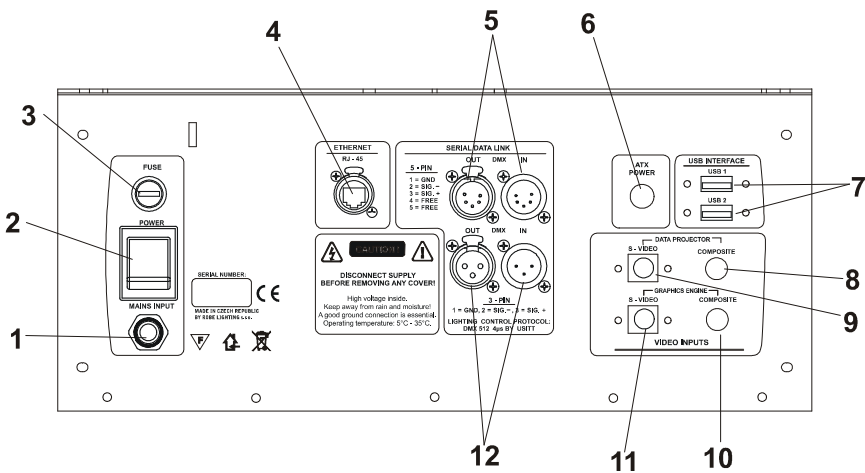

- 1 - Power cord
- 2 - Power switch
- 3 - Fuse
- 4 - LAN (RJ-45) port
- 5 - DMX input/output (5-pin XLR)
- 6 - ATX switch
- 7 - 2 x USB port
- 8 - Composite input-dataprojector
- 9 - S-video input-dataprojector
- 10 - Composite input-dataprojector
- 11 - S-video input- graphics engine
- 12 - DMX input/output (3-pin XLR)

4.1 Placing fixture head covers

The head cooling fans are fixed in head covers and their supply is realized by a pair of springy contacts.

The head covers cannot be interchanged otherwise the fans will not work.

Pay attention to correct placing the covers on the fixture head.

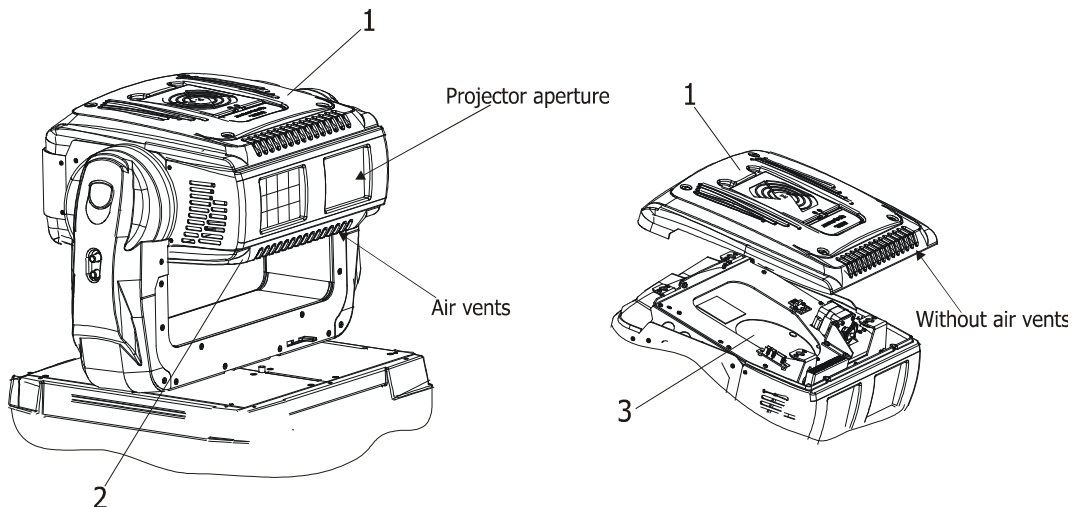

The top head cover (1) does not have air vents at its front and shelters the top projector side with the lamp cover (3).

The bottom head cover (2) has air vents at its front and shelters bottom projector side.

5. Video inputs

Both **Composite** (8) and **S-Video** (9) inputs provide direct connection to the projector. The inputs are intended for a static presentation as data going through the inputs cannot be processed in a graphics engine ,it means that graphics effects from a DMX protocol will not be usable. In this use of the fixture, the function of Keystoning from a DMX protocol will not operate. Next both inputs **Composite** (10) and **S-Video** (11) enable to process data in a graphics engine, it is means that you can use all spectrum of effects that the DMX protocol offers

6. Connection to the mains

Install a suitable plug on the power cord, note that the cores in the power cord are colored according to the following table.

Core (Eu)	Core (US)	Pin	Symbol
Brown	Black	Live	L
Light blue	White	Neutral	N
Yellow/Green	Green	Earth	

The earth has to be connected!

6.1 Powering on the DigitalSpot 3000 DT

When the fixture is connected to the AC mains supply and the power switch is on, it automatically begins a homing procedure to verify that all functions of the fixture and its internal projector are in good order.

6.2 Power down mode

This mode omits fixture reset after switching the fixture on and deactivates all motors. The "Power down mode" is useful in special events e. g. if the fixture is placed in a flight case and you want to set its DMX address without taking it out from the case. To enter the "Power down mode", press and hold the [ENTER] button and at the same time switch on the Power switch. Press the [ESC] button to see a notice "Power Down Mode."

Now you can use the fixture menu to set desired behaviour of the unit. If you want to go to the standard operation mode without switching the fixture off, run total reset of the fixture (menu item **Reset all Systems**).

7. Shutting down the DigitalSpot 3000 DT

There are two recommended ways how to shutdown the fixture:

1. A DMX controller can switch off the projector lamp and shut down the fixture with the "Lamp Off, Fixture Off" option on the control channel 8 (see DMX protocol).
2. The option "Fixture Off" in main menu of DigitalSpot 3000 DT switches off the projector's lamp and shuts down the fixture.

After shutting down the fixture switch the power switch on the rear side of the fixture base to the off position in order to save energy.

***Removing power directly without the shutdown procedure
can reduce fixture reliability!***

8. Positioning the DigitalSpot 3000 DT

The DigitalSpot 3000 DT is designed to be installed in one of four possible installation locations:

1. Front Table - the fixture is placed near the floor in front of the screen.
2. Front Ceiling - the fixture is suspended upside-down from the ceiling (truss) in front of the screen.
Set Ceiling Projection in the menu Personality ("Personality--->"Projection Presetting"
--->"Ceiling Projection"--->"On")
3. Rear Table - the fixture is placed near the floor behind the screen. Set Rear Projection in the menu Personality ("Personality--->"Projection Presetting"--->"Rear Projection"--->"On")
Note that a special rear projection screen is required.
4. Rear Ceiling - the fixture is suspended upside-down from the ceiling (truss) behind the screen.
Set Rear Projection in the menu Personality ("Personality--->"Projection Presetting"--->"Rear Projection"--->"On") and Ceiling Projection ("Personality--->"Projection Presetting"
--->"Ceiling Projection"--->"On")

DigitalSpot 3000 DT

Note that a special rear projection screen is required.

When determining the position of the fixture and projection screen, you will need to account for the projected image size, which is directly proportional to the projection distance.

There is a chart of throw distance ratio of 1.8-2.0: 1 to assist you in determining the ideal location for your fixture.

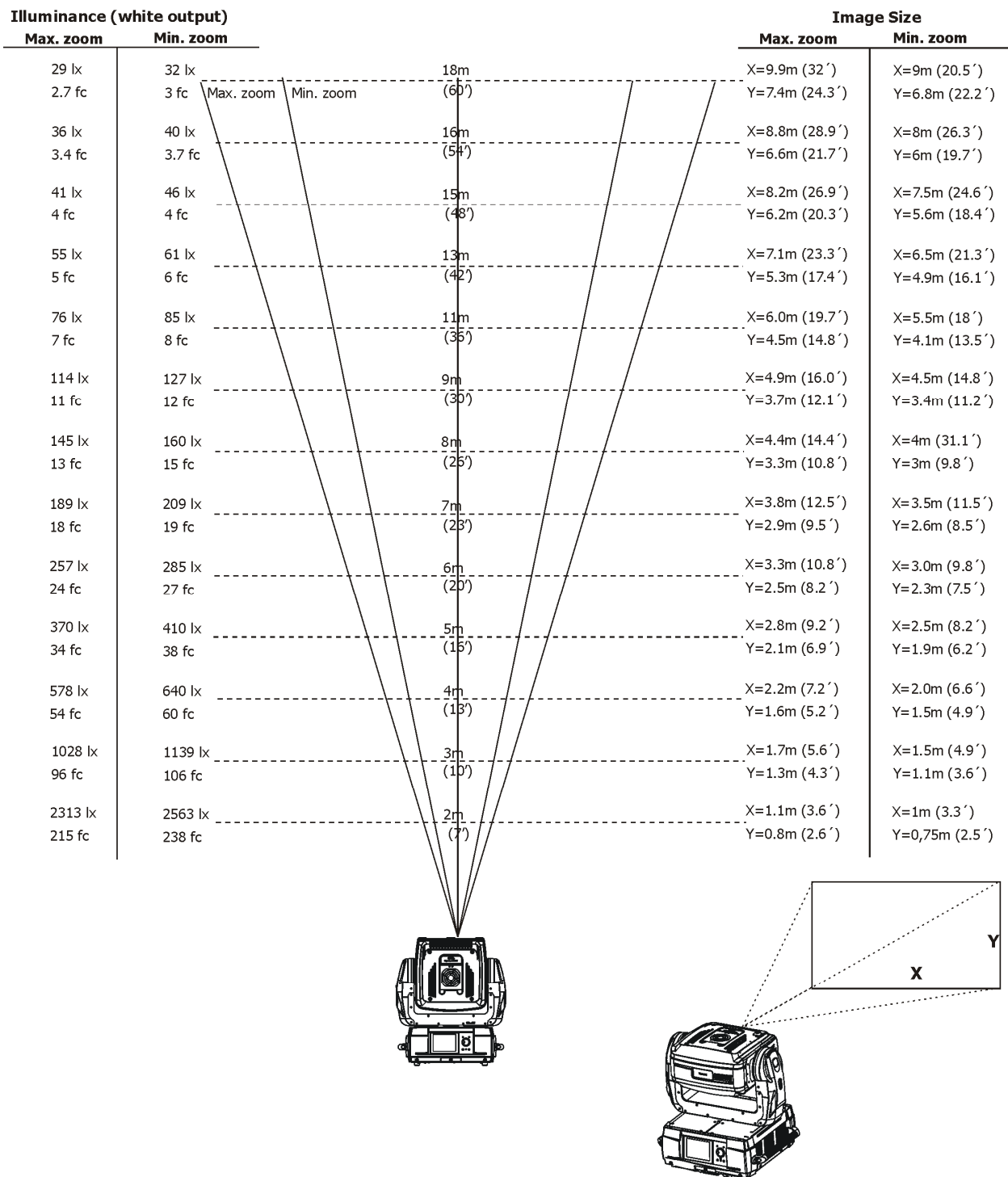

Min zoom is default setting. Max. zoom is possible after manual adjustment only. See instructions below.

Note: There is a tolerance among these numbers due to optical component variations. We recommend that if you intend to permanently install the DigitalSpot 3000 DT, you should physically test the projection size and distance using the actual fixture in m before you permanently install it, so as to make allowance for this projector's optical characteristics. This will help you determine the exact mounting position so that it best suits your installation location

8.1 Changing the zoom

1. Turn the power off and if the projector lamp was on, wait 10 minutes until the projector has cooled.
2. Remove the top cover of the fixture head by loosening the four quarter-turn fasteners (1).
3. Unscrew 2 fastening screws (2) which secured the focus driving motor (3). Turn the motor up in order to allow an access to the zoom ring (4).
4. Turn the zoom ring to the right position to set max. zoom. (Right position-min. zoom-default setting).
5. Tilt the focus driving motor back to the chassis and secure it by 2 crews.
6. Fasten the top cover back on the fixture head.

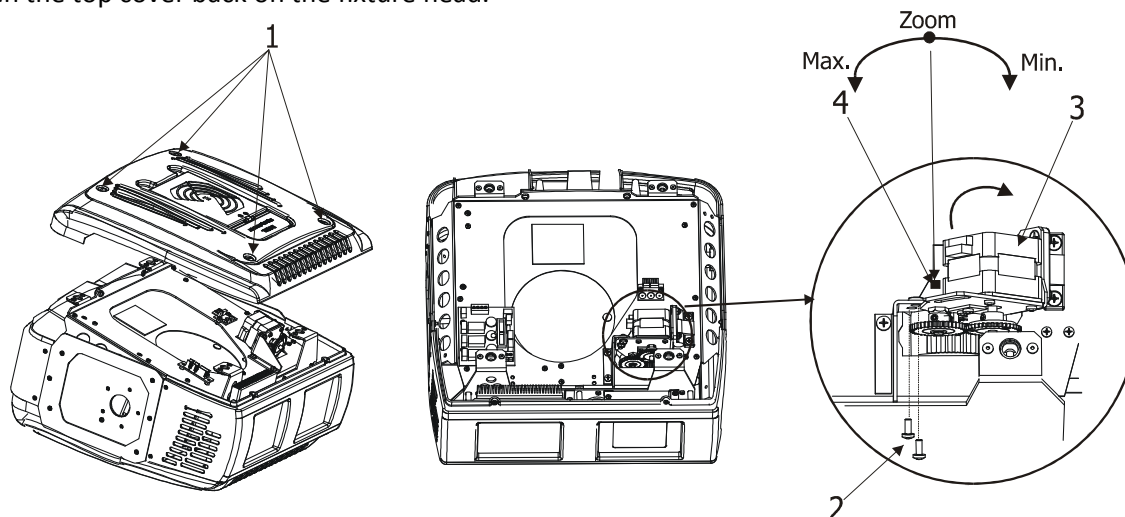

9. Rigging the fixture

Please consider the respective national norms during the installation!

Verify the truss or support will handle the combined weight of all the fixtures on the truss

Always use a secondary safety cable when mounting this fixture

When rigging, derigging or servicing the fixture staying in the area below the installation place, on bridges, under high working places and other endangered areas is forbidden.

The operator has to make sure that safety-relating and machine-technical installations are approved by an expert before taking into operation for the first time and after changes before taking into operation another time.

The operator has to make sure that safety-relating and machine-technical installations are approved by a skilled person once a year.

To ensure reliable operation of the product and to protect it from overheating, the vents must not be blocked or covered.

Hot air is exhausted from the exhaust vent. Do not put any flammable object near the fixture, hot air is exhausted from the air vents.

Keep the exhaust vents at least 1 m away from any objects.

Do not touch peripheral parts of the exhaust vent, especially screws, grids and metallic parts. These areas will become hot while the fixture is being used.

Do not put anything on the fixture. Objects put on the fixture will not only get damaged but also may cause fire hazard by heat.

Allow the fixture to cool for 20 minutes before handling.

The fixture should be installed out of the reach of people.

IMPORTANT! Overhead rigging requires extensive experience, including calculation of working load limits, installation material being used, and periodic safety inspection of all installation material and the fixture. If you lack these qualifications, do not attempt the installation yourself, but instead use a professional structural rigger. Improper installation can result in bodily injury and or damage to property.

The fixture must never be fixed swinging freely in the room.

Use 2 appropriate clamps to rig the fixture on a truss.

**Make sure that the device is fixed properly!
Ensure that the structure (truss) to which you are attaching
the fixtures is secure.**

A pair of the Omega holders can be placed in 2 positions on the bottom of the base. Use 2 clamps (not supplied) with screws M12.

For overhead use, always install a safety cable that can hold at least 10 times the weight of the fixture. You must only use safety cables with screw-on carbiners. Pull the safety cable through the two apertures on the bottom of the base and over the trussing system etc. Insert the end in the carbine and tighten the fixation screw.

To install the fixture on the truss:

1. Bolt clamp (1) to the omega holder (2) with M12 bolt and lock nut through the hole in the holder.
2. Fasten the omega holders on the bottom of the base by inserting both quick-lock fasteners (3) into the holes of the base and tighten fully clockwise.
3. Fasten the safety-rope (4) through the two apertures in the bottom of the base and over the trussing system.

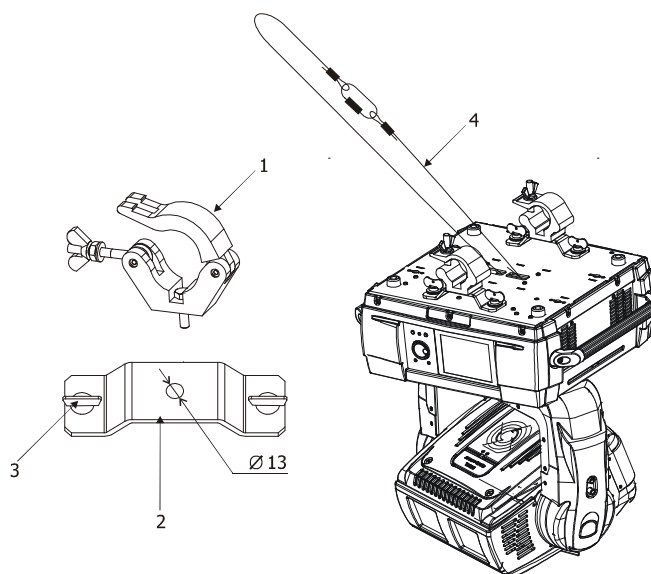

**Before taking into operation for the first time,
the installation has to be approved by an expert!**

We recommend avoiding dusty/smoky environments when operating the fixture. Usage in these environments may cause a poor image quality. When using the projector under dusty or smoky conditions, dust may accumulate on a lens or optical elements inside the projector. Such condition may degrade the quality of the projected image.

10. DMX 512 connection

The fixture is equipped with both 3-pin and 5-pin XLR sockets for DMX input and output. Only use a shielded twisted-pair cable designed for RS-485 and 3-pin/5-pin XLR- connectors in order to connect the controller with the fixture or one fixture with another.

Wiring of the XLR connectors:

DMX output
XLR mounting sockets (rear view):

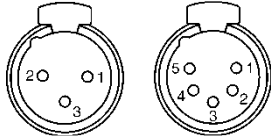

1 – Shield

2 - Signal (-)

3 - Signal (+)

4 – Not connected

5 – Not connected

DMX input
XLR mounting plugs (rear view):

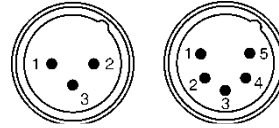

To build a DMX chain

1. Connect the DMX output of the first fixture in the DMX chain with the DMX input of the next fixture. Always connect one output with the input of the next fixture until all fixtures are connected.
2. Use menu "DMX Settings " to set the DMX start address on all fixtures (see the "Fixture address" menu).
3. The option Activate DMX mode has to be confirmed in the "DMX Settings" menu on all fixtures.
Do not overload the link. Max. 32 fixtures may be connected on a DMX link.

Example:

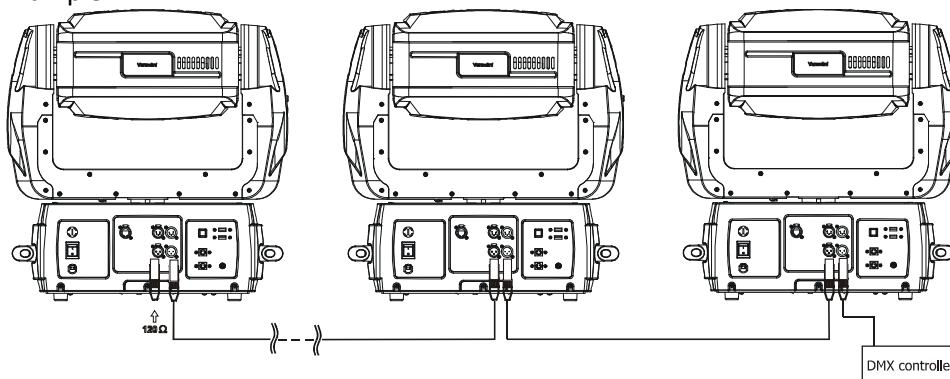

Caution: Terminate the link by installing a termination plug in the DMX output of the last fixture. The termination plug is a male 3-pin XLR plug with a 120 Ohm resistor soldered between Signal (-) and Signal (+).

11. Ethernet connection

The fixtures on a data link are connected to the Ethernet network with an Art-Net communication protocol. The controlling software from PC (or lighting console) has to support the Art-Net protocol.

The Art-Net communication protocol is a 10 Base T Ethernet protocol based on the TCP/IP. Its purpose is to allow transfer of large amounts of DMX 512 data over a wide area using standard network technology.

IP address is the Internet protocol address. The IP uniquely identifies any node (fixture) on a network.

The Universe is a single DMX 512 frame of 512 channels.

The DigitalSpot 3000 DT is equipped with 8-pin RJ-45 socket for Ethernet input. Use a network cable category 5 (with four "twisted" wire pairs) and standard RJ-45 plugs in order to connect the fixture to the network.

RJ-45 socket (front view):

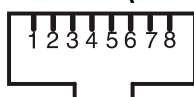

1- TD+

5- Not connected

RJ-45 plug (front view):

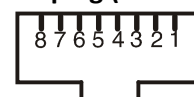

DigitalSpot 3000 DT

2- TD-	6- RX-
3- RX+	7- Not connected
4- Not connected	8- Not connected

Patch cables that connect fixtures to the hubs or LAN sockets are wired 1:1, that is, pins with the same numbers are connected together:

1-1	2-2	3-3	4-4	5-5	6-6	7-7	8-8
-----	-----	-----	-----	-----	-----	-----	-----

If only the fixture and the computer are to be interconnected, no hubs or other active components are needed. A cross-cable has to be used:

1-3	2-6	3-1	4-8	5-7	6-2	7-5	8-4
-----	-----	-----	-----	-----	-----	-----	-----

Ethernet operation.

Connect the Ethernet inputs of all fixtures in the fixture chain with the network.

Use the menu "Artnet Settings " to set an IP address , artnet universe and artnet subnet on all fixtures (see the "Fixture address" menu).

The option "Activate Artnet mode" has to be confirmed in "Artnet Settings " menu on all fixtures.

Example:

(DMX address=1)

DMX address=273

IP address=002.168.002.004

Artnet Universe=1

Artnet Subnet=0

DMX address=137

IP address=002.168.002.003

Artnet Universe=1

Artnet Subnet=0

DMX address=1

IP address=002.168.002.002

Artnet Universe=1

Artnet Subnet=0

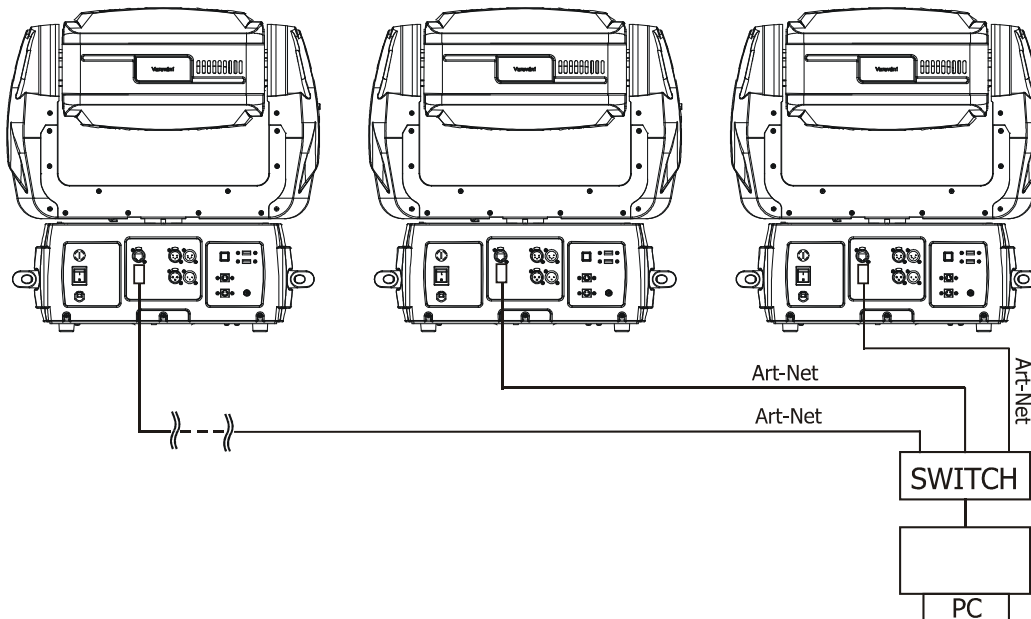

12. Folder organization

The library structure is reflected on the hard drive where all files for the library are stored. The whole library is contained within a special folder called 'Media'.

Inside the Media folder is a collection of folders (000,001...240) each named with a 3-digit number. Each folder following this convention represents a library folder and the 3-digit number represents the name of the folder. Because of this, you can't have folders without the 3 digit number scheme. You can't neither have two folders with the same digits.

Inside each folder is a collection of media files that the library folder holds. The media files also should follow the 3-digit conventions where a 3-digit number is followed by an underscore and a name e.g.: 001_testfile1.png.

Note that for media files the digit starts at 001_ since visual 0 is always considered as being empty.

The media files assigned to the DMX values can be sorted either in an **alphabetical** or **numerical order**. Default assigning is the alphabetical order. If you need to change this sorting, go to the menu "Personality" and select "Gobo selection mode" option.

The numerical order is suitable in the case that you need to exactly assign certain media files to specified DMX addresses.

The table below show differences in file→DMX assignment between the alphabetical and numerical sorting. The table also includes file names without a correct 3-digit convention to illustrate their behaviour in the numerical sorting.

Media file name	DMX value at Alphabetical Sorting	DMX value at Numerical Sorting
001_testfile1.png	1	1
020_testfile2.png	2	20
19_testfile3.png	3	19
3_testfile4.png	4	3
460_testfile5.png	5	Not Assigned*
testfile6.png	6	Not Assigned**

* The 3-digit number has to be in range of 001-255. If there is more than 255 media files in the folder, files above 255 are ignored.

** The media file name does not contain any digit.

Subfolders 000-020 are reserved for default gobos and videos (from factory) and their content cannot be changed.

The images and video clips can be in one of the following formats: bmp, jpg, tga; .png, gif, pcx, pnm, xpm and lbm for images and mpeg1, mpeg2 for videos.

The folder "Programs" serves for saving recorded DMX programs (dprg_01.csv,.....dprg_10.csv).

The folder named "Update" contains subfolders with the update files. The subfolders are created automatically during software updating and their names matching to date when software update has been executed.

The folder a "Log" serves for saving log files generate by the option "Generate Log File" in a menu "Special Functions" of the control panel. Log file names are deducated from the date when the file has been logged out.

Top level folder

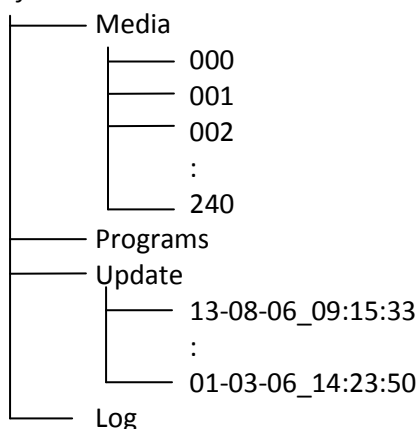

13. Control menu map

Default settings=**Bold print**

Menu Level 1	Menu Level 2	Menu Level 3	Menu Level 4	Menu Level 5	Menu Level 6	Menu Level 7	Menu Level 8
Fixture Address	DMX Settings	Set DMX Address	001-512				
		Activate DMX Mode					
	Ethernet Settings	Set IP Address	Default IP Address				
			Custom IP Address				
		Set ArtNet Universe	0-15				
		Set ArtNet Subnet	0-15				
		Activate Artnet Mode					
Fixture Information	DMX Values	Pan	0-255				
		:					
		Synchro to L3	0-255				
	Media Disk Space Usage	Free Disk Space					
		Used Disk Space					
	Software Version	Graphic Engine					
		IC1 Motherboard					
		IC2 Motherboard					
		IC3 Motherboard					
		IC1 HeadBoard					
	GPU Info:	GPU					
		Video Bios					
		Driver Version					
		Display Device					
	Product IDs	Mac Addr.					
		RDM UID					
Personality	Pan Reverse	On, Off					
	Tilt Reverse	On, Off					
	Lamp Presetting	Lamp On/Power On	On, Off				
		Lamp Off via DMX	On Off				

DigitalSpot 3000 DT

Menu Level 1	Menu Level 2	Menu Level 3	Menu Level 4	Menu Level 5	Menu Level 6	Menu Level 7	Menu Level 8
		Lamp On If DMX is Present	On, Off				
		Lamp Off if not DMX	On, Off				
	Display Adjusting	Display Permanent On					
			Display Off After 5 min				
			Permanent On				
		Display Orientation	Normal Orientation				
			Rotated Orientation				
	Pan/Tilt Feedback	On, Off					
	Pan/Tilt Mode						
		Time Mode					
		Speed Mode					
	Active Blackout While:	During Movement Cor.	OnOff				
		Pan/Tilt Moving	On, Off				
	Projection Presetting	Ceiling Projection	On, Off				
		Rear Projection	On, Off				
		Projector Refresh Rate	60Hz (Default)				
			50Hz				
	Dmx Protocol	Set DMX Mode	No Server				
			2 Layers				
			3 Layers				
		Protocol Version	Version 1.1				
			:				
			Version 1.4				
	Gobo Selection Mode	Alphabetical Order					
		Numerical Order					
	Microphone Sensitivity	1.. 10 ..20					
	Default Settings	Set Default Values					
		Remove User Media Content					
Lamp On/Off	On, Off						

DigitalSpot 3000 DT

Menu Level 1	Menu Level 2	Menu Level 3	Menu Level 4	Menu Level 5	Menu Level 6	Menu Level 7	Menu Level 8
Manual Control	Manual DMX Control	Pan	0-255				
		:					
		Synchro to L3	0-255				
	Video Input Selection	Internal Input					
		External Composite Input					
		External SVideo Input					
Stand-alone Setting	Play Program	Test program In Loop	Normal				
		Program 1	Static	Pan	0-255		
		:		Tilt	0-255		
		Program 10		Focus	0-255		
				Run Program			
	Edit Program	Program 1					
		:	Edit Steps	Step 1	Pan		
		Program 10		:	:		
				Step 99	Synchronization To ID		
					Step Time	0.1-25.5	
					Fade Time	0.1-25.5	
					Snap DMX		
					Save		
			Start Step	1-99	Save and Copy		
			End Step	1-99			
	Music Trigger	On, Off					
	Play DMX Program	DMX Program 1 in Loop					
		:					
		DMX Program 10 in Loop					
	Record DMX Program	DMX Program 1					
		:					
		DMX Program 10					
	Preset Playback	Deactivated					
		:					

DigitalSpot 3000 DT

Menu Level 1	Menu Level 2	Menu Level 3	Menu Level 4	Menu Level 5	Menu Level 6	Menu Level 7	Menu Level 8
		DMX Program 10 in Loop					
	Fixture Off Timer	Timer Deactivated					
		Time Activated					
		Set Timer Hours					
		Set Timer Minutes					
Preview Mode							
Reset Functions	Reset Graphics Engine						
	Reset Pan/Tilt System						
	Reset Focus/Shutter System						
	Reset All Systems						
Service Menu	Power On Time	Total Hours					
		Resetable Hours					
	Lamp On Time	Total Hours					
		Resetable Hours					
	Lamp Strikes	Total Strikes					
		Resetable Strikes					
	Fixture Temperatures	Current	Pan/Tilt Board				
			LED Panel Board				
		Maximum Nonresetable	Pan/Tilt Board				
			LED Panel Board				
		Maximum Resetable	Pan/Tilt Board				
			LED Panel Board				
	Air Filters	Time To Clean Up Filters					
		Set clean Up Timer	10..50..300				
Special Functions							
	Regenerate Thumbnails	Set Thumbnail size	50..96...300				

DigitalSpot 3000 DT

Menu Level 1	Menu Level 2	Menu Level 3	Menu Level 4	Menu Level 5	Menu Level 6	Menu Level 7	Menu Level 8
		Regenerate Thumbnails					
	FTP Server	Set Account					
		Allow Anonymous	Yes/No				
	HTTP Access	Set Account					
		Allow Anonymous	Yes/No				
	USB Data Synchronize	USB1	Open	Media	Open	000	Open
		USB2				:	Synchronize to Fixture
						240	Synchronize from Fixture
					Synchronize to Fixture		
					Synchronize from Fixture		
				Update	Open		
					Synchronize to Fixture		
					Synchronize from Fixture		
			Init Flash Disc				
	Software Update	Update Graphical Software					
		Update HW processors Software					
		Update Media Content					
	Calibrate Values	Analog Shutter Calib.	0-255				
		Tilt Calibration	0-255				
	Generate Log File						
	Remote Servis	Set Service IP Address	Remote IP Address	077.084.000.224			
			Remote Port	08283			
			Service Port	08290			
		Set Default Gateway	Gateway Address	002.001.001.001			
		Start Remote Service					
Fixture Off							

14. Operating modes

Before operating the DigitalSpot 3000 DT from a DMX 512 controller, you need to define the source of DMX data, which may be:

DMX 512 - data is transmitted over standard DMX cables. Set a valid DMX start address, which is defined as the first channel from which the DigitalSpot 3000 DT will respond to the controller.

Please, be sure that you don't have any overlapping channels in order to control each DigitalSpot 3000 DT correctly and independently from any other fixture on the DMX data link.

For DMX start address setting, please refer to the instructions under "Fixture Address".

ArtNet- data is transmitted over Ethernet network using ArtNet protocol. Set an IP address, ArtNet Universe and ArtNet Subnet.

For ArtNet setting, please refer to the instructions under "Fixture Address".

15. Control menu

The control panel situated on the front panel of the base offers several features. You can simply set the fixture addresses, configure the fixture, run test, make a reset and also use many functions for setting fixture behaviour.

Control elements on the control board:

[RNS] encoder wheel-moves between menu items on the same level, scrolls between values.

[ESC] button-leaves menu without saving changes

[ENTER] button-enters menu, confirms adjusted values and leaves menu

**After switching the fixture on,
the display shows the initial screen:**



**than press [ENTER] and
the display shows address:**

ARTNET MODE	
IP Address:	Fixture ID: 2.1.1.50
ArtNet Universe:	0
ArtNet Subnet:	0
DMX Address:	001

The main menu of the control panel is accessed by pressing the [ENTER] button. To browse through the menu, rotate the [RNS] wheel. To select a function or submenu, press the [ENTER] button.

15.1 Fixture Address

Use this menu to set the DMX address.

DMX Setting --- Select this submenu to set the DMX start address.

Set DMX Address - sets DMX address. After selecting desired DMX address confirm setting by using the function "Activate DMX Mode":

Activate DMX Mode - Data is received from DMX input.

ArtNet Setting --- Select this submenu to set the fixture for Ethernet operating.

Set IP Address - Select this submenu to set an IP address and NetMask.

The IP address is the Internet protocol address and uniquely identifies any node (fixture) on a network. There can't be 2 fixtures with the same IP address on the network!

Default IP Address -Preset IP address.

Custom IP Address - The option enables edit all numbers of the IP address.

To set the custom IP address:

1. Select „Custom IP Address” and press the [ENTER].

2. Use RNS wheel to set the first number of the IP address
 3. Press the [ENTER] to move on the second number of the IP address
 4. Repeat steps 2 and 3 for the third and fourth number of the IP address.
- If you want to return back on the previously edited number, press [ESC].
The same way you can set the Netmask Address.

Set ArtNet Universe - Select this submenu to set a Universe (0-15). The Universe is a single DMX 512 frame of 512 channels.

Set ArtNet Subnet - Select the option to set Ethernet subnetworks to which the fixture belongs (0-15)
After setting all Artnet parameters confirm setting by using the function "Activate Artnet Mode":

Activate Artnet Mode - Data is received from the Ethernet input.

15.2 Fixture information

DMX Values --- Select this item to read DMX values of each channel received by the fixture.

Media Disk Space Usage --- Select the item to read information about the hard disk space.

Free Disk Space --- Select the item to show a size of free hard disk space (MB).

Used Disk Space --- Select the item to show a size of used hard disk space (MB).

Software Version --- Select this function to read the software version of the fixture modules:

Graphic Engine - a graphic software of the fixture.

IC1 Motherboard - a processor IC1 on the main board in the fixture base (the IC1 controls communication, DMX, fans, temperatures).

IC2 Motherboard - a virtual EEPROM.

IC3 Motherboard - a processor IC3 on the main board in the fixture base (the IC3 controls pan, tilt, LEDs).

IC1 Headboard - a processor IC1 in the fixture head (the IC1 controls focus and shutter).

GPU Info --- Select the item to read information about graphics processing unit, drivers and type of the projector.

Product IDs --- Select the function to read the MAC address and the RDM UID code.

15.3 Personality

Use this menu to modify DigitalSpot 3000 DT operating behaviour.

Pan Reverse --- Select this function to invert the pan movement.

Tilt Reverse --- Select this function to invert the tilt movement.

Lamp Presetting --- Select this menu to change the lamp "behaviour".

Lamp On/Power On - Select this function to turn the projector's lamp on automatically after switching the fixture on.

Lamp Off via DMX - Select this function to switch the lamp off via DMX.

Lamp On if DMX Present - This function allows you to strike the lamp automatically after 26 seconds if a DMX signal is present on the data link.

Lamp Off if not DMX - This function allows you to switch off the lamp automatically after 2 minutes if a DMX signal is missing on the data link.

Display Adjusting --- This function allows you to change the display settings:

Display Permanent On - This function allows you to keep the display permanent on or

to turn it off after 5 minutes of inactivity of control buttons (wheel)

Display Orientation - Select this function to adjust the display orientation:

Normal orientation - A standard display orientation.

Rotated Orientation - Inverts the display by 180°.

Pan/Tilt Feedback --- This function allows to return the moving head to the required pan/tilt position after changing the position by an external force (e.g. by a stroke).

Be careful, the Pan/Tilt Feedback OFF is not the standard operation and the head of the fixture can be damaged!

Note: If the feedback was switched off, the pan/tilt position is changed by an external force and the feedback is switched on again, the moving head might not to be synchronized with the DMX signal. You have to make a reset in order to synchronize the moving head with the DMX signal.

Pan/Tilt mode --- Use this menu to set the character of the pan/tilt movement.

Time mode --- Pan and tilt will move with different speeds and they will come at the same time to the end point (pan and tilt sets its optimal speed).

Speed Mode --- Pan and tilt will move with the same speed as adjusted by the channel 5 (Pan/Tilt speed). E.g. pan will come to the end point and wait for tilt, which has longer track.

Active Blackout while: --- Use this function if you wish to close the light output during the following events:

During Movement correction --- Select this function to enable the blackout during the head movement correction (if the moving head lost its right pan/tilt position for a short moment).

Pan/Tilt Moving --- This function closes the light output during pan/tilt changing.

Projection Presetting --- Use this menu depending on the installation location of the fixture:

Ceiling Projection --- When this function is "On", a picture is top (bottom and left) right reversed. This function enables to project the image from a ceiling mounting of the DigitalSpot 3000 DT.

Rear projection --- When this function is "On", picture is left (right) reversed. This function enables to project the image to a rear projection screen.

Projector Refresh Rate --- Use this menu to change the output refresh rate of the DigitalSpot's projector from 60Hz to 50 Hz.

The function should be used in cases when output of DigitalSpot 3000DT is captured by the video cameras with a fixed 50Hz refresh rate and they are not allowed to adjust embedded 60Hz picture refresh rate of the DigitalSpot, in these cases some flickering would be visible in an image.

Note. All fixtures used in a show must have the same projector refresh rate setting.

DMX protocol --- Use this menu to set desired number of gobo/video layers and DMX channels.

Set DMX mode --- the item allow you to select a desired number of control channels

No Server --- the fixture uses first 17 control channels of DMX chart (1-17).

2 Layers --- 108 control channels (1-108).

3 Layers --- 136 control channels (1-136).

Protocol Version --- the item allow you to select a desired protocol version.

Gobo Selection Mode --- Use this menu to select desired sorting of media files in media subfolders.

Alphabetical Order --- The media files are assigned to DMX values in an alphabetical order.

Numerical projection --- The media files are assigned to DMX values in a numerical order.

Microphone Sensitivity --- Select this item to adjust the microphone sensitivity from 1 (maximum) to 20 (minimum).

Default Settings --- Select this option to set default values or to remove user's content in the fixture.

Set Default Values --- Select this option to reset all fixture personalities to the default values.

Remove User Media Content --- The item deletes all user media contents except the factory media content.

15.4 Lamp On/Off

Use this option in order to switch on/off the projector's lamp. Do not use the projector continuously for 24 hours or more. If using the projector continuously for long periods, turn it off and leave it for one hour at least once during a 24 hour period.

15.5 Manual control

Manual DMX control --- Select this menu to control all channels by the control elements on the control board.

Video Input Selection --- This menu enables to select desired video input:

- Internal input
- External SVIDEO Input

15.6 Stand-alone setting

Use this menu to set options for a stand-alone mode as a selection of the playing program, programming and modifying current programs.

Play program --- Select this menu to run a built-in program or 10 freely-programmable programs in a loop.

Test Program In Loop --- The option starts built-in test program.

Program 1 In Loop

:

Program 10 In Loop

} These options start user defined programs

Every program can run in two modes:

Normal - This mode uses pan/tilt movement and therefore is good for a dynamic projection.

Static - This mode is suitable for projections on the wall, ceiling or ground without any head movement. By means of items Pan, Tilt and Focus is possible to adjust moving head to the desired position.

Running program is possible to pause by pressing the [ENTER] button.

Edit Program --- Select this menu to edit or create a program. The DigitalSpot 3000 DT has 10 freely-programmable programs, each up to 99 steps. Each program step has a step time, during which effects last in a current step.

Procedure:

1. Select the program you want to edit ("Program 1" - "Program 10") and press the [ENTER] button.
2. Select "Edit Steps" menu and press [ENTER] button.
3. Select the desired program step ("Step 01" - "Step 99") and press [ENTER] button.
4. Select the desired item and press the [ENTER] button. Now you can edit a DMX value of selected item by the [RNS] encoder wheel
5. Press the [ENTER] to save adjusted value.
6. Select another effects (channels) and repeat steps 4 and 5.
7. Select "Save" or "Save and Copy" and press the [Enter] to confirm all adjusted values in a current step:

"Save" - saves the current prog. step

"Save and Copy" - saves and copies the current prog. step to the next prog. step.

Option "Snap DMX" - inserts current values from DMX to all effects (channels). It is very useful function, you don't have to adjust all effects to desired positions, all values are loaded from DMX.

8. Go to the next prog. step, press the [ENTER] and repeat this procedure (steps 4 and 7).

After creation of the program, you can simply reduce its length (by changing the start/end step) using either "Start Step" item or "End Step" item.

Music Trigger --- Select this item to enable the sound control of the running programs via the built-in microphone.

Play DMX Program --- Select this menu to run one of 10 programs which have been recorded via the menu “Record DMX program”. By pressing the [ENTER] you can switch the running program into the 3 following modes: Pause, Playing, Playing in Loop. The current program step is shown on the fixture display:

PLAYING DMX PROGRAM
Playing program: dprg_02.csv
Step: 27
Time: 00:00:02.632
P a u s e

PLAYING DMX PROGRAM
Playing program: dprg_02.csv
Step: 27
Time: 00:00:02.632
P l a y i n g

PLAYING DMX PROGRAM
Playing program: dprg_02.csv
Step: 27
Time: 00:00:02.632
P l a y i n g I n L o o p

Record DMX Program --- The menu allows to record DMX data that receives the fixture and then replay them again via the menu “Play DMX program”. There is a list of 10 programs for recording with unlimited steps each. Select desired program number and press the [ENTER] to enter the recording screen.

RECORDING PROGRAM
Recording program: dprg_02.csv
Step: 11
Time: 00:00:01.234
R e c o r d i n g

The data record starts after changing any receiving DMX value. To stop recording, press [ENTER] or [ESC]. Recorded DMX program has the name **dprg_xx.csv** where the xx means the number of the program (e.g. dpr_01.csv, dprg_02.csv....) and is stored in the folder “Programs” accessible by means of FTP. The format of this file is a plain text that allows additional user editing. The first line of the file includes all DMX channels with their starting DMX values and the next lines display changes of DMX values of channel effect and a relevant time of the changes.

Note: If you select the program which contains previously recorded data, the data will be overwritten without warning.

Preset playback --- The menu allows to select a program (or a DMX program), which will be played automatically in a loop after switching the fixture on.

Fixture Off Timer --- The menu offers to control the time during which the fixture is on and, for example, plays the recorded program. The adjusted time period is counted from starting the fixture.

Timer Deactivated --- The item disables the “Fixture Off Timer” option.

Timer Activated --- Activate timer is signalled by the small icons at the top right corner of the screen.

Set Timer Hours --- The item enables to set hours for the “Fixture Off Timer”.

Set Timer Minutes --- The item enables to set minutes for the “Fixture Off Timer”.

15.7 Preview mode.

This item enables to display the image, going from the projector, on the fixture’s display.

Note: If this function is called out, the video sequence from projector will not be played continuously because the fixture’s processor has to display this sequence twice at the same time (on the wall and on the display)

15.8 Reset functions

The DigitalSpot 3000 DT can be reset totally or in function modules. Select a desired function to run a reset:

Reset Graphics Engine --- This function resets a graphics engine.

Reset Pan/Tilt System --- This function resets a pan/tilt movement.

Reset Focus/Shutter system --- This function resets a focus module.

Reset All systems --- This function enables you to return all fixture’s effects to their standard positions.

15.9 Service menu

Use this menu to read useful information about the fixture.

Power On Time - Select this submenu to read the number of operation hours of the fixture.

Total Hours - The function shows the total number of the operation hours since the DigitalSpot 3000 has been fabricated.

Resetable Hours - The function shows the number of the operation hours that the DigitalSpot 3000 has been powered on since the counter was last reset. In order to reset this counter to 0, press [ENTER] twice.

Lamp On Time - Select this submenu to read the number of the operation hours with the projector lamp on.

Total Hours - The function shows the total number of the operation hours with the lamp on since the DigitalSpot 3000 has been fabricated.

Resetable Hours - The function shows the number of the operation hours with the lamp on that the DigitalSpot 3000 has been powered on since the counter was last reset. In order to reset this counter to 0, press [ENTER] twice.

Lamp Strikes - Select this submenu to read the total number of the projector lamp strikes.

Total Hours - The function shows the total number of the lamp strikes since the DigitalSpot 3000 has been fabricated.

Resetable Hours - The function shows the number of the lamp strikes since the counter was last reset. In order to reset this counter to 0, press [ENTER] twice.

Fixture Temperatures --- Select this submenu to read the temperatures of the projector:

Current - Select this function to read the current temperatures of the fixture interior .

Maximum nonresetable -The function shows the max. temperatures of the fixture interior since the DigitalSpot 3000 DT has been fabricated.

Maximum resetable - The function shows the maximum temperatures of the fixture interior since the respective counter was last reset. In order to reset desired counter to 0, press [ENTER] twice.

Measuring points of temperatures:

Pan /Tilt Board. [°C]temperature on the PCB in the fixture base

Led Panel Board [°C].....temperature in the LED module

Air Filters --- Regular cleaning of the air filters is very important for the DigitalSpot 3000 DT life and performance. Buildup of dust, dirt and fog fluid residues reduces the fixture's light output and cooling ability. The two items of menu help you to keep cleaning period of the air filters.

Time To Cleanup Filters - The option allows you to read the time which remains to cleaning air filters. Expired time period is signaled by a negative mark at the time value and a warning icon (triangle) on the display with the following message:

"Please , Clean Up Airs Filters."

Clean the filters and reset this menu item (by pressing the "Enter" button twice while this menu is highlighted)

Set Cleanup Timer - Cleaning schedule for the fixture depends on the operating environment. It is therefore impossible to specify accurate cleaning interval. This function allows you to change the cleaning interval of the air filters. This "reminder" value is 50 hours and it is set as default. Inspect fixture within its 50 hours of operation to see whether cleaning is necessary. If cleaning is required, clean all air filters and change the value in this menu on acceptable level. Min. level is 10 hours, max. is 300 hours.

15.10 Special functions

Use this menu for special services like remote servis or software update.

Regenerate Thumbnails --- Use the menu to manage thumbnails behaviour.

Set Thumbnail size - The menu item allows set the size of the thumbnail: 50-min.size,

300-max.size.

Regenerate Thumbnails - By pressing the "Enter" button the refreshing process of gobo/video thumbnails starts. This action should be performed if you have changed gobo/video files and the fixture was not switched off after the change, otherwise the refreshing process runs automatically at starting up of the DigitalSpot 3000 DT.

FTP Server --- The FTP (File Transfer Protocol) server is used to transfer files between the fixture and a PC over an ethernet network by means of FTP client running on your PC. The "FTP Server" menu allows control of an access to the fixture's folders.

Set Account - The option allows you to protect the access to the fixture folders by setting the name and password. The same data must be entered in FTP terminal running on your PC.

Allow Anonymous - If this option is set "Yes", no password is required in FTP terminal but the user name may be "ftp" or "anonymous".

HTTP Access --- This menu enables to set access privileges which are used at entering to the Remote control program via your WWW browser.

Set Account - The option allows you to protect the access to the Remote control program by setting the name and password. The same data must be used in the Remote control program running on your PC or a light control console.

Allow Anonymous - If this option is set "Yes", no password is required at entering to the Remote control program.

USB Data Synchronization --- The menu allows transfer of media files (images, videos) and software files between the USB stick and fixture's hard disk and related operations.

The USB stick must contain the following folders structure:

Top level folder

Media
000
001
002
:
240
Programs
Update
Log

:

To create the folders structure mentioned above, use the option "**Init Flash Disc**". After creating folders structure on the USB stick you may load/download files into folders/subfolders. Maximum number of media files in one Media subfolder is 240. **Subfolders 000-020 are reserved for default images/videos and cannot be changed (you cannot copy media files into these subfolders).**

To upload a file/folder from the USB stick to the Media folder in the fixture:

1. Insert the USB stick to the USB port, select "**USB Data Synchronize**" from the menu and press the [ENTER], "**USB1**" or "**USB2**" (depends on used USB port) is displayed on the screen.
2. Press the [ENTER], select "**Open**", press the [ENTER].
3. Select "**Media**", press the [ENTER].
4. If you want to copy all Media folder (including subfolders 000-240), select item "**Synchronize to Fixture**". If you want to copy only one subfolder (e.g. 035), select "**Open**", press the [ENTER], select desired subfolder from a list of subfolders, press the [ENTER] and select option "**Synchronize to Fixture**". If you want to copy only one file, select "**Open**" and press the [ENTER]. Select the desired file, press the [ENTER] and confirm a question in a dialogue box.

To download folder from the Media folder to the USB stick.

1. Insert the USB stick to the USB port, select "**USB Data Synchronize**" from the menu and press the [ENTER]. "**USB1**" or "**USB2**" (depends on used USB port) is displayed on the screen.
2. Press the [ENTER], select "**Open**", press the [ENTER].

3. Select **Media** , press the [ENTER],
4. If you want to copy all Media folder from the fixture (including subfolders 000-240), select item "**Synchronize from Fixture**". If you want to copy only one subfolder (e.g. 035) ,select "**Open**", press the [ENTER] , select desired subfolder from a list of subfolders ,press the [ENTER] and select option "**Synchronize from Fixture**". If you want to copy only one file, select "**Open**" and press Enter. Select the desired file, press the [ENTER] and confirm a question in a dialogue box.

Software Update --- This menu allows to update graphical software or hardware processors software. You have to download the latest version of the DigitalSpot 3000 DT software from ROBE website to your hard disk and then use either Ethernet network or the USB stick to move this file to the relevant folder in the DigitalSpot 3000 DT.

Copying software update file from the USB stick to the fixture:

1. Insert the USB stick to the USB port, select "**USB Data Synchronize**" from the menu and press Enter. There is an **USB1** or **USB2** (depends on used USB port) displayed on the screen.
2. Press Enter, select **Open**, press the [ENTER].
3. Select **Update** and press the [ENTER]. If you want to upload whole Update folder to the fixture, select option "**Synchronize to Fixture**".

If you only want to copy one or more files to the fixture, select option "**Open**" and press the [ENTER]. Select desired file, press the [ENTER] and confirm a question in a dialogue box.

After copying update file to the fixture, the desired software update will be activated by confirming the follow items:

Update Graphical Software - starts update of the graphical software.

If the message *Please Update HW Processors in Menu "Special Functions"* will appear after updating, run update of the hardware functions.

Update HW processors Software - starts update of hardware functions like pan, tilt, focus...etc.

Update Media Content - starts update of the factory media folders 00-20 (pictures, videos)

Calibrate Values --- This menu serves for a fine calibration of effects.

Analog Shutter - allows ine calibration of a mechanical shutter (projector lamp has to be turned on).

Tilt Calibration -allows fine calibration of a tilt.

Generate Log File --- This item starts generating a log file. The file is saved in a folder "Log" on the hard disk. This file records events in a certain scope in order to provide an audit trail that can be used to diagnose problems of the fixture.

Remote servis --- This menu provides necessary items for remote servis of the DigitalSpot 3000 DT.

15.11 Fixture Off

This function shuts down the fixture. The projector lamp is switched off as first and after cca 20 seconds is switched off the fixture.

16. Keystones

If an image is output from the DigitalSpot 3000 DT at an angle the image may be skewed. Eight keystones adjust the image shape.It is possible to control each of the four corners of the image and reshape it. Default DMX value is 0, it means that no keystone correction has been used.

DigitalSpot 3000 DT

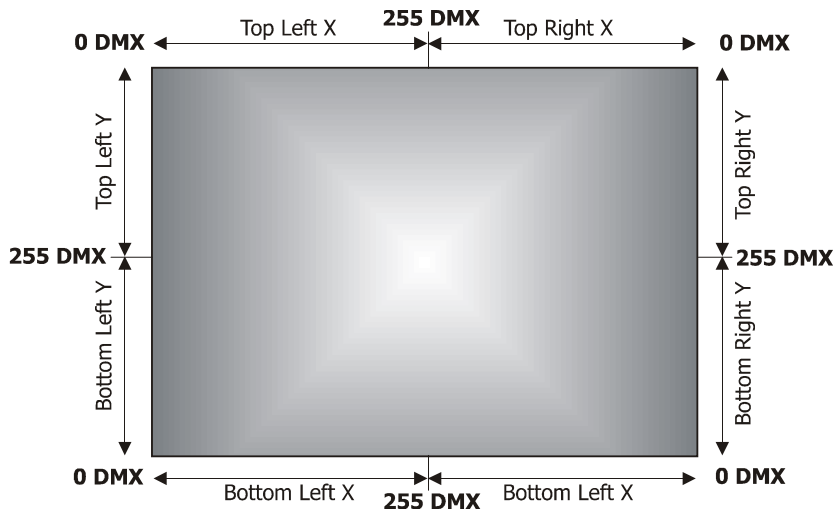

Setting all keystone values to 0 will place all four corners of the image at the four corners of the projector output. The keystone values can also be used to create interesting skewing effects.

For the picture merging are important both the **Keystone X-ratio** and **Keystone Y-ratio** channels for correction of the image distortion caused by placing projectors at different distances from the final image:

use channel **Keystone X-ratio** for correction

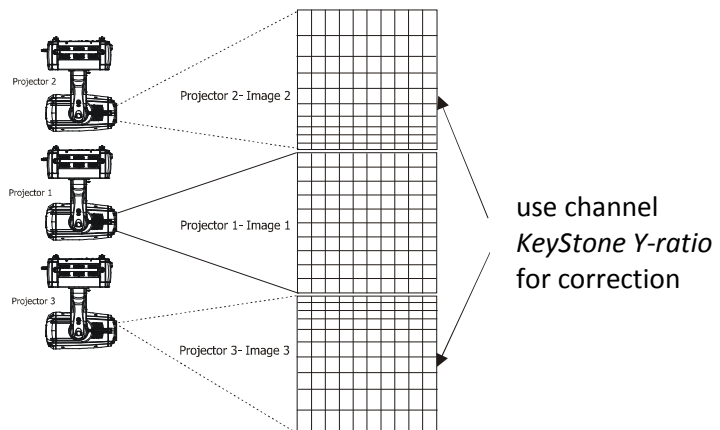
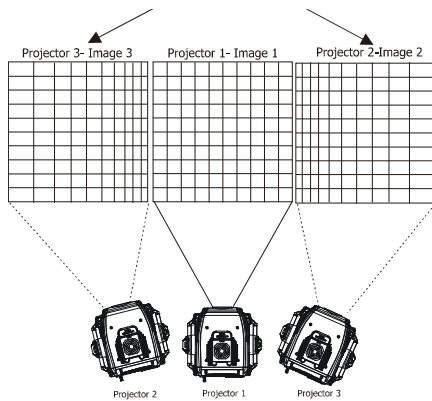

17. In Frame and Out Frame parameters

You can select any segment of a video file for playback by assigning parameters for In Frame (start point) and an Out Frame (end point) as pictured below.

The In Frame parameter corresponds to a 16-bit DMX value equal to a starting point for the playback segment of the selected video file. The Out Frame parameter corresponds to a 16-bit DMX value equal to an end point for the playback segment of the selected video file.

1. Assigning the In Frame DMX values to 0 and Out Frame DMX values to 255 you will playback the entire video file.

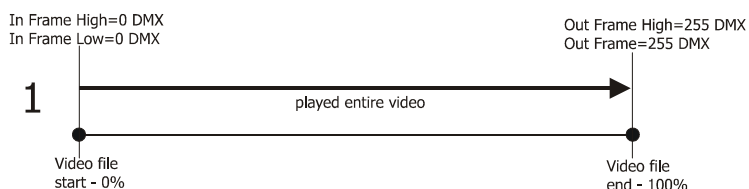

2. You can create a segment anywhere between the beginning and the end of the video file.

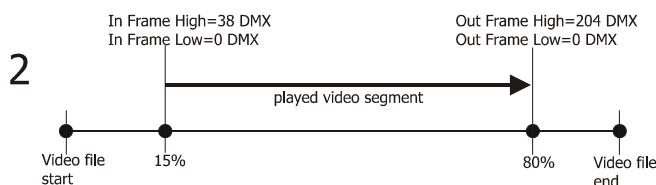

3. It is possible to skip a segment in the video file by setting the In Frame to a point following the Out Frame value.

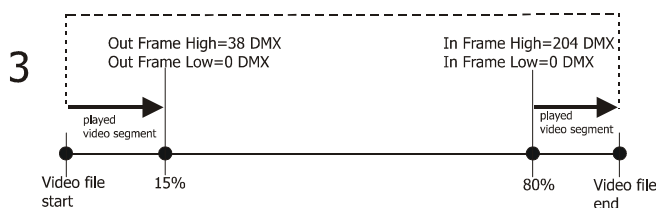

18. Video Control

The channel **Gobo control** defines how the current layer will be 'composed' with the previous layers and the playback options in each mode. The Digital Spot 3000 supports the following options:

Copy mode (0-17 DMX): In this mode, the pixels of the layer are written on top of the previous layers.

Addition mode (20 37 DMX): In this mode, the pixel values of the current layer are added to the ones of the previous layers. This means that "dark" pixels in the current layer image won't alter the pixels that are underneath while "light" pixel will saturate the image underneath.

Subtraction mode (40 47DMX): In this mode, the pixel values of the current layer are subtracted from the pixel value in the underlying layers. Dark pixel from the current layer won't alter the pixel of the layers underneath while light pixel will darken them.

Multiplication mode (60 77 DMX): In this mode, the pixels from the current layer will be multiplied by the pixels of the underlying layers. For a pixel to appear bright in the output, the equivalent pixel of the current layer and the underlying layer needs to be bright. If any of the layers has a dark pixel, the result will be dark.

Minimum mode (80 97 DMX): This mode takes the pixel that is the darkest between the current layer and the layer underneath

Maximum mode (100-117 DMX): This mode takes the pixel that is the brightest between the current layer and the layer underneath.

The playback options:

<u>DMX value</u>	<u>Playback options</u>	<u>Meaning</u>
0.	Play forward continuously if dimmer >0	Plays the video segment from In Frame point to Out Frame point, continuous looping. The dimmer value has to be greater than 0.
1	Play forward once if dimmer >0	Plays the video segment from In Frame point to Out Frame point and holds on the last frame. The dimmer value has to be greater than 0.
2	Pause	Stops playback of video file at the current playing
3	Play forward in continuous loop	Plays the video segment from In frame point to Out Frame point, looping continuously frame
4	Play forward once	Plays the video segment from In Frame point to Out Frame point and holds on the last frame
6	Scrub (display) the selected In Frame	Displays the frame which has been defined by the In Frame value.
7	Scrub (display) the selected Out Frame	Displays the frame which has been defined by the Out Frame value.

19. Playback speed

The **Playback speed** channel controls the speed of video playback at selected playback options.











<u>DMX value</u>	<u>Playback speed</u>	<u>Meaning</u>
0 or 128	Normal speed	Plays back video files at the original record. speed
1-127	Slow speeds from slowest to normal	Plays back video files at an increasing speed, from the slowest to the original recorded speed
129-255	Faster than normal to fastest	Plays back video files at an increasing speed, from faster than normal to the fastest

20. Graphic effects

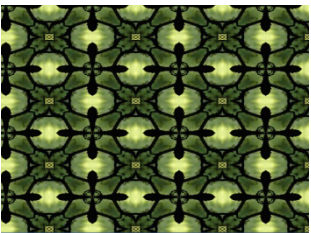
There are two gobo effect channels on each gobo layer (**Gobo effect 1 selection**, **Gobo effect 2 selection**), which offer amount of effects that can be applied to the current running picture/video. Each effect channels have three control channels - **Parameter 1**, **Parameter 2**, **Parameter 3** – which allow to change the behaviour of selected effect (e.g. speed, amount...)

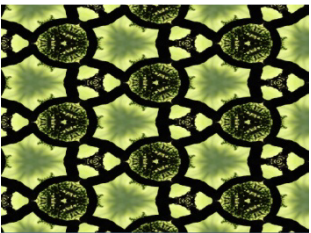
20.1 Kaleidoscopic effect

The kaleidoscopic effect section on the channel **Gobo effect 1 selection** allows selection of the static or dynamic mode of the kaleidoscopic effect according to the desired mosaic segment.

DMX value		Segment of mosaic	Example	Source picture
Static mode	Dynamic mode			
100	101	Square 		
102	103	Right triangular 		
104	105	Isosceles triangular 		
106	107	Triangular 1 		
108	109	Triangular 2 		

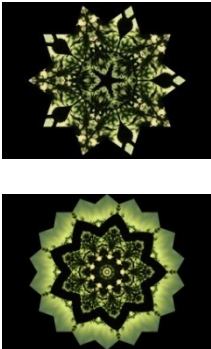
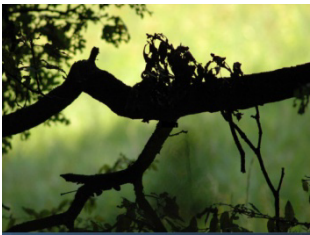
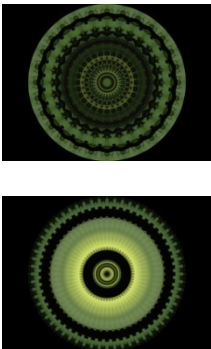
DMX value		Mosaic effect	Examples	Source picture
Static mode	Dynamic mode			
110	111	<p>Centered Kaleidoscope (rough)</p> <p><i>Note: As the effect does not cover all projection are, the image from the lower layer can be displayed at the sides of the effect.</i></p> <p><i>E.g. Centered Kaleidoscope effect has been selected on the layer 4 and the picture on the layer 3 is visible at the sides of the effect.</i></p>		
112	113	<p>Centered Kaleidoscope (fine)</p> <p><i>Note: As the effect does not cover all projection are, the image from the lower layer can be displayed at the sides of the effect.</i></p> <p><i>E.g. Centered Kaleidoscope effect has been selected on the layer 4 and the picture on the layer 3 is visible at the sides of the effect.</i></p>		

Meaning of the control channels depends on the kaleidoscope mode which has been selected:

Static mode.

Gobo effect 1- Parameter 1: Density of mosaic segments

DMX value	Function
0 - 255	Density of mosaic segments from large (0 DMX) to small (255 DMX)

If the effect “Centered Kaleidoscope (rough)” is selected, meaning of the **Parameter 1** is the following:

DMX value	Function
0 - 255	Shape (diamond (0 DMX) → circle (255 DMX)) and a number of mirroring planes

Gobo effect 1- Parameter 2: Content of segments-coarse

DMX value	Function
0 - 255	Coarse adjustment of the segments content

Gobo effect 1- Parameter 3 : Content of segments-fine

DMX value	Function
0 - 255	Fine adjustment of the segments content

Dynamic mode.

Gobo effect 1- Parameter 1: Density of mosaic segments

DMX value	Function
0 - 255	Adjusting density of mosaic segments from large (0 DMX) to small (255 DMX)

If the effect “Centered Kaleidoscope (fine) ” is selected, meaning of the **Parameter 1** is the following:

DMX value	Function
0 - 255	Shape and a number of mirroring planes

Gobo effect 1- Parameter 2: Size and pulsation of the segments content

DMX value	Function
0 - 128	Size of segments content from small (0 DMX) to large (128 DMX)
129 - 255	Speed of segment pulsation from slow (129 DMX) to fast (255 DMX)

Gobo effect 1- Parameter 3: Movement of the segments content

DMX value	Function
0 - 127	Backward movement of segments content from fast (0 DMX) to slow (127 DMX)
128	No movement
129-255	Forward movement of segments content from slow (129 DMX) to fast (255 DMX)

20.2 Circular effect (Fish eye)

The effect allows to convert a picture from an oblong format to a circle format and adjust the character of the circular effect.

The circular effect can be activated on each gobo layer if you set the **Gobo Effect 1 Selection** channel to a DMX Value of 90. The **Parameter 1** of this effect changes the character of the circular effect from concave to convex. The **Parameter 2** and **Parameter 3** serve for adjusting X ratio and Y ratio of the source image. A default value for all three parameters is 128.

Control parameters:

Control parameter	Controlled item	DMX value	Function
Parameter 1	Character of the circular effect	0-255	concave (0)→ no adjustment (128) → convex (255)
Parameter 2	X-ratio of the image	0-255	continual adjustment
Parameter 3	Y-ratio of the image	0-255	continual adjustment

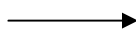

20.3 RGB (CMY) effects

The RGB effects section on the channel **Gobo effect 2 selection** allows to apply a variety of RGB colour swapping effects to graphic objects.

RGB subtract All Pixels (DMX value=50) – the effect reduces colour values across all pixels.

Associated control parameters:

Control parameter	Controlled item	DMX value	Function
Parameter 1	Red colour element	0-255	no adjustment → minimum saturation
Parameter 2	Green colour element	0-255	no adjustment → minimum saturation
Parameter 3	Blue colour element	0-255	no adjustment → minimum saturation

RGB add All Pixels (DMX value=51) – the effect increases colour values across all pixels.

Associated control parameters:

Control parameter	Controlled item	DMX value	Function
Parameter 1	Red colour element	0-255	no adjustment → maximum saturation
Parameter 2	Green colour element	0-255	no adjustment → maximum saturation
Parameter 3	Blue colour element	0-255	no adjustment → maximum saturation

RGB add non-black Pixels (DMX value=52) – the effect increases colour values across all pixels except black pixels.

Associated control parameters:

Control parameter	Controlled item	DMX value	Function
Parameter 1	Red colour element	0-255	no adjustment → maximum saturation
Parameter 2	Green colour element	0-255	no adjustment → maximum saturation
Parameter 3	Blue colour element	0-255	no adjustment → maximum saturation

RGB subtract/add All Pixels (DMX value=53) – the effect reduces/ increases colour values across all pixels.

Associated control parameters:

Control parameter	Controlled item	DMX value	Function
Parameter 1	Red colour element	0-255	Min. saturat. (0) → no adjustment (128) → max. saturation(255)
Parameter 2	Green colour element	0-255	Min. saturat. (0) → no adjustment (128) → max. saturation(255)
Parameter 3	Blue colour element	0-255	Min. saturat. (0) → no adjustment (128) → max. saturation(255)

Swap RGB to RBG (DMX value=54) – the effect swaps green and blue colour in all pixels. Red colour remains without change.

Associated control parameters:

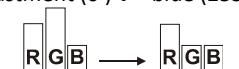
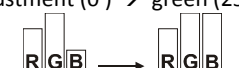
Control parameter	Controlled item	DMX value	Function
Parameter 1	Red colour element	0-255	No change.
Parameter 2	Green colour element	0-255	no adjustment (0) → blue (255) 
Parameter 3	Blue colour element	0-255	no adjustment (0) → green (255) 

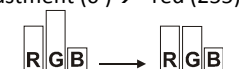

Swap RGB to GRB (DMX value=55) – the effect swaps red and green colour in all pixels. Blue colour remains without change.

Associated control parameters:

Control parameter	Controlled item	DMX value	Function
Parameter 1	Red colour element	0-255	no adjustment (0) → green (255) 
Parameter 2	Green colour element	0-255	no adjustment (0) → red (255) 
Parameter 3	Blue colour element	0-255	No change.

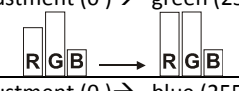
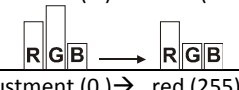

Swap RGB to GBR (DMX value=56) – the effect swaps red to green, green to blue and blue to red colour in all pixels.

Associated control parameters:

Control parameter	Controlled item	DMX value	Function
Parameter 1	Red colour element	0-255	no adjustment (0) → green (255) 
Parameter 2	Green colour element	0-255	no adjustment (0) → blue (255) 
Parameter 3	Blue colour element	0-255	no adjustment (0) → red (255) 

Swap RGB to BRG (DMX value=57) – the effect swaps red to blue, green to red and blue to green colour in all pixels.

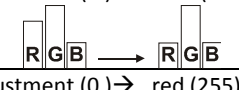
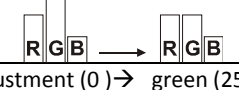
Associated control parameters:

Control parameter	Controlled item	DMX value	Function
Parameter 1	Red colour element	0-255	no adjustment (0) → blue (255) 
Parameter 2	Green colour element	0-255	no adjustment (0) → red (255) 
Parameter 3	Blue colour element	0-255	no adjustment (0) → green (255) 

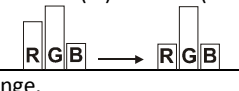
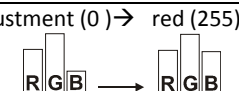

Swap RGB to BGR (DMX value=58) – the effect swaps red and blue colour in all pixels. Green colour remains without change.

Associated control parameters:

Control parameter	Controlled item	DMX value	Function
Parameter 1	Red colour element	0-255	no adjustment (0) → blue (255) 
Parameter 2	Green colour element	0-255	No change.
Parameter 3	Blue colour element	0-255	no adjustment (0) → red (255) 

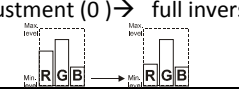

RGB invert (DMX value=59) – the effect inverts red, green and blue colour in all pixels.

Associated control parameters:

Control parameter	Controlled item	DMX value	Function
Parameter 1	Red colour element	0-255	no adjustment (0) → full inversion (255) 
Parameter 2	Green colour element	0-255	no adjustment (0) → full inversion (255) 
Parameter 3	Blue colour element	0-255	no adjustment (0) → full inversion (255) 

Invert and swap RGB to BRG (DMX value=60) – the effect swaps red, green and blue colour to inverted BRG in all pixels.

Associated control parameters:

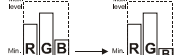
Control parameter	Controlled item	DMX value	Function
Parameter 1	Red colour element	0-255	no adjustment (0) → full inverted blue (255) 
Parameter 2	Green colour element	0-255	no adjustment (0) → full inverted red (255) 
Parameter 3	Blue colour element	0-255	no adjustment (0) → full inverted green (255) 

Invert and swap RGB to GBR (DMX value=61) – the effect swaps red, green and blue colour to inverted GBR in all pixels.

Associated control parameters:

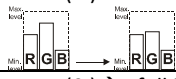
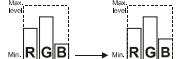
Control parameter	Controlled item	DMX value	Function
Parameter 1	Red colour element	0-255	no adjustment (0) → full inverted green (255) 
Parameter 2	Green colour element	0-255	no adjustment (0) → full inverted blue (255) 
Parameter 3	Blue colour element	0-255	no adjustment (0) → full inverted red (255) 

Colour to Alpha (DMX value=62) – the effect changes the transparency level of an image's element colour values. You can adjust the transparency of individual colours from completely transparent to full opacity using the control parameters 1, 2 and 3:

Control parameter	Controlled item	DMX value	Function
Parameter 1	Red colour element	0-255	Changes the red colour element transparency
Parameter 2	Green colour element	0-255	Changes the green colour element transparency
Parameter 3	Blue colour element	0-255	Changes the blue colour element transparency

Colour to Alpha Inverted (DMX value=63) – the effect changes the transparency level of the inverse of an image's element colour values.

Associated control parameters:

Control parameter	Controlled item	DMX value	Function
Parameter 1	Red colour element	0-255	Changes the inverted red colour element transparency
Parameter 2	Green colour element	0-255	Changes the inverted green colour element transparency
Parameter 3	Blue colour element	0-255	Changes the inverted blue colour element transparency

DigitalSpot 3000 DT

RGB scale (DMX value=68) – the effect changes the output intensity of red, green and blue colour in all pixels.

Associated control parameters:

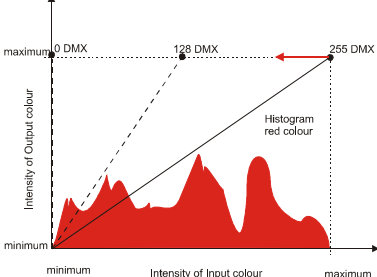
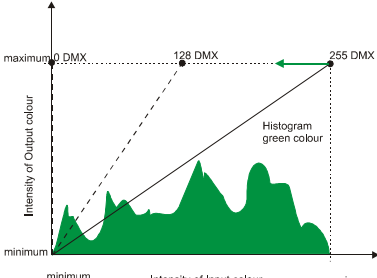
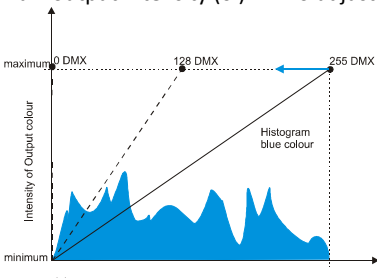
Control parameter	Controlled item	DMX value	Function
Parameter 1	Red colour	0-255	Changes the inclination of conversion line for red colour from max. output intensity (0) → no adjustment (255) 
Parameter 2	Green colour	0-255	Changes the inclination of conversion line for green colour from max. output intensity (0) → no adjustment (255) 
Parameter 3	Blue colour	0-255	Changes the inclination of conversion line for blue colour from max. output intensity (0) → no adjustment (255) 

Brightness scale (DMX value=69) – the effect changes the output intensity of brightness of the picture.

Associated control parameters:

Control parameter	Controlled item	DMX value	Function
Parameter 1	Inclination of the conversion line – bottom point	0-255	Changes the inclination of conversion line for output brightness from no adjustment (0) → min. brightness (255)
Parameter 2	Inclination of the conversion line – top point	0-255	Changes the inclination of conversion line for output brightness from max. brightness (0) → no adjustment (255)

Example:

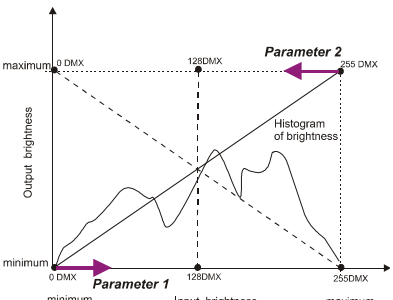

21. Media content management

As you seen earlier in chapter "12. Folder organization", the DigitalSpot 3000 DT uses the root folder named "Media". This folder contains subfolders (000,001...240) and inside each subfolder is the collection of media that the subfolder holds. The files in subfolders are sorted in an alphabetic or numerical order and assigned to DMX. The first part of the file name should be a 3-digit number followed by an underscore and a name e.g.:

001_sun..... 1 DMX

002_snow_castle.....2 DMX

:

255_apple.....255 DMX

Subfolders 000-020 are reserved for default (factory) gobos/videos and cannot be changed.

User subfolders 21-240 and their contents can be mowed between fixtures and your local drive (PC) as well as between fixtures. Which method you use depends on:

- how much content you want to move
- whether the fixture is currently connected to the Ethernet fixture link

There is several methods for moving user content files and folders between fixtures and a local drive and between fixtures each other. You can use:

- FTP client in Windows explorer window (fixtures have to be connected to Ethernet link)
- FTP client in Mozilla Firefox (fixtures have to be connected to Ethernet link)
- USB stick
- option "Contents Synchronization" in a Remote control program (fixtures have to be connected to Ethernet link).

For detail description see articles below.

21.1 Moving files between the fixture and a PC

1. FTP client in explorer window

All fixtures have to be linked to the Ethernet link. The proper network configuration and IP address setting of your PC is very important. The following is an example of an IP setting for Windows XP :

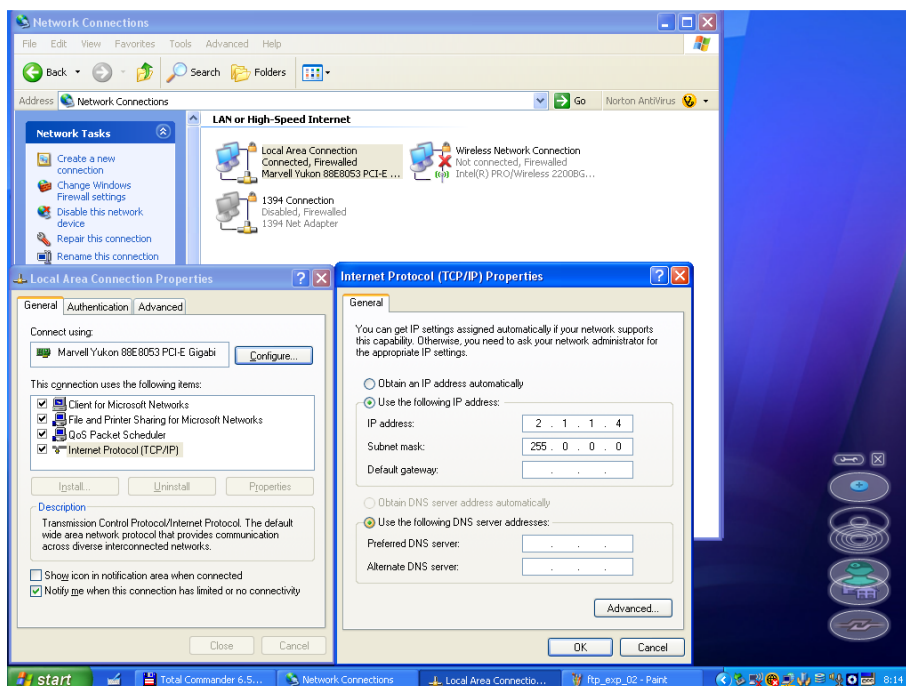

DigitalSpot 3000 DT

After network configuration, type the IP address of the DigitalSpot 7000 DT in address line in your Windows explorer window. Use this format **ftp:// 2.X.X.X /** (e.g. ftp://2.236.2.88/- see picture below).

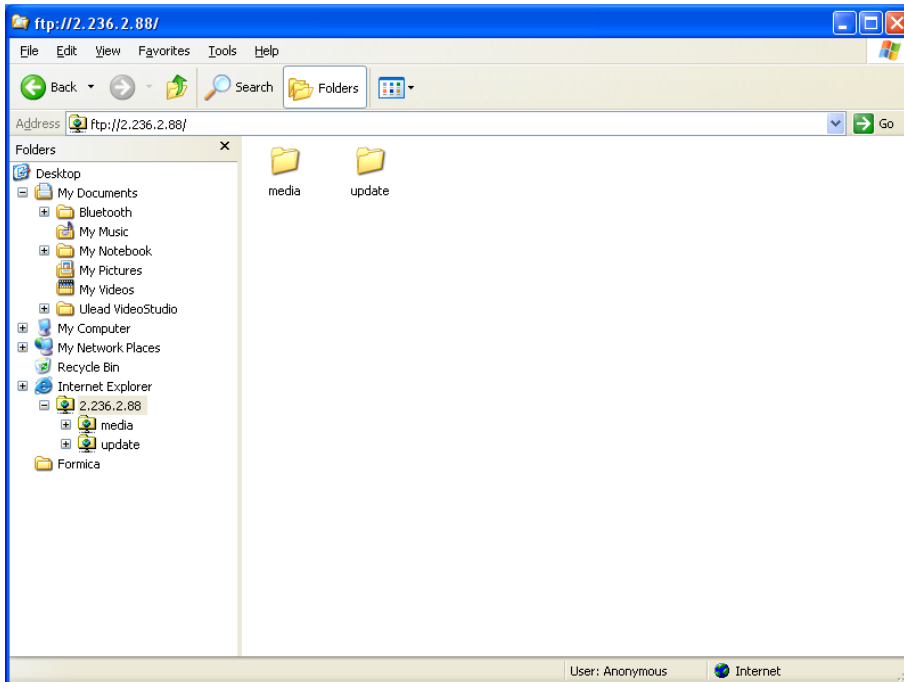

If all settings are proper, you will see "Media" and "Update" folders in the Windows explorer window and now you can work with them as local folders and files.

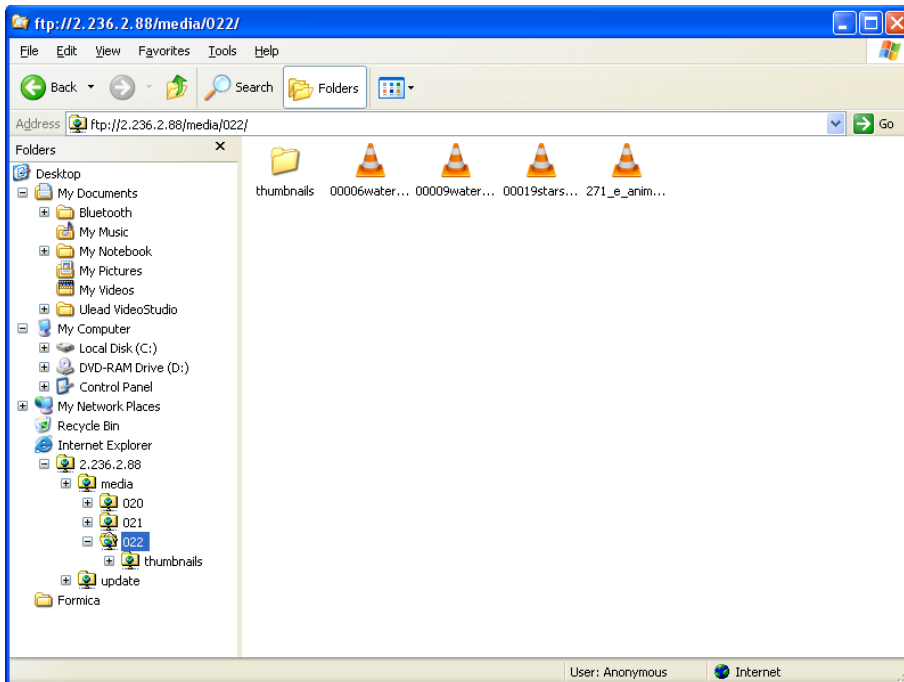

See also "Special functions"--> "FTP Server".

2. FTP client in Mozilla Firefox

If you use Mozilla Firefox as your web browser, you can install FTP client into the browser. To install FTP client for Mozilla Firefox on your computer.

1. Run Mozilla Firefox.
2. Select option “Tools” from the Menu bar, select “Add-ons” item.

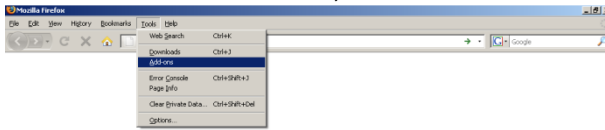

3. Select option “Get Add-ons” from the standard toolbar, type **fireftp** into the top left field and press Enter key.
4. Click on the Add to Firefox.. button and follow the installation instructions.

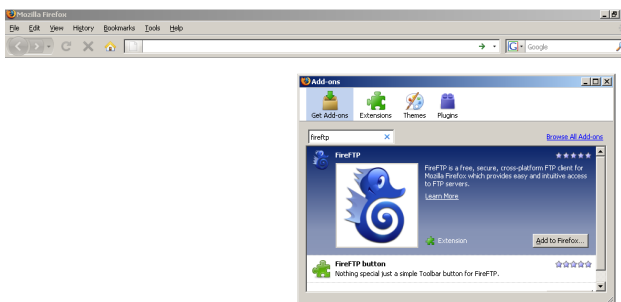

5. Follow the installation instructions until the installation has finished.

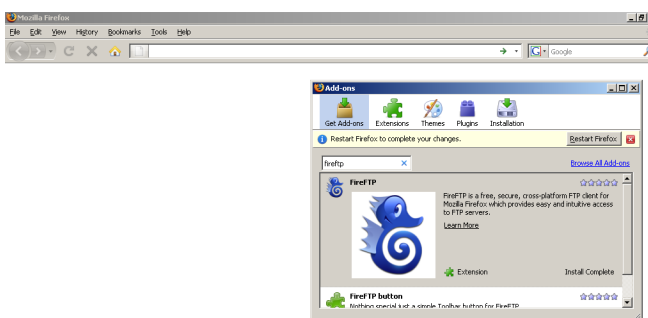

5. After installation, go to the “Tools”, select “Add-ons” item, select “Extensions” in the toolbar and click on the Options button. Select “Interface” menu and check option “**Configure FTP links in Firefox to automatically use FireFTP**”.

DigitalSpot 3000 DT

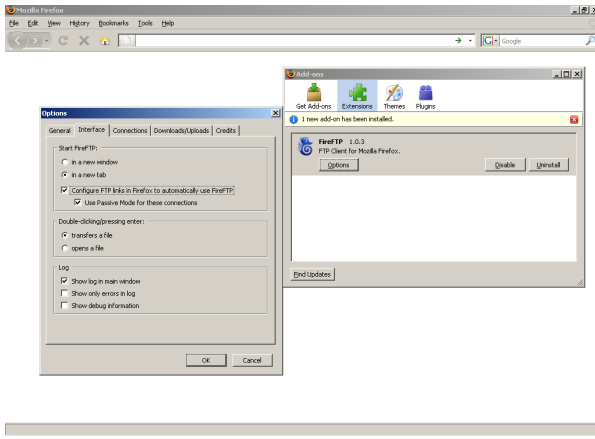

After installing FTP client, run Mozilla Firefox and type the IP address of desired fixture in ftp format e. g. **ftp://2.97.181.89** and a Fire FTP window will appear.

If you do not want to keep in mind IP addresses of all connected fixtures, you can use the Remote configuration program (by typing the IP address of one fixture to the web browser in http format e. g. **http://2.97.181.89**) and go to the Contents Synchronization window where a list of available fixtures is offered.

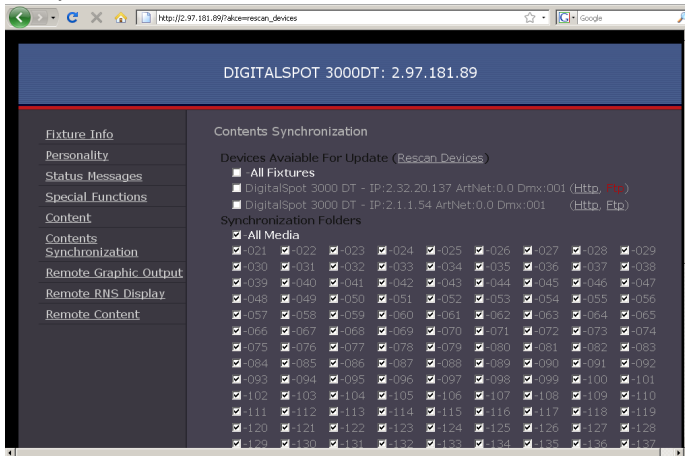

You need to know only IP address of one fixture as the rest of connected fixtures with their IP addresses is displayed in this window. By clicking on the Ftp option (in parenthesis) at desired fixture the FireFTP window will appear:

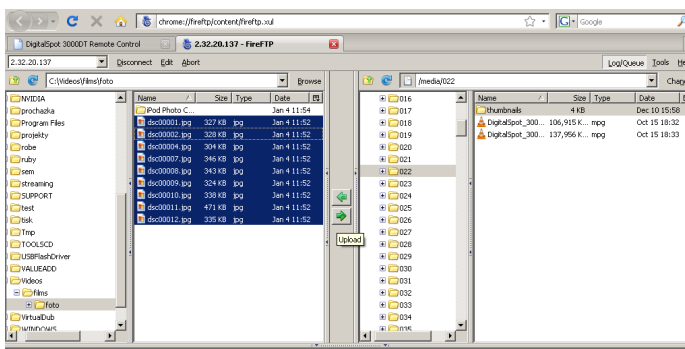

Now you can move files between PC and desired fixture.

3. Via USB stick

Next way, how to add or remove files from the media folders is by means of the USB stick - see "USB Data Synchronization" in chapter "Special functions".

21.2 Moving files between networked fixtures

The option "Contents Synchronization" in a "Remote control program" running on your PC offers easy control of file transfer between networked fixtures via WWW browser. (For detail description of the Remote configuration program see chapter "Remote control of the fixture via WWW browser" below).

A window of **Contents Synchronization**:

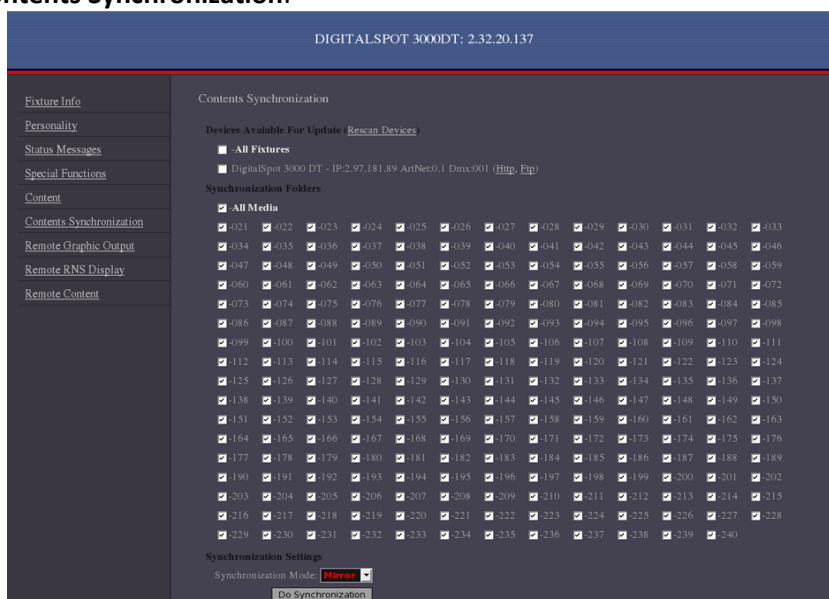

There is a list of available fixtures under **Device Available for Update**. If you connect another fixture to a network, use option "**Rescan Devices**" to refresh the list of fixtures.

A list of available folders with their check boxes is placed under **Synchronization Folders**.

Option "**Synchronization Mode**" gives you possibility to select how the files will be moved to target folder:

"**Mirror**"- a content of the target folder will be fully overwritten by a content of the source folder.

"**Add**"- files from the source folder are added to existing files in the target folder.

The last folder "**Update**" next to the gobo folder no. 240 serves for a synchronization of the "update" folders between the fixtures.

The last folder "**Update**" next to the gobo folder no. 240 serves for a synchronization of the "update" folders between the fixtures

To move files.

1. Select desired folders check boxes. If you want to select all folders, check All Media check box.
2. Select a target fixture (fixtures) in a list of available fixtures.
3. Select desired Synchronization Mode and click the "Do Synchronization" button to start the file transfer.

22. Remote control of the fixture via WWW browser

The DigitalSpot 3000 DT offers a remote control of the fixture and displaying useful information about the fixture including the gobo folders contents via WWW browser.

The fixtures has to be connected via an ethernet (with Art-Net communication protocol) to a network. The PC or light console has to be connected to the same network as the fixtures. Use only the IP addresses which have first number 2 like 2.X.X.X, e.g. 2.236.2.88.

To run a Remote control program type the IP address of the desired fixture to your WWW browser (e.g. http://2.236.2.88) and the input window of the Remote Control will appear.

Note: if you wish to have access to this utility under password, use the menu "HTTP Access" in "Special functions" to set a password.

The Remote Control screen offers these options:

DigitalSpot 3000 DT

Fixture Info - the window with information about current fixture address, disk space, software versions etc.

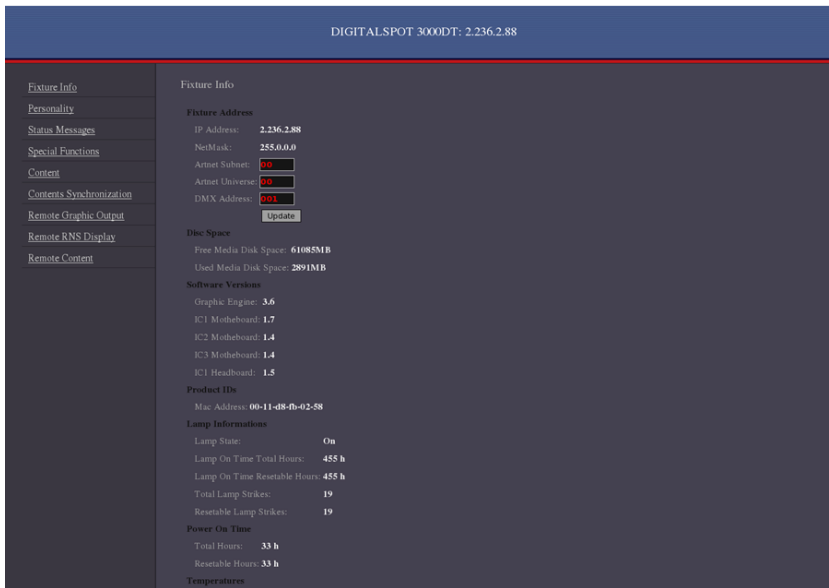

Personality - the window allows you to change the fixture settings like a pan/tilt reverse, feedback, speed, lamp status, DMX protocol selection etc.

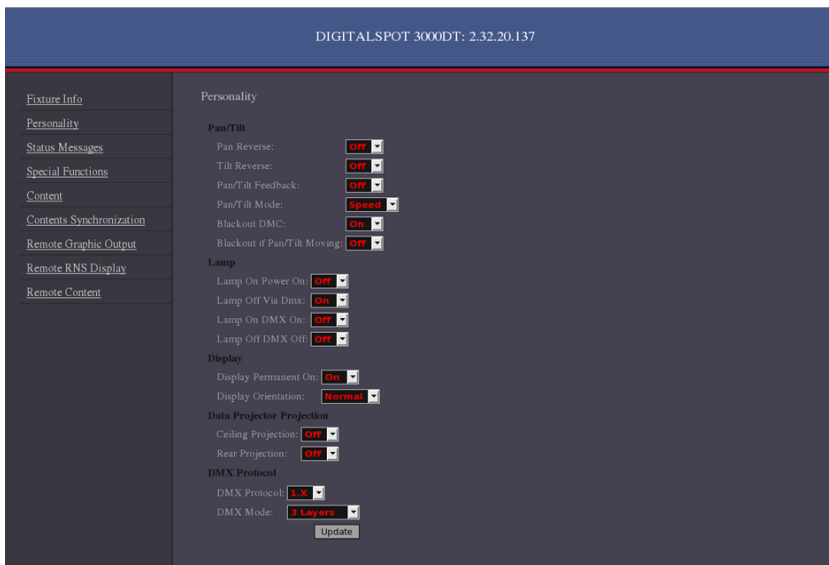

Status Messages -the window under this option displays error and status messages.

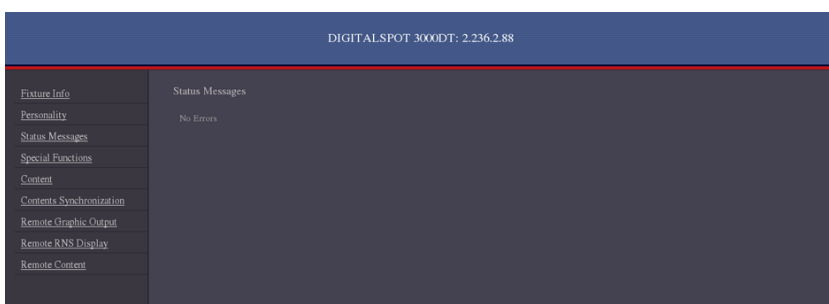

Special Functions - the window offers several items:

"**Thumbnails size**" - changing the size of the thumbnails. The change takes effect in the item "Content". If you change the thumbnail size, use the button "**Update**" below the size box.

"**Log File**" - enables to generate log file for service purposes.

"**System Reboot**" - starts reboot of the fixture



Content - by entering this window a complete overview of all gobo folders is offered, from which the folder to be view can be selected. Click a desired folder to display its content. Click a desired picture to zoom it in.

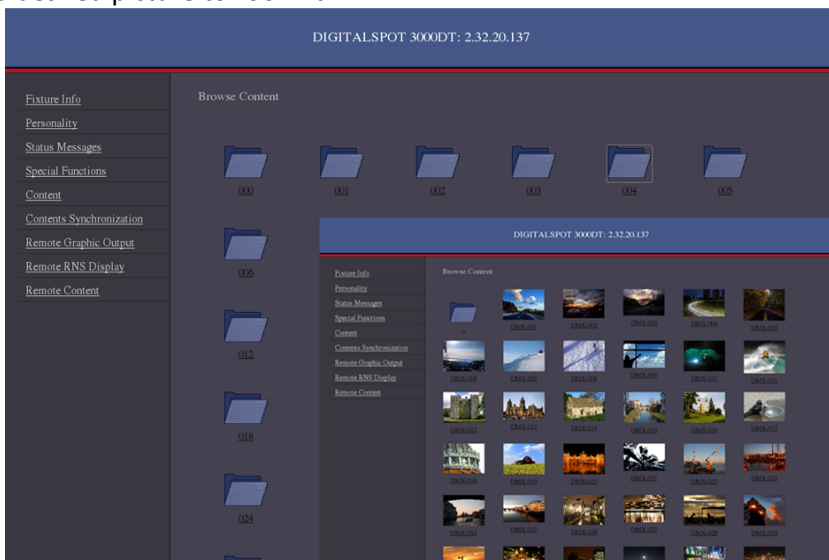

Contents Synchronization - the window allows you copy (addition) media content from a current fixture to another fixtures on an ethernet network.

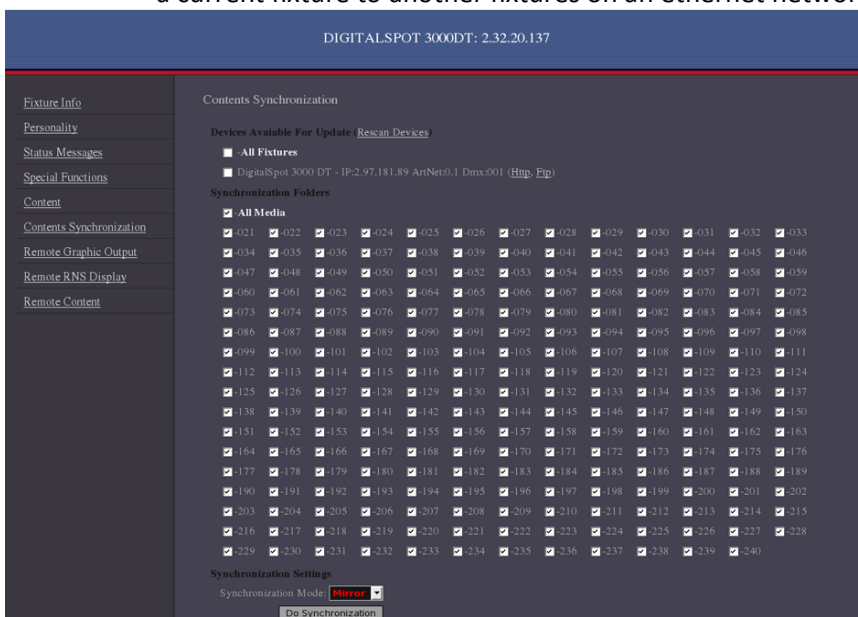

There is a list of available fixtures under **Device Available for Update**. If you connect another fixture to a network, use option "**Rescan Devices**" to refresh the list of fixtures.

A list of available folders with their check boxes is placed under **Synchronization Folders**.

Option "**Synchronization Mode**" gives you possibility to select the way how the files will be moved to target folder:

"**Mirror**"- a content of the target folder will be fully overwritten by a content of the source folder.

"**Add**"- files from the source folder are added to existing files in the target folder.

The last folder "**Update**" next to the gobo folder no. 240 serves for a synchronization of the "update" folders between the fixtures

To move files.

1. Select desired folders check boxes. If you want to select all folders, check "All Media" check box.
2. Select a target fixture (fixtures) in a list of available fixtures.
3. Select desired Synchronization mode and click the "Do Synchronization" button to start file transfer.

Remote Graphics Output - preview of the current projecting output.

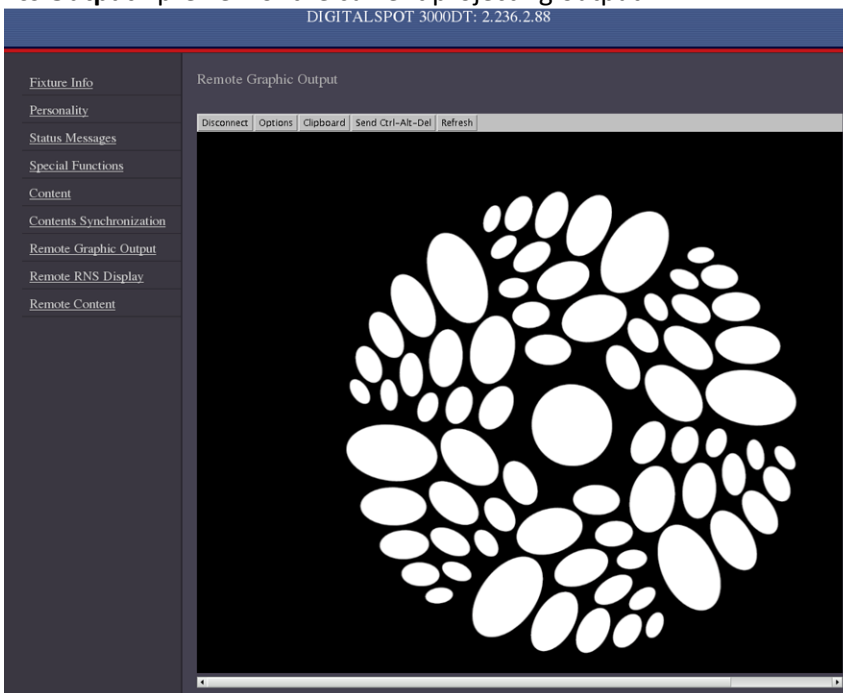

Remote RNS Display - the window "takes" the fixture's control panel. You can browse and adjust all items in this fixture menu by means of your keyboard. Use the Up/Down and Enter/Escape keys.

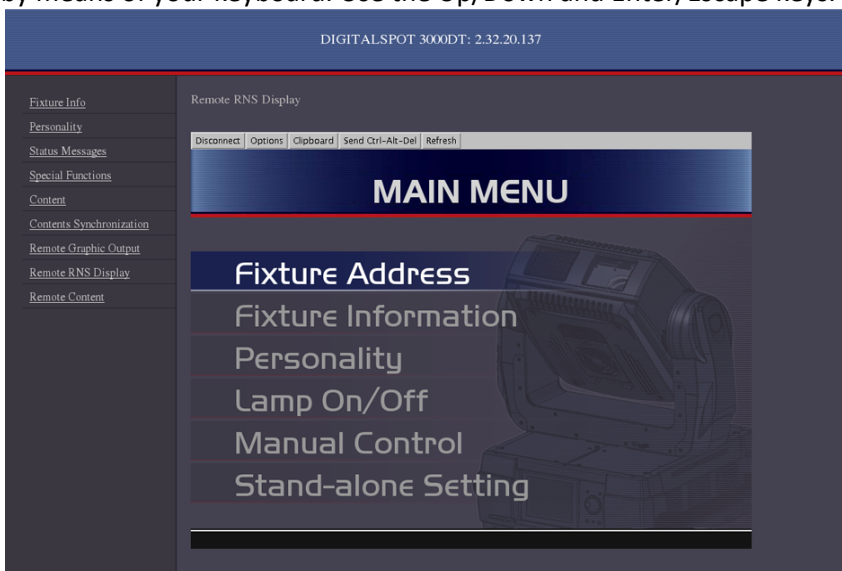

Remote Content - the window offers a table for definition of streaming sources. Type a streaming protocol, an IP address and a port number for the desired streaming source (e.g. laptop) to the first line in the following format: **http://2.x.x.x:port number** (for example **http://2.1.1.3:1234**)

and click the "Update" button on the right side of the line to save the streaming source address. This source is assigned to the DMX value of 1 on channel "Gobo selection". Up to 20 streaming sources is possible to define in this way.

All defined streaming sources are assigned to DMX values of the **Gobo selection** channel and can be used on each gobo layer.

Previous channel **Gobo folder selection** has to be set at DMX value of 252 in order to allow the use of streaming sources assigned to the **Gobo selection** channel. See chapter Streaming video.

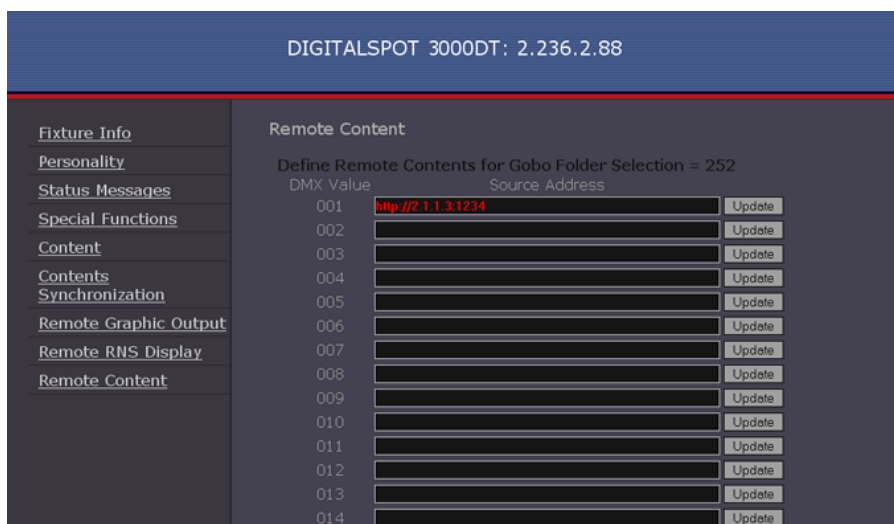

To end the Remote control program, close WWW browser (or use option "**Logout**" if you entered the program using the user name and password)

23. Picture merging

The picture merging system allows to create a panoramic projection controlled from a light DMX console. The resulting seamless image consists of the images of the individual projectors. It is possible to create an image field up to 64 segments (non-mirrored configuration).

You can display the original DigitalSpot 3000 DT gobos/videos or custom gobos/videos from user folders.

23.1 Picture merging control channels

Global effect 1

DMX values in a range of 1-7 enable the picture merging procedure. You can select from several predefined widths of the picture overlapping edges (from 0 to 35%). In many cases the projection screen is smaller than the total merged image of the projectors. This total image can be scaled either using Keystoning parameters or, (better) adjusting the width of blending areas.

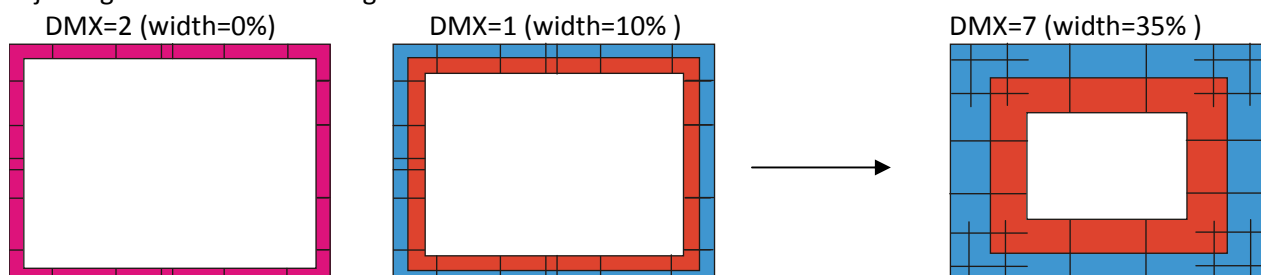

Global effect 1- Parameter 1

The DMX value from the range of 1- 235 allows selection of desired image field configuration according to the tables on the following pages.

DigitalSpot 3000 DT

Image field configuration

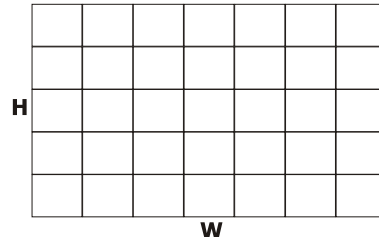

Non-mirrored configuration

DMX value	Image field Configuration W x H	Total number of fixtures	DMX value	Image field Configuration W x H	Total number of fixtures
1	2 x 1	2	56	4 x 8	32
2	1 x 2	2	57	8 x 5	40
2	2 x 2	4	58	5 x 8	40
4	3 x 1	3	59	8 x 6	48
5	1 x 3	3	60	6 x 8	48
6	3 x 2	6	61	8 x 7	56
7	2 x 3	6	62	7 x 8	56
8	3 x 3	9	63	8 x 8	64
9	4 x 1	4	64	9 x 1	9
10	1 x 4	4	65	1 x 9	9
11	4 x 2	8	66	9 x 2	18
12	2 x 4	8	67	2 x 9	18
13	4 x 3	12	68	9 x 3	27
14	3 x 4	12	69	3 x 9	27
15	4 x 4	16	70	9 x 4	36
16	5 x 1	5	71	4 x 9	36
17	1 x 5	5	72	9 x 5	45
18	5 x 2	10	73	5 x 9	45
19	2 x 5	10	74	9 x 6	54
20	5 x 3	15	75	6 x 9	54
21	3 x 5	15	76	9 x 7	63
22	5 x 4	20	77	7 x 9	63
23	4 x 5	20	78	10 x 1	10
24	5 x 5	25	79	1 x 10	10
25	6 x 1	6	80	10 x 2	20
26	1 x 6	6	81	2 x 10	20
27	6 x 2	12	82	10 x 3	30
28	2 x 6	12	83	3 x 10	30
29	6 x 3	18	84	10 x 4	40
30	3 x 6	18	85	4 x 10	40
31	6 x 4	24	86	10 x 5	50
32	4 x 6	24	87	5 x 10	50
33	6 x 5	30	88	10 x 6	60
34	5 x 6	30	89	6 x 10	60
35	6 x 6	36	90	11 x 1	11
36	7 x 1	7	91	1 x 11	11

DMX value	Image field Configuration W x H	Total number of fixtures	DMX value	Image field Configuration W x H	Total number of fixtures
38	7 x 2	14	93	2 x 11	22
39	2 x 7	14	94	11 x 3	33
40	7 x 3	21	95	3 x 11	33
41	3 x 7	21	96	11 x 4	44
42	7 x 4	28	97	4 x 11	44
43	4 x 7	28	98	11 x 5	55
44	7 x 5	35	99	5 x 11	55
45	5 x 7	35	100	12 x 1	12
46	7 x 6	42	101	1 x 12	12
47	6 x 7	42	102	12 x 2	24
48	7 x 7	49	103	2 x 12	24
49	8 x 1	8	104	12 x 3	36
50	1 x 8	8	105	3 x 12	36
51	8 x 2	16	106	12 x 4	48
52	2 x 8	16	107	4 x 12	48
53	8 x 3	24	108	12 x 5	60
54	3 x 8	24	109	5 x 12	60
55	8 x 4	32	-	-	-

Example

Image field configuration:

W x H = 2 x 2 = 4 projectors

DMX= 3

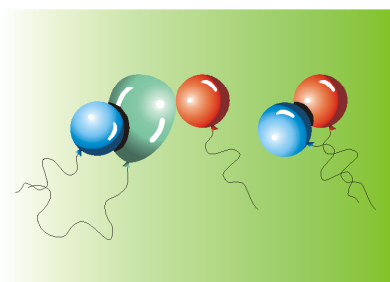
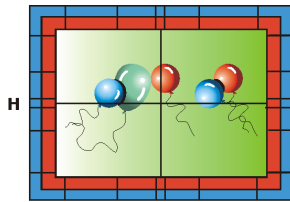

W x H = 4 x 4 = 16 projectors

DMX=15

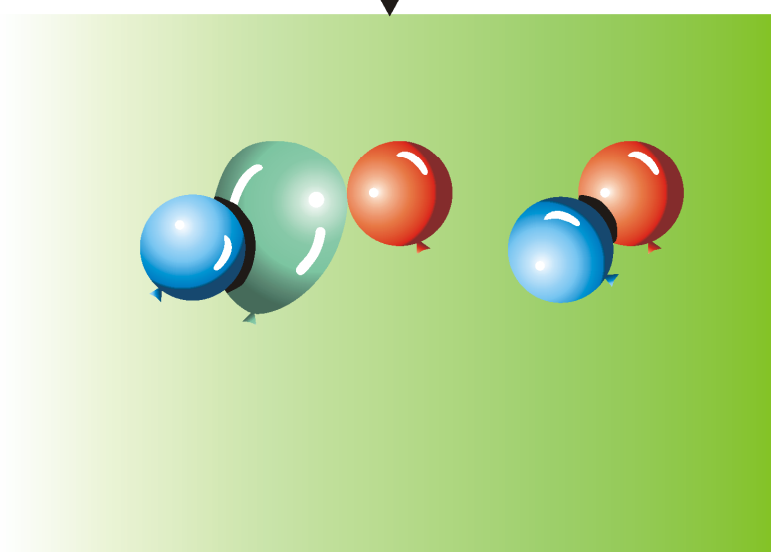
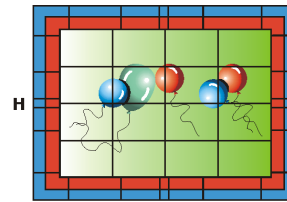

Horizontally mirrored configuration

DMX value	Image field configuration of base matrix W x H	Total number of fixtures in base matrix	DMX value	Image field configuration of base matrix W x H	Total number of fixtures in base matrix
128	2 x 1	2	146	10 x 2	20
129	4 x 1	4	147	4 x 5	20
130	2 x 2	4	148	10 x 3	30
131	4 x 2	8	149	6 x 5	30
132	6 x 1	6	150	10 x 4	40
133	2 x 3	6	151	8 x 5	40
134	6 x 2	12	152	10 x 5	50
135	4 x 3	12	153	12 x 1	12
136	6 x 3	18	154	2 x 6	12
137	8 x 1	8	155	12 x 2	24
138	2 x 4	8	156	4 x 6	24
139	8 x 2	16	157	12 x 3	36
140	4 x 4	16	158	6 x 6	36
141	8 x 3	24	159	12 x 4	48
142	6 x 4	24	160	8 x 6	48
143	8 x 4	32	161	12 x 5	60
144	10 x 1	10	162	10 x 6	60
145	2 x 5	10	163	12 x 6	72

Example

Image field configuration:

W x H = 2 x 2 = 4 projectors

DMX= 130

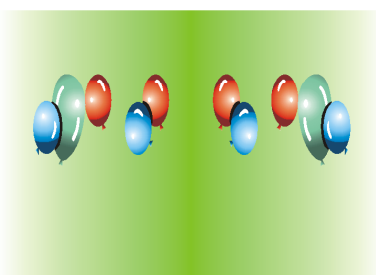
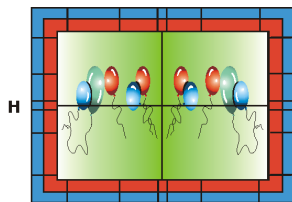

W x H = 4 x 4 = 16 projectors

DMX=140

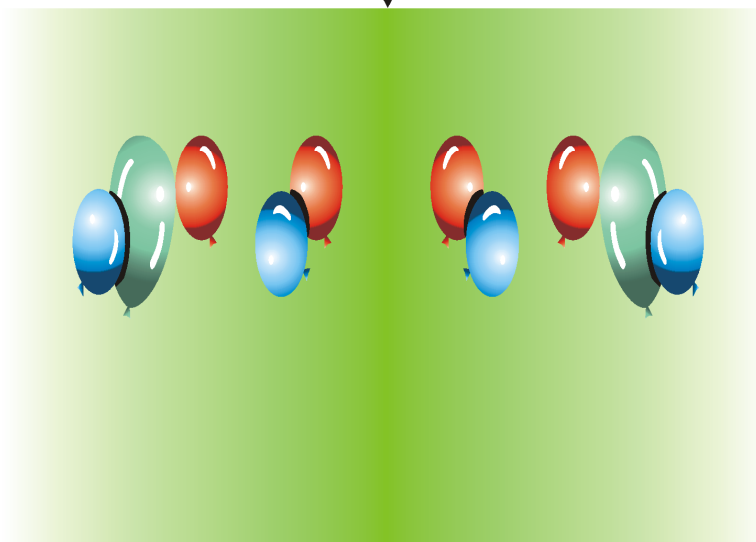
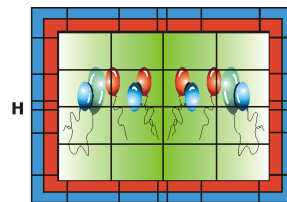

Vertically mirrored configuration

DMX value	Image field configuration of base matrix W x H	Total number of fixtures in base matrix	DMX value	Image field configuration of base matrix W x H	Total number of fixtures in base matrix
164	1 x 2	2	182	5 x 4	20
165	2 x 2	4	183	2 x 10	20
166	1 x 4	4	184	5 x 6	30
167	2 x 4	8	185	3 x 10	30
168	3 x 2	6	186	5 x 8	40
169	1 x 6	6	187	4 x 10	40
170	3 x 4	12	188	5 x 10	50
171	2 x 6	12	189	6 x 2	12
172	3 x 6	18	190	1 x 12	12
173	4 x 2	8	191	6 x 4	24
174	1 x 8	8	192	2 x 12	24
175	4 x 4	16	193	6 x 6	36
176	2 x 8	16	194	3 x 12	36
177	4 x 6	24	195	6 x 8	48
178	3 x 8	24	196	4 x 12	48
179	4 x 8	32	197	6 x 10	60
180	5 x 2	10	198	5 x 12	60
181	1 x 10	10	199	6 x 12	72

Example

Image field configuration:

W x H = 2 x 2 = 4 projectors

DMX= 165

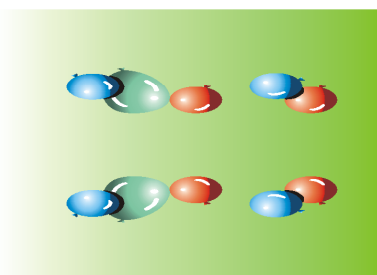
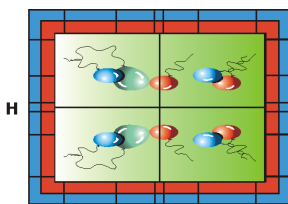

W x H = 4 x 4 = 16 projectors

DMX=175

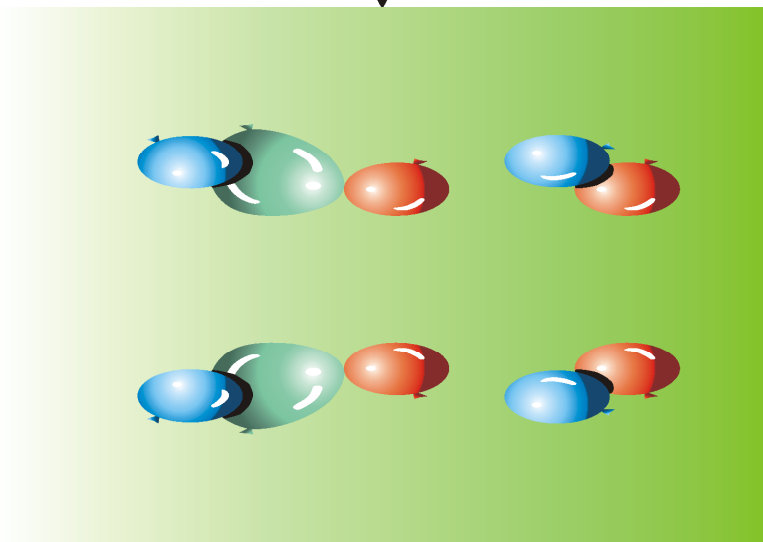
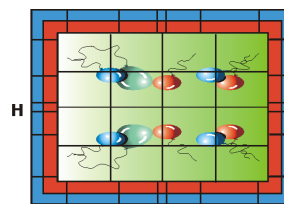

Vertically and horizontally mirrored configuration

DMX value	Image field configuration of base matrix W x H	Total number of fixtures in base matrix	DMX value	Image field configuration of base matrix W x H	Total number of fixtures in base matrix
200	2 x 2	4	218	10 x 4	40
201	4 x 2	8	219	4 x 10	40
202	2 x 4	8	220	10 x 6	60
203	4 x 4	16	221	6 x 10	60
204	6 x 2	12	222	10 x 8	80
205	2 x 6	12	223	8 x 10	80
206	6 x 4	24	224	10 x 10	100
207	4 x 6	24	225	12 x 2	24
208	6 x 6	36	226	2 x 12	24
209	8 x 2	16	227	12 x 4	48
210	2 x 8	16	228	4 x 12	48
211	8 x 4	32	229	12 x 6	72
212	4 x 8	32	230	6 x 12	72
213	8 x 6	48	231	12 x 8	96
214	6 x 8	48	232	8 x 12	96
215	8 x 8	64	233	12 x 10	120
216	10 x 2	20	234	10 x 12	120
217	2 x 10	20	235	12 x 12	144

Example

Image field configuration:

W x H = 2 x 2 = 4 projectors

DMX= 200

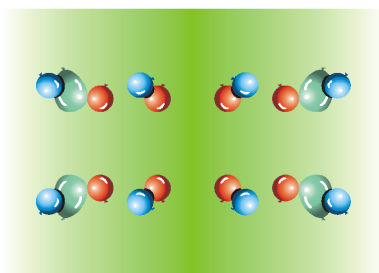
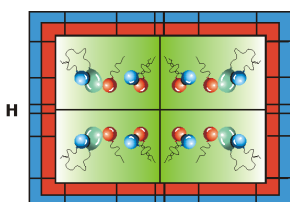

W x H = 4 x 4 = 16 projectors

DMX=203

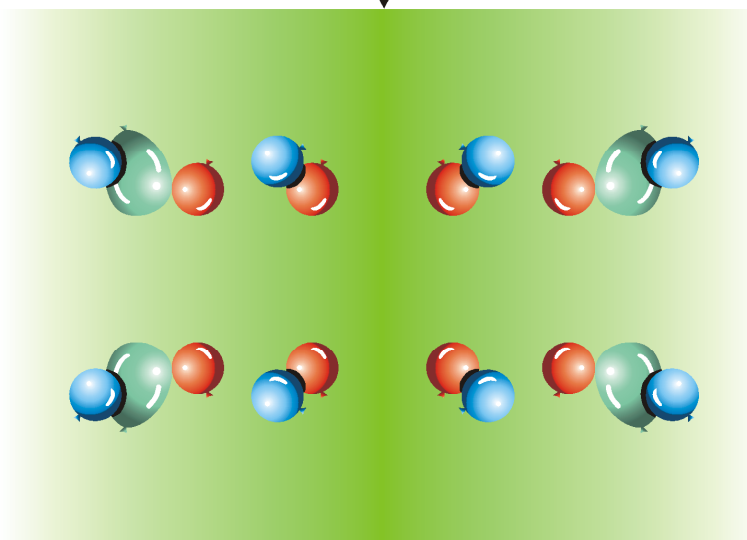
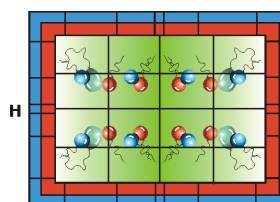

The mirrored image configurations bring 2 advantages:

1. Resolution of the source image and merged images on the wall is the same in comparison with non-mirrored configuration (if you use suitable mirrored configuration – see example 3 below).
2. By using the picture merging with mirrored configuration you can cover any size of projection area. The base matrix of fixtures can be repeated. The total number of used projectors is unlimited.

Examples: 4 DigitalSpots 7000DT are used in the picture merging.

Source picture

Aspect ratio: 4:3

Resolution: 1024 x 768

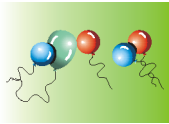

Images on the wall:

Example 1. Horizontally mirrored configuration 4 x 1 (DMX=129) set on all fixtures

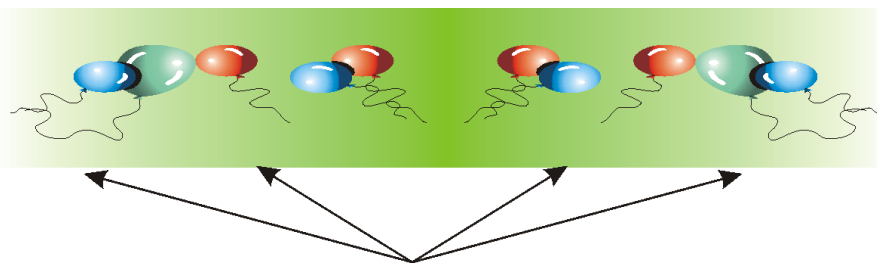

All projected images have a resolution of 1024 x 768, but the resolution of 1024 pixels is “made ” from 512 pixels as each fixture projects 1/2 of the source picture (this half has a source resolution 512 x 768).

Example 2. Horizontally mirrored configuration 2 x 1 (DMX=128) set on two pairs of fixtures

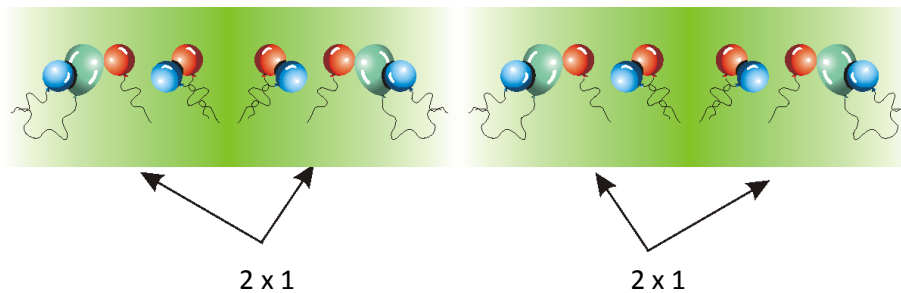

All projected images have a resolution of 1024 x 768 pixels and the total image does not have any distortion (horizontally or vertically). The base matrix 2 x 1 is twice repeated.

Example 3. Non- mirrored configuration 4 x 1 (DMX=9) set on all fixtures

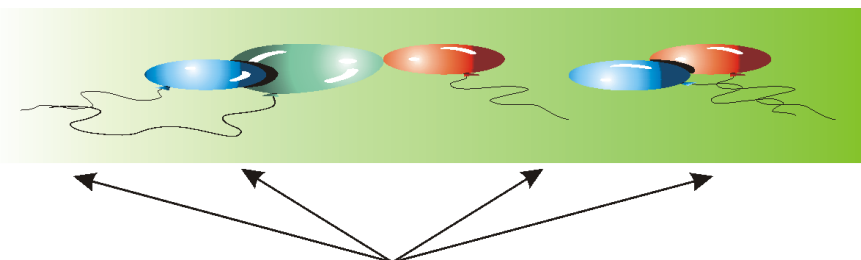

All projected images have resolution 1024 x 768, but the resolution of 1024 pixels is “made ” from 256 pixels as each fixture projects ¼ of the source picture (this quarter has a source resolution 256 x 768).

Global effect 1- Parameter 2

The DMX values from the range of 0-63 are used to step segment by segment throw the image grid. The DMX value of 0 corresponds to the upper left segment of the image grid. The stepping runs from the left to the right and down from top (see example for field 8x3 segments below).

DMX=0 Segment 1	Segment 2	Segment 3	Segment 4	Segment 5	Segment 6	Segment 7	Segment 8
DMX=8 Segment 9	Segment 10	Segment 11	Segment 12	Segment 13	Segment 14	Segment 15	Segment 16
DMX=16 Segment 17	Segment 18	Segment 19	Segment 20	Segment 21	Segment 22	Segment 23	Segment 24

Global effect 1- Parameter 3

This channel enables to transform displaying of the segment edges-sharp or blended edges. You can also display the blue and red auxiliary frame with the alignment marks for easier alignment of the adjacent segments:

Channel	Value	Function	Type of control
48	0-130	Global effect 1 - Parameter 3 Displays segment with blended edges (active keystone)	step
	131-141	Displays segment with sharp edges (active keystone)	step
	142-150	Displays segment with sharp edges	step
	151-160	Displays auxiliary pattern frame with sharp edges (active keystone)	step
	161-171	Displays auxiliary pattern frame, sharp edges	step
	172-255	Reserved	

To align segments use pan/tilt, zoom and keystone channels.

Segments before alignment:

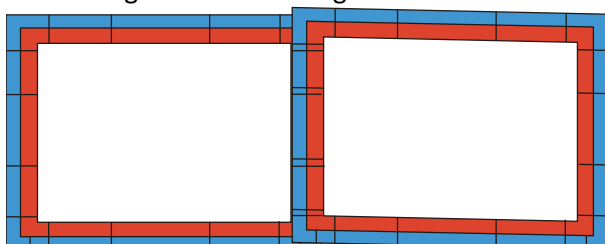

Segments after alignment:

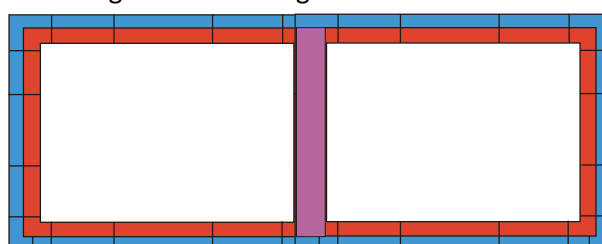

At adjacent edges there is the blue edge that overlaps the red one and respectively :

Note. DMX values of both channels **Global effect 1** and **Global effect 1- Parameter 1** have to be set at the same values on all fixtures used in the picture merging.

Global effect 2

A DMX value of 20 enables fine adjusting of the red, green and blue gamma curve at overlapping edges to achieve consistent colour(brightness) of these parts of image.

Note. After selecting desired image segment for the gamma correction (by means of the **Global effect 1 - Parameter 2**), set the channel **Global effect 1 - Parameter 3** to 0 in order to display blended edges of the picture segment.

Global effect 2- Parameter 1

The parameter adjust the red gamma value at respective image edge.

Global effect 2- Parameter 2

The parameter adjust the green gamma value at respective image adge.

Global effect 2- Parameter 3

The parameter adjust the blue gamma value at respective image adge.

23.2 Picture merging example

Here is an example of the image field 3x2.

1. All fixtures that are a part of the picture merging have to have a different fixture ID (**The fixture ID= the last number of its IP address**). The fixture's IP address consists of four numbers separated by the dot e.g. 002.168.002.010.
2. Select the same gobo/video on the six DigitalSpots 3000 DT.
3. On all fixtures you are configuring set a DMX value=1 at the channel **Global Effect 1**.
On all fixtures you are configuring set a DMX value=6 at the channel **Global Effect 1-Parameter 1**.
4. Set a DMX value at the channel **Global Effect 1- Parameter 3** between 151-160 to define a sharp edges of segments for a fine alignment.
5. On each individual fixture set a DMX value between 0-5 at **Global Effect 1 - Parameter 2** to select the segment that the fixture will project.
6. Use pan/tilt/zoom and keystone channels to align the projections of individual fixtures in such a way that there is some overlap between the separate portions of the image. This overlap is necessary for the picture merging adjustment.
7. Set a DMX value at **Global Effect 1- Parameter 3** between 131-141 to display the segment with sharp edges for fine adjustment by means the fine pan/tilt and keystones channels.

To execute the picture merging ,run the same gobo/video on all six fixtures and set the channels **Global Effect 1-Parameter 3** to a DMX value of 0-130.

Note: In order to assure a correct playback of videos sequences , all fixtures in the picture merging system should be synchronized to the one (master) fixture - see the chapter bellow.

24. Pre cutted content mode for Picture Merging

The mode is useful when you want to cover large projection area with full resolution for each projector or you don't want to be restricted with limits of matrix configuration.

The basic idea is that before projection you have to prepare the pre-cutted content (e.g. picture) and upload the single parts of the splitted source picture into individual fixtures.

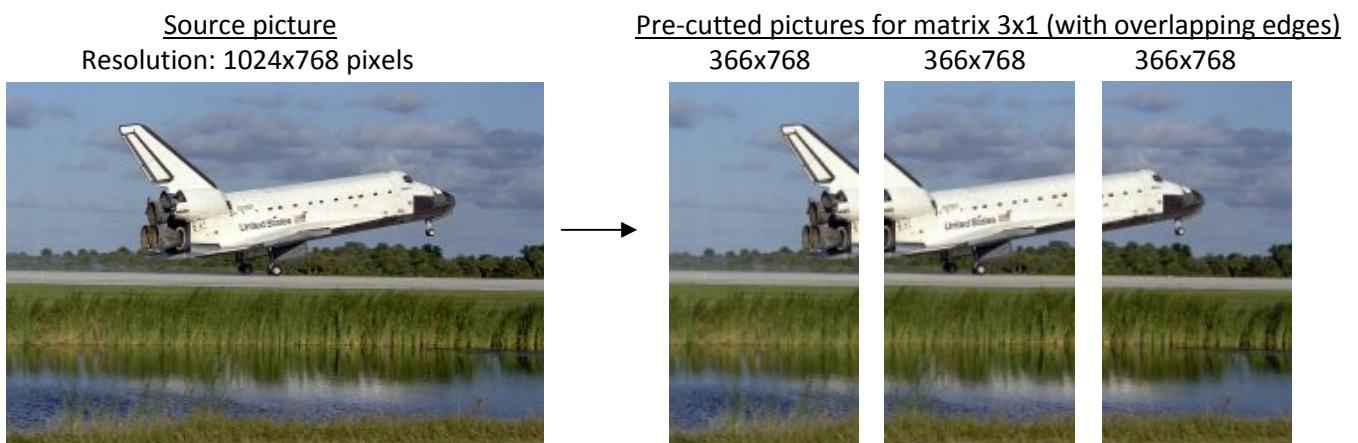

Single segments of the source picture must have the same size (pixels) which is given by:

$$L_{partX} = L_{totalX} / [x - (b/100) * (x-1)] \dots\dots\dots \text{Size of the single segment in X-axis}$$

$$L_{partY} = L_{totalY} / [y - (b/100) * (y-1)] \dots\dots\dots \text{Size of the single segment in Y-axis}$$

where

L_{partX} = size (pixels) of picture segment in X-axis

L_{partY} = size (pixels) of picture segment in Y-axis

L_{totalX} = total size (pixels) of the source picture in X-axis

L_{totalY} = total size (pixels) of the source picture in Y-axis

x = number of picture segments in X-axis

y = number of picture segments in Y-axis

b = size of overlapping edges in %

Positions at which single picture segments start in the source picture are given by:

$$L_{posX} = (N_x - 1) * L_{partX} * [1.0 - (b/100)] \dots\dots\dots \text{Position in X-axis}$$

$$L_{posY} = (N_y - 1) * L_{partY} * [1.0 - (b/100)] \dots\dots\dots \text{Position in Y-axis}$$

where

L_{posX} = position (pixels) at which segment starts in X-axis

L_{posY} = position (pixels) at which segment starts in Y-axis

N_x = order of the fixture image in X-axis (figured from the left side of the source picture)

N_y = order of the fixture image in Y-axis (figured from the bottom side of the source picture)

b = size of overlapping edges in %

The pre-cutted content mode has several advantages compared to the standard picture merging:

- unlimited size of the image field configuration matrix
- allows full resolution of every matrix element
- less loading of fixtures 'graphics engines

But the time for preparing pictures and calculation of the overlapping edges has to be taken into account.

There is an example of calculation of needed points in the source fixture for the image stated above.

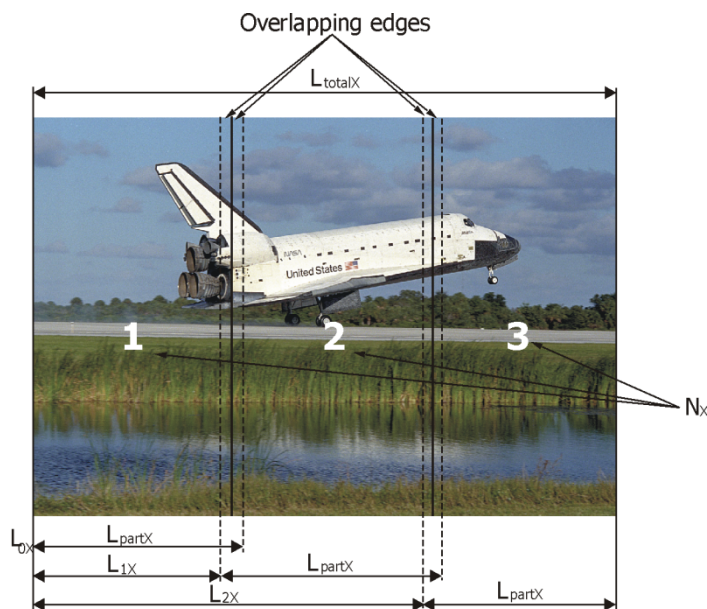

Size of segments in X-axis: $L_{partX} = L_{totalX} / [x - (b/100) * (x-1)]$

$$L_{partX} = 1024 / [3 - (10/100) * (3-1)] \text{ the size of overlapping edges was selected 10% } (b=10)$$

$$L_{partX} = 366 \text{ pixels}$$

Since the size of the segments in Y-axis is the same as at the source picture, each of the 3 fixtures will project picture with resolution of 366x768 pixels.

Note. On the other way round, if you need to calculate the resolution of the source picture to ensure that every fixture will use the resolution of 1024x768 pixels, use the formula:

$$L_{totalX} = L_{partX} * [x - (b/100) * (x-1)]$$

for this case: $L_{totalX} = 1024 * [3 - (10/100) * (3-1)]$ $L_{partX} = 1024 \text{ pixels}$
 $L_{totalX} = 2867 \text{ pixels}$

The source picture should have min. resolution of 2867x768 pixels.

Positions in X-axis at which single picture segments start:

$$L_{posX} = (N_x - 1) * L_{partX} * [1.0 - (b/100)]$$

For the segment 1: $L_{0X} = (1-1) * 366 * [1.0 - (10/100)] = 0 \text{ pixels}$ $N_x = 1$

For the segment 2: $L_{1X} = (2-1) * 366 * [1.0 - (10/100)] = 329 \text{ pixels}$ $N_x = 2$

For the segment 3: $L_{2X} = (3-1) * 366 * [1.0 - (10/100)] = 659 \text{ pixels}$ $N_x = 3$

Result: The first picture segment starts at point 0 pixels and has resolution of 366x768 pixels.

The second picture segment starts at point 329 pixels and has resolution of 366x768 pixels.

The third picture segment starts at point 659 pixels and has resolution of 366x768 pixels.

Using a suitable software you have to prepare these three pictures and copy them to the individual fixtures in order to use them in the picture merging procedure. On the channel **Global Effect 1** select a DMX value from the range of 11-17 DMX according as large overlapping edges you have calculated.

All other settings are the same as for standard picture merging operation.

Note. For correct video files synchronization you have to ensure that all cutted video segments must have the same times of video lasting.

25. Effect video synchronization

The synchronization option can be set separately for each gobo layer (channels **Synchronization to ID**). The fixture synchronization acts with the fixture ID which is defined as the last number of fixture's IP address. This fixture ID is shown on the fixture's display. The fixtures are synchronized to the one fixture - named a master fixture.

The fixtures may be controlled by the DMX but the fixture synchronization runs over ethernet network - it means that all fixtures that are to be synchronized have to be connected to the ethernet.

Each DMX value of the synchronizing channel responds to the fixture ID of a certain fixture.

You have to set the DMX value (ID) of the master fixture on all fixtures that are to be synchronized. If the DMX value = fixture ID, in this case the fixture is set as a master.

Example: 4 DigitalSpots 3000 DT which are synchronized through the gobo layer 1 to the fixture 3 :

	IP address	Fixture ID	Synchronization to ID (Channel 80)	
Fixture 1	002.168.002.010	10	DMX=20	
Fixture 2	002.168.002.015	15	DMX=20	
Fixture 3	002.168.002. 020	20	DMX= 20	Master fixture
Fixture 4	002.168.002.021	21	DMX=20	

Note: For a synchronous video projection on the layer 1, the channels **InFrame High, In Frame Low, Out Frame High, Out frame Low, Gobo control, Playback Speed** have to be set at the same values on all fixtures. The same rule proceeds for the gobo layer 2 and 3.

26. Projection onto angular, cylindric or spheric surfaces

If a projection on curved surface is required a correction of the shape distortions is necessary. The DigitalSpot 3000 DT supports projection onto angular screens, cylinders and spheres.

26.1 Curved surface support channels

Global effect 2

This channel enables you to select desired shape of the surface:

DMX Value	Surface	DMX Value	Surface	DMX Value	Surface
1	Vertical inside corner (opening towards fixture)	5	Vertical convex cylinder (opening towards fixture)	9	Orthographic sphere mapping Note: parameter 1 range: 0-127 - convex surface adjustment 128 - no adjustment (default) 129-255 - concave surface adjustment
2	Vertical outside corner (opening away from fixture)	6	Vertical concave cylinder (opening away from fixture)	10	Rectangle to circle (sphere) Note: Keystone parametres have a different meaning
3	Horizontal inside corner (opening towards fixture)	7	Horizontal convex cylinder (opening towards fixture)	11	Square to circle (sphere) Note: Keystone parametres have a different meaning
4	Horizontal outside corner (opening away from fixture)	8	Horizontal concave cylinder (opening away from fixture)		

To simplify a correction process, there is a gobo with a net pattern (DMX value = 2) in a factory folder No. 20 (DMX value= 20) on a *Gobo folder selection* channel each gobo layer.

Global effect 2- parameter 1

This parameter enables to adjust the total length of the image edge. A value of 0 means no adjustment, a value of 255 means maximum correction.

Note. If a corner projection is selected on a **Global effect 1** (values of 1-4), the red guiding line will appear in the image (the gobo with the net pattern has to be projected).

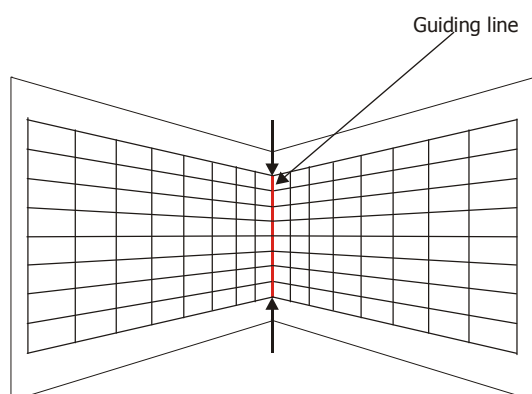

Global effect 2- parameter 2

This parameter enables to adjust the horizontal length of the edge. A DMX Value of 128 = no adjustment, values below 128 move the edge to the left, values above 128 move the edge to the right.

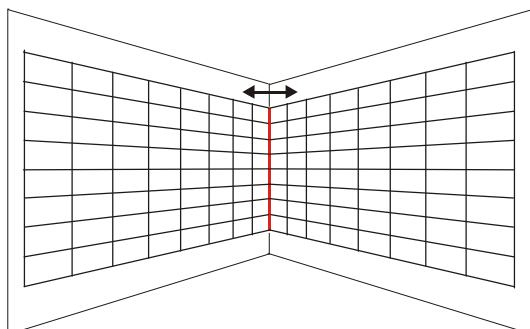

Global effect 2- parameter 3

This parameter enables to adjust the vertical length of the edge. A DMX Value of 128 = no adjustment, values below 128 move the edge downwards, values above 128 move the edge upwards.

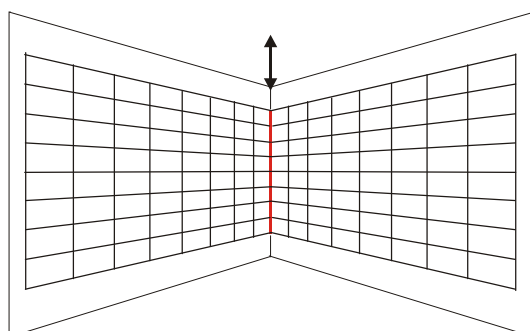

These global effect 2 parameters 1-3 have to be used in combination with the KeyStone and KeyStone X-ratio (Y-ratio) parameters to adjust desired shape of image.

Corner projection

Example:

1. Project the gobo with a net pattern on the wall (the channel **Gobo Folder selection** ,is set at a value of 20 ,the channel **Gobo selection** at a value of 2).
2. Set the channel **Global Effect 2** to a Horizontal inside corner mapping (DMX value=3)
3. Use the channel **Global Effect 2 -Parameter 1** to adjust the length of the image edge.
4. Use the channels **Global Effect 2 -Parameter 2**, and **Global Effect 2 -Parameter 3** and Keystone channels to correct image on the wall.
5. Use the **KeyStone Y -ratio** channel for the final correction of the image.

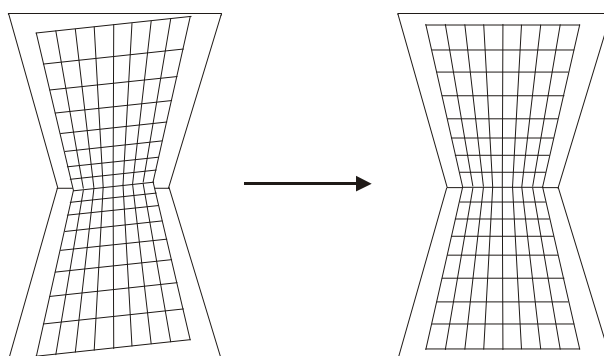

Note:

If a projection of rectangle (square) on a circle (sphere) is selected on the channel **Global Effect 2** (DMX value of 10 or 11), the meaning of the Keystone parameters in a DMX chart will be changed as follows:

Channel	DMX value	Function	Type of control
18	0 -127 128 129-255	Image moving in an X-direction Moving the image from left to center Center Moving the image from center to right	proportional step proportional
19	0 -127 128 129-255	Image moving in a Y-direction Moving the image from bottom to center Center Moving the image from center to top	proportional step proportional
20	0 - 255	Squeezing in an X-direction Continual squeezing	proportional
21	0 - 255	Squeezing in a Y-direction Continual squeezing	proportional
22	0 - 255	Squeezing in a diagonal direction (top right-bottom left) Continual squeezing	proportional
23	0 - 255	Squeezing in a diagonal direction (bottom left-top right) Continual squeezing	proportional
24	0-255	Zoom Continual zooming	proportional
25	0-255	Indexing Anticlockwise indexing	proportional

26.2 Rectangle onto circle (sphere) mapping with picture merging

This effect in contrast to the effects stated above allows not only a projection onto a circle (sphere) but in addition enables a picture merging onto a circle (sphere) surface.

This effect can be activated on the the **Global Effect 2 Selection** channel at a DMX Value of 12. The **Parameter 1** of the effect changes the sphere diameter. The **Parameter 2** and **Parameter 3** correct distortion in X-axis and Y-axis due to the different projection angles of the fixtures.

There are examples for the image field configuration 2x2:

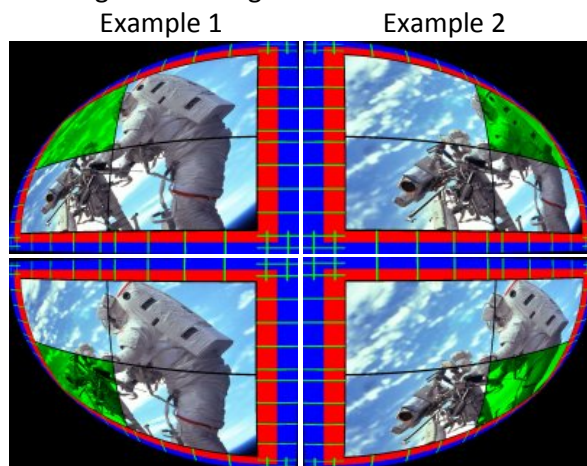

Example 3

Example 4

27. Video processing on gobo layers from a streaming video server

A streaming video is a video that is continuously sent by one device (e.g. PC) and received by another device (DigitalSpot 3000 DT) over an ethernet network.

The Streaming video software stated on the pictures below is available at <http://www.videolan.org/vlc/>.

Download VLC media player from this web page and install it on your streaming source (PC, notebook..).

Here are important installation points how to prepare a video processing on gobo layers from a remote streaming video source in the fixture.

Streaming source (here is an example for PC running Windows XP)

1. Download the VLC media player to the PC (Windows self-extracting package 0.8.6f),
2. Set PC network card for Art-Net network:
 - Menu path: "Start" --> "Control Panel" --> "Network Connection" --> "Connection"

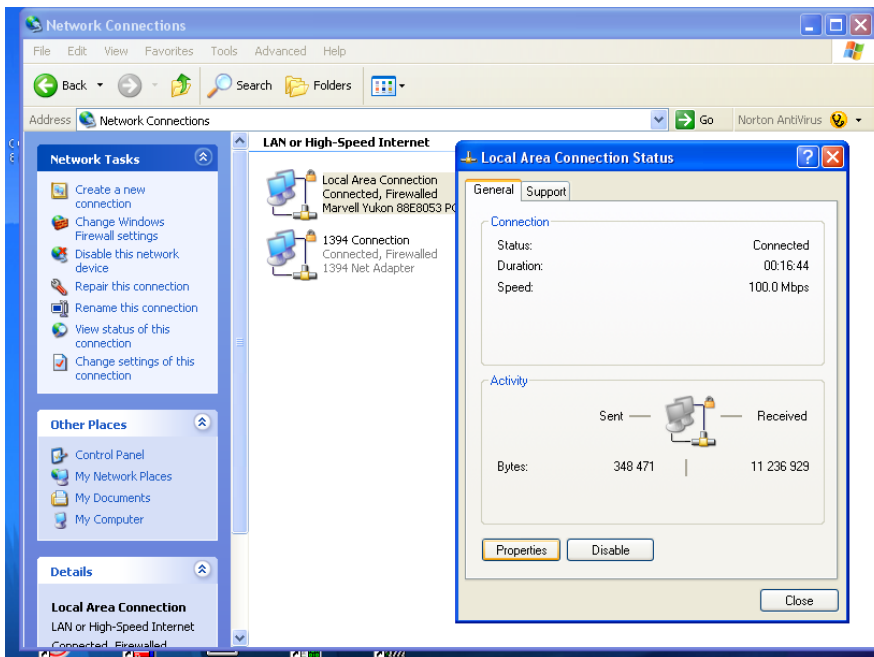

- Click on the "Properties" button and the following window will open.

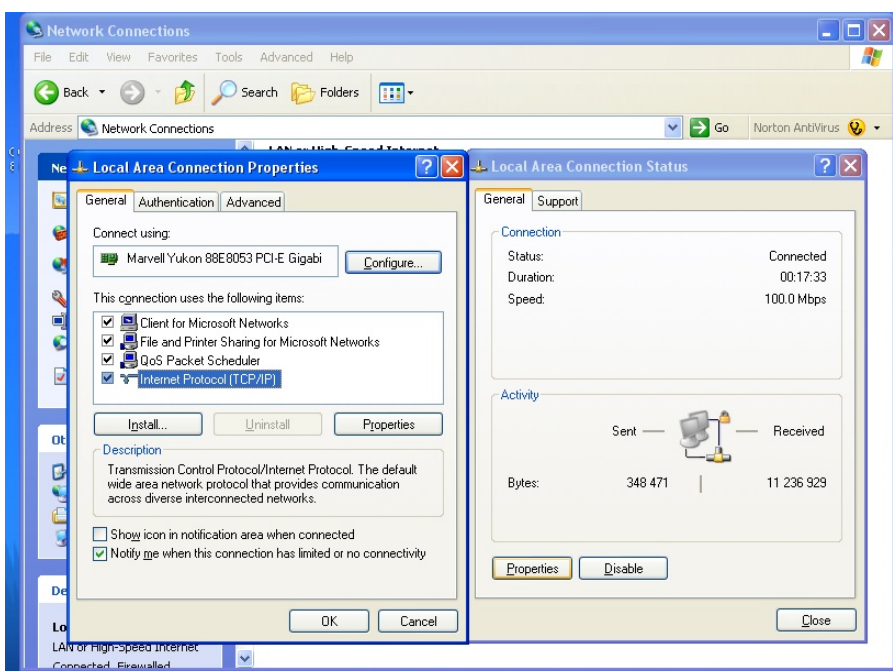

- Click on the item "Internet Protocol (TCP/IP)" and the Internet Protocol Properties window will open. Set IP address to something like 2.X.X.X with an IP mask of 255.0.0.0

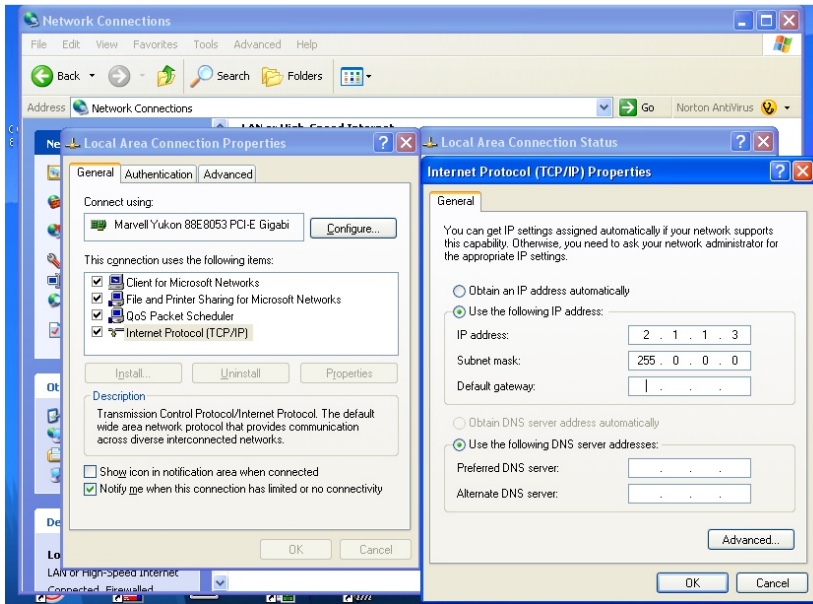

3. Install a VLC media player-

- click on a VLC media player self-extracting package located on the hard disk and follow the on-screen instructions. After installing it, run this VLC media player. In a horizontal menu "File" click on "Open" and the following window will open.

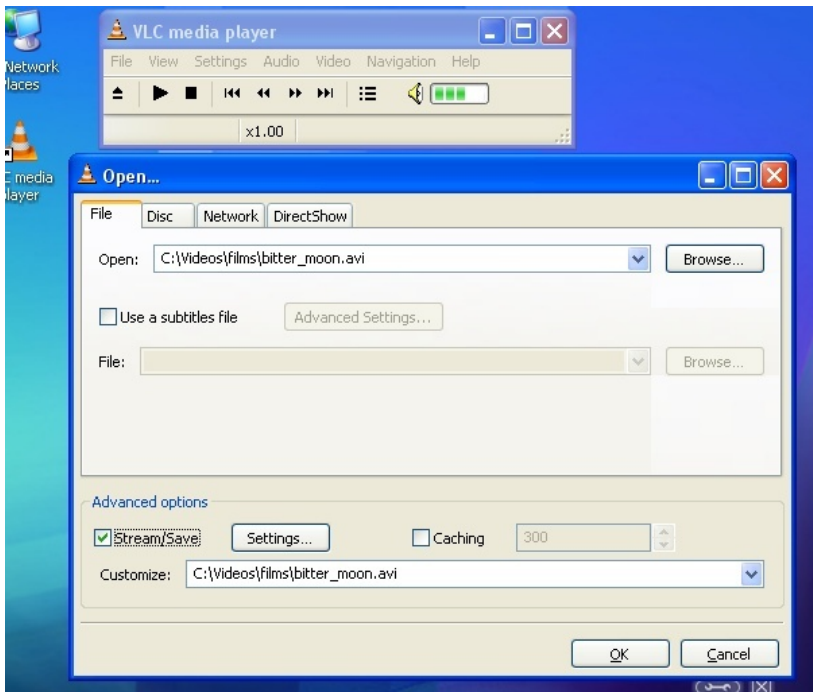

- Type the name of video file in the "Open" field, check the "Stream/Save" option and click the "Settings" button. The "Stream output" window will open:

DigitalSpot 3000 DT

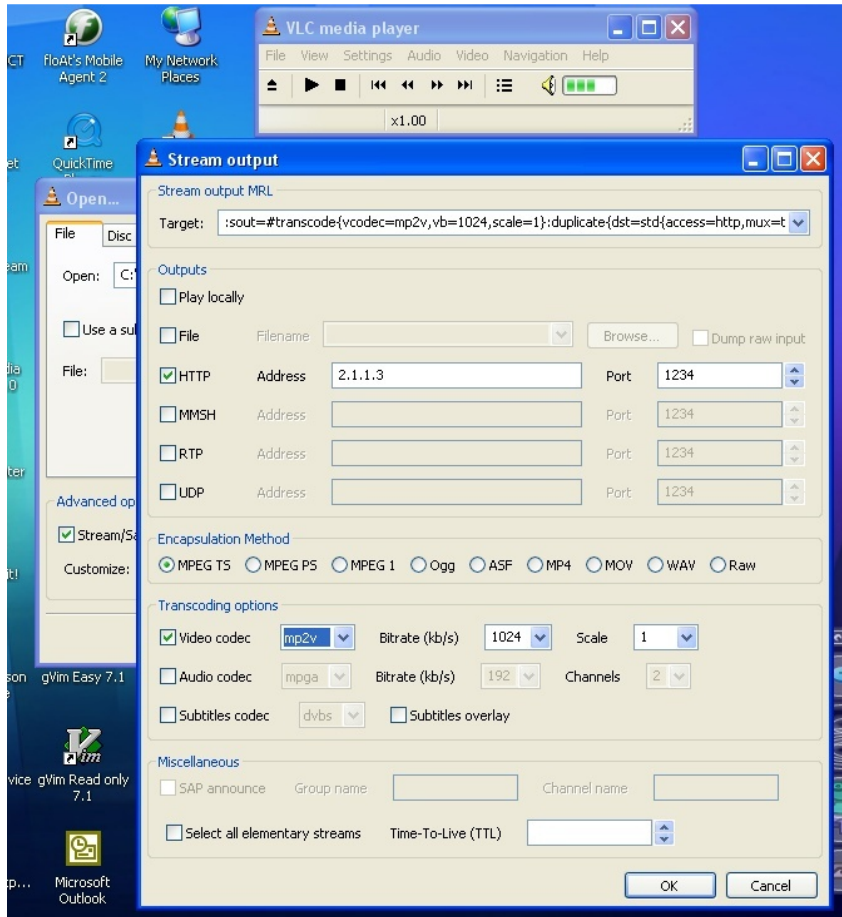

Check the "HTTP" option in a Outputs column, type an IP address of the PC in the "Address" field and a figure port in the "port" field.

Note: If you want to run more videos on this PC, you have to run the VLC media player for each video and every media player has to have a different figure of the port but the IP address will be the same.

Select the MPGTS or MPEGPS option in the "Encapsulation method" row. Check the "Video codec" option and select mp2v. In the field "Bitrate kb/s" set value of 1024 or higher.

The Bitrate is the number of kbits that are conveyed or processed per second. The higher is the number, the higher is the quality of the projected image. For streaming of desktop we recommend the bitrate of 8192.

Click the "OK" button and confirm the "Open" window.

The VLC media player is now ready for playing up the video sequences.



PC Desktop streaming

The desktop streaming enables you to send your presentation directly to the DigitalSpot 3000 DT via an ethernet network. You do not need extra cables for connecting video inputs of the DigitalSpot 3000 DT with your PC.

DigitalSpot 3000 DT

A different setting of VLC media player for streaming of the PC desktop is required. Type the following line in the "Customize" field of the Open window:

screen:// screen-fps=10 :screen-caching=100

Space

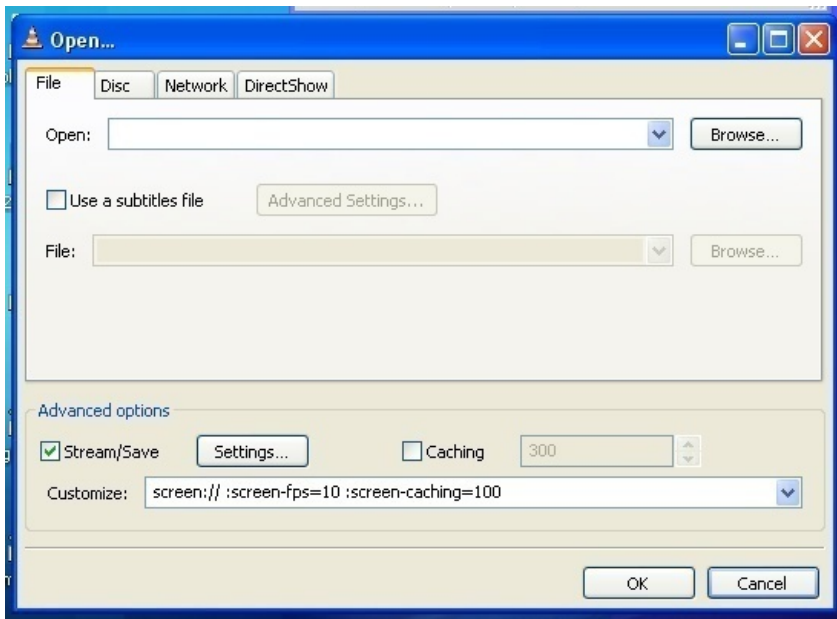

The Stream output window has the same setting like for video streaming except the field "Bitrate (kb/s)" which should be set at the value of 8192.

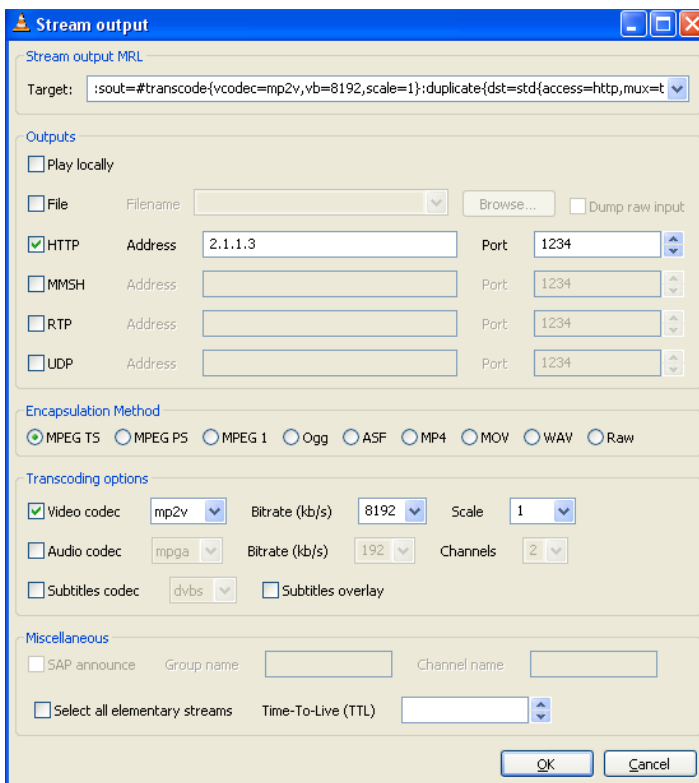

Important: The *Playback speed* channel at corresponding gobo layer should be set at a DMX value of 150-200.

Control PC (light console)

Type the IP address of the DigitalSpot 3000 DT which is to project data from a remote streaming video source in your WWW browser to run the Remote Control program.

Select the option "Remote Content" and the following window will open:

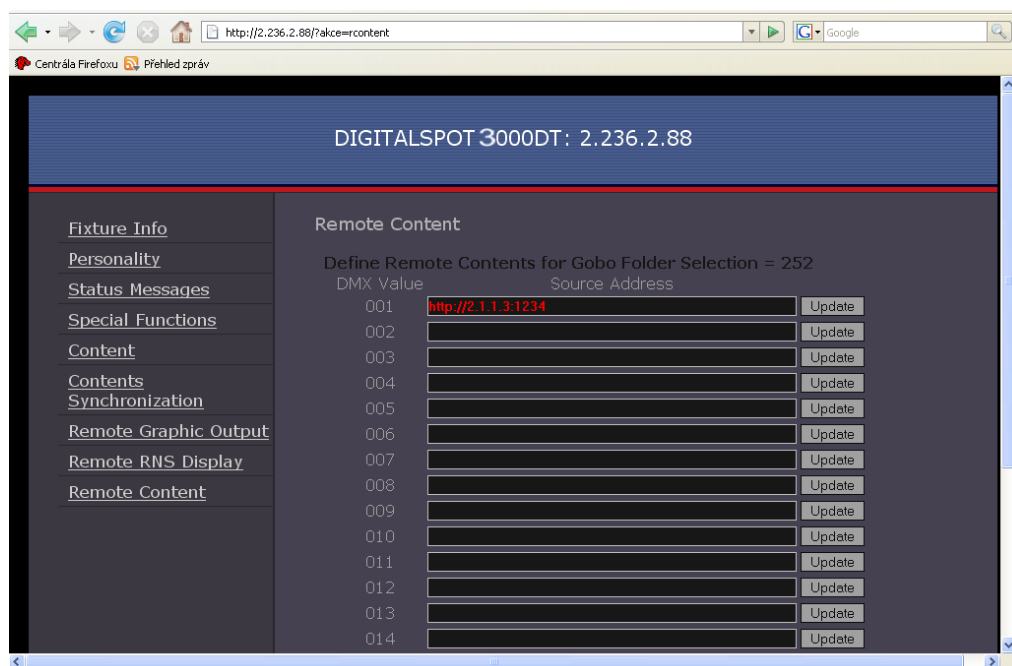

Type in the "source Address" field the IP address and the port number of the streaming source (in our case it is a PC) in this format: http://2.x.x.x:port number e.g. http://2.1.1.3:1234 and save it by clicking the "Update" button. This way defined streaming source is assigned to a DMX value of 1 at the channel **Gobo selection**.

You can define another videos from the same streaming source - the IP addresses will be the same for all videos only the port numbers have to be different.

After specifying all streaming sources close the "Remote Content" window.

To run a video processing on the fixture

On The DigitalSpot 3000 DT which is to project video data from a streaming video source, set the channel **Gobo folder selection** at value of 252 and on the following channel "Gobo selection" set a DMX value which responds to the streaming video source defined in the "Remote Content" window. The streaming video processing starts running with a delay of cca 10 seconds.

Example for gobo/video layer 1:

Channel	DMX Value	Function	Type of control
54	0-20	<u>Gobo Folder selection</u>	
	21-240	Factory folders	step
	241-250	User folders	step
	251	Reserved	
	252	Live input (grab. card)-see channel 55	step
	253-255	Streaming from remote source Reserved	step
55	0	<u>Gobo selection</u>	step
	1 - 255	White	step
		255 Gobos/videos (one by one)	
		<i>If Live input (251 DMX) is selected on channel 54:</i>	
	0	White screen	step
1-20	Video composite input-PAL system	step	
:	:	:	:

DigitalSpot 3000 DT

Fixture linkage:

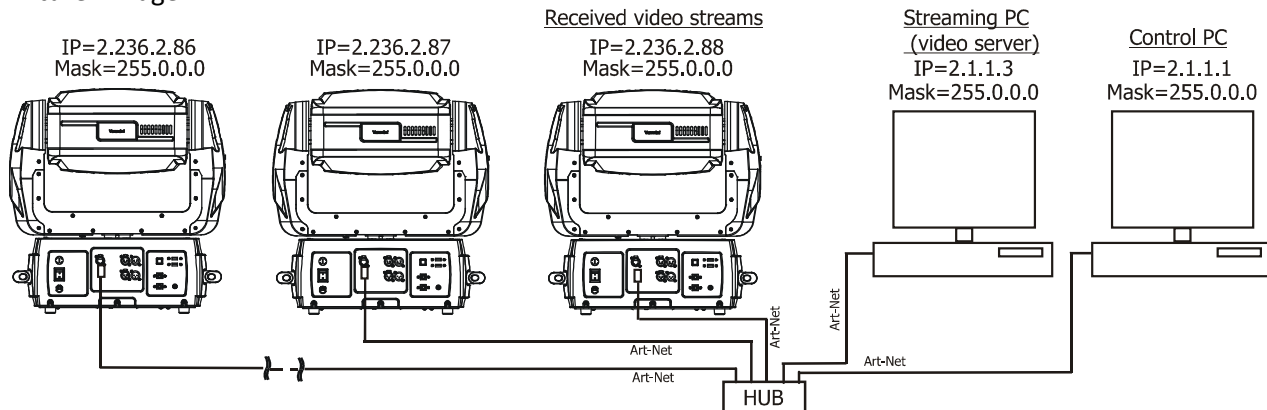

28. RDM

This fixture is ready for RDM operation. RDM (Remote Device Management) is a bi-directional communications protocol for use in DMX512 control systems, it is the new open standard for DMX512 device configuration and status monitoring.

The RDM protocol allows data packets to be inserted into a DMX512 data stream without adversely affecting existing non-RDM equipment. By using a special „Start Code,“ and by complying with the timing specifications for DMX512, the RDM protocol allows a console or dedicated RDM controller to send commands to and receive messages from specific moving lights.

RDM allows explicit commands to be sent to a device and responses to be received from it.

The ROBE DreamBox allows to utilize all DigitalSpot 3000 DT RDM functionality. Please read the DreamBox user manual for detail description of RDM possibilities.

29. Technical specifications

Electrical specifications:

Auto-switching power supply

Input voltage range: 100-120V/ 200-240V AC, 50/ 60 Hz

Max. Power Consumption @ 230V: 420W (450VA), I=1.9A)

power factor: 0.93

Projector Specifications:

Model MP624

Light output: 3000 ANSI lumens

Lamp: 200W

Rated lamp life: 3000/4000 hours (normal/eco mode)

Aspect ratio: 4:3

Resolution: XGA (1,024x768)

Image size 24" to 300"

Throw ratio: 1.8 - 2.0: 1

Contrast ratio: 2,500:1 (full on/full off)

Display technology: DLP by Texas Instruments

Display colours: Full 16.7 million colour palette

Model MP622

Light output: 2,700 ANSI lumens

Lamp: 200W

Rated lamp life: 4,000 hours (economic mode)

Aspect ratio: 4:3

Resolution: XGA (1,024x768)

Image size 24" to 300"

Throw ratio: 1.82 - 2.0: 1

Contrast ratio: 2,000:1 (full on/full off)

Display technology: DLP by Texas Instruments

Display colours: Full 16.7 million colour palette

Hardware

Motherboard: MSI G31M-F

Processor: Intel Core 2 Duo E6750, 2.66 GHz, 1333 MHz FSB

Memory: 1GB RAM

Graphics card: nVidia 8600 GT

Video capture card AverMedia: DVD EZMaker

Hard disk: Seagate Momentus 120 GB

Gigabit Ethernet

Operation system

Linux OS

Graphic engine

3 Digital Gobo Layers for Image and Video Control

Layer Media Control Modes (Copy, Add, Subtract, Multi, Minimum and Maximum)

Banner Effects creating action scripts for Images or Videos

Graphic engine supports a combined total of more than 60,000 original and user-created videos/gobos usable on all gobo layers

Digital Iris effect + 160 Masking effects

Full Key-Stone correction

Digital strobe effect

CMY Image and Video Colour Mixing and CTC (Colour Temperature Correction)

DigitalSpot 3000 DT

2 Gobo (Image) Effect Engines per Layer

2 independent effect channels on each gobo layer with more than one hundred of effects

Huge amount of Default Images/Videos

Import of User Images or Videos

Supported Image Formats: BMP, JPG, TGA, PNG, GIF, PCX, PNM, XPM and LBM

Max. image resolution is limited to 4096x4096 pixel (since data projector works in 1024x768 pixel, therefore it is recommended to convert the image to 1024x768 pixel if the picture merging is not used)

Supported Video Formats: MPEG1, MPEG2

Effect video synchronization

Preview of projecting output through interface

Picture Merging effect in the field up to 64 segments (non-mirrored configuration)

Projection on to cylindrical/spherical surfaces and angular screens

Video processing on all gobo layers from remote streaming video server

Control

5" TFT LCD display & Robe navigation system

Web access for total control of fixture (user library management)

Media Content Synchronization in web interface

136 control channels max.

RDM support

Pan/Tilt

Pan movement range: 530°

Tilt movement range: 280°

16 bit movement resolution

Controllable speed of Pan/Tilt movement

Automatic Pan/Tilt position correction

Built-in Pan/Tilt macro effects

Focus

Motorized

Shutter

Motorized

LedWash module

Light source: 48 Luxeon Rebel LEDs (12 red, 12 green, 12 blue, 12 white)

Optical system: 25° beam angle

RGB colour mixing

Shutter and adjustable strobe sequences

Full range dimming

Connections

video inputs: Data projector: 1 x S-Video (Mini Din 4 pin)

1 x Composite video (RCA)

Graphic Engine: 1xS-Video (Mini Din 4 pin)

1x Composite video (RCA)

DMX data in/out: Locking 3-pin and 5-pin XLR

ArtNet: RJ 45 (Neutrik Ethercon)

AC power input: 1.3 m power cord without plug

2 x USB 2.0 (series A)

Environmental Specifications

Operating temperature range: 0° - 40°C

DigitalSpot 3000 DT

Maximum housing temperature: 60°C

Rigging

Mounting points: 2 pairs of ¼-turn locks
2 x Omega bracket with ¼-turn quick locks
Safety chain/cord attachment point

Dimensions (mm)

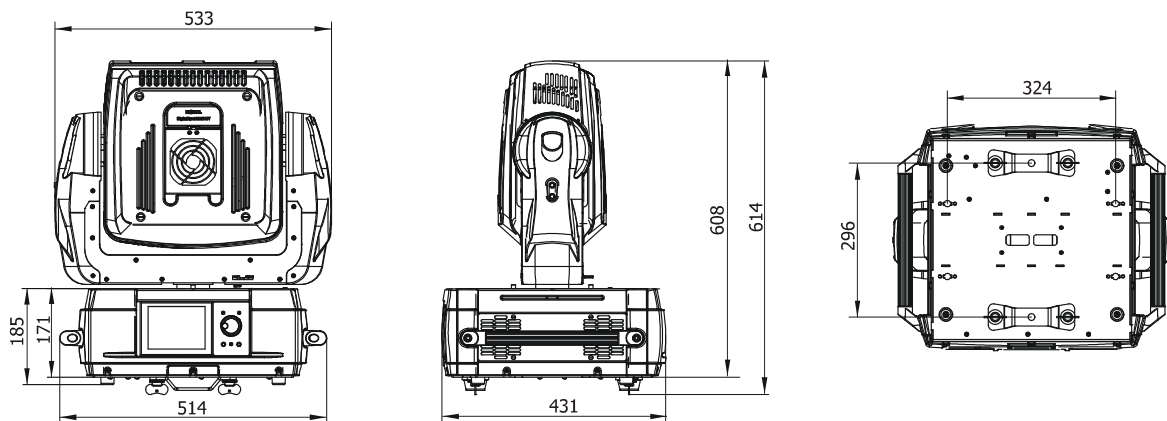

Weight

28 kg

Accessories

Omega holder (No.99010420).....2 pieces
USB 2.0 flash drive with a System recovery utility.

30. Error and information messages

The warning icon (triangle) on the bottom-right side of the fixture's screen indicates some error or information message which appears on the screen by pressing the [ESC] button.

Pan Error

The message will appear after the reset of the fixture if the yoke's magnetic-indexing circuit malfunctions (sensor failed or magnet is missing) or the stepping motor is defective or its driving IC3 on the PCB in the fixture base. The yoke is not located in the default position after the reset of the fixture.

Tilt Error

The message will appear after the reset of the fixture if the head's magnetic-indexing circuit malfunctions (sensor failed or magnet is missing) or the stepping motor is defective or its driving IC3 on the PCB in the fixture base. The head is not located in the default position after the reset of the fixture.

Focus Error

The message will appear after the reset of the fixture if the focus module's magnetic-indexing circuit malfunctions (sensor failed or magnet is missing) or the stepping motor is defective or its driving IC1 on the PCB in the fixture head. The focus is not located in the default position after the reset of the fixture.

Shutter Error

The message will appear after the reset of the fixture if the shutter's magnetic-indexing circuit malfunctions (sensor failed or magnet is missing) or the stepping motor is defective or its driving IC1 on the PCB in the fixture head. The shutter lamella is not located in the default position after the reset of the fixture.

Power Down Mode

The fixture is in "power down mode"- this mode omits fixture reset after switching it on, and reduces the power of motors. "Power down mode" is useful in special cases e. g. if the fixture is in a flight case and you want to set its DMX address without taking it out from the case. To enter „Power down mode“, press and hold [ENTER] button and at the same time switch on the power switch.

Now you can set DMX address and behaviour of the fixture by using menu "Personality". If you want to go to a "normal operation mode", run a total fixture reset.

Please Clean Air Filters

The message warns you that the time interval adjusted in the menu item Time To Cleanup Filters in the Service menu has expired and you should clean fixture's air filters.

Please Update HW Processors in Menu "Special Functions"

Run update of the hardware functions - see chapter "Special functions".

LED Temperature Sensor Open

The message informs you that there is not communication between the sensor measuring the temperature of the LED module and the control PCB. This connection is broken.

LED Temperature Sensor Short

The message informs you that there is not communication between the sensor measuring the temperature of the LED module and the control PCB. This connection is in short circuit.

31. Maintenance

31.1 Replacing the lamp

Turn the power off and disconnect the fixture from the mains. If the lamp is hot, avoid burns by waiting for approximately 45 minutes until the lamp has cooled.

1. Remove the top cover (1) of the fixture head by loosening the four quarter-turn fasteners (2).

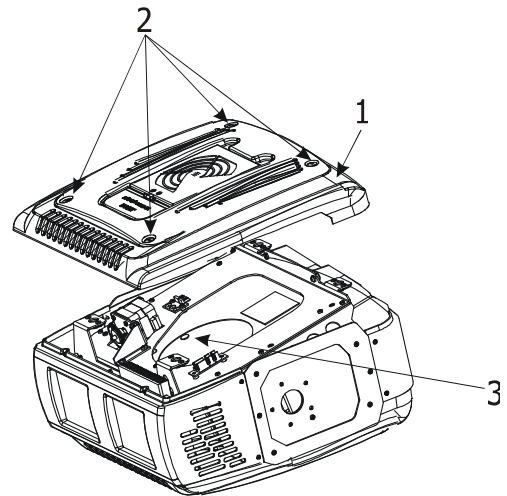

2. Remove the lamp cover (4) by loosening screw (3). Do not turn the power on with the lamp cover removed.

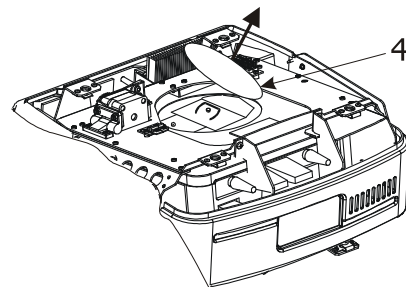

3. Loosen the screw (5) that secures the lamp. Lift the handle (6) so that it stands up. Use the handle to slowly pull the lamp out of the projector.

Note: Pulling it too quickly may cause the lamp to break and scatter broken glass in the projector. Do not insert your hands into the projector after the lamp is removed. If you touch the optical components inside, it could cause colour unevenness and distortion of the projected images.

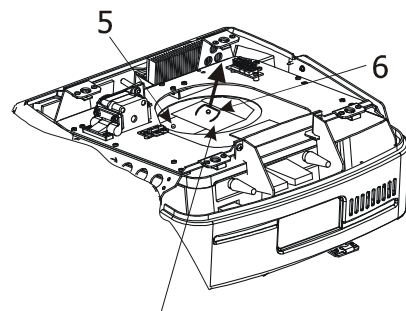

4. As shown in details, lower the new lamp first into the connector on the projector and align the two holes on the projector. Tighten the screw (5) that secures the lamp. Loose screw may cause a bad connection, which could result in malfunction. Do not over tighten the screw.

DETAILS

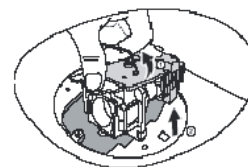

5. Place the lamp cover (4) back and tighten the screw (3). Cover the fixture head.

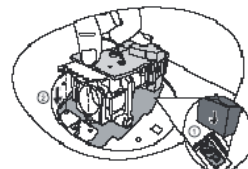

6. Switch on the the fixture and reset the counter "Resetable Hours" in the "Lamp on Time" menu.

31.2 Replacing the projector

If you need to remove the data projector, turn the power off and disconnect the DigitalSpot 3000 DT from the mains. If the projector lamp is on, wait 25 minutes until the projector has cooled.

1. Remove both covers (1) of the fixture head (2) by loosening the four quarter-turn fasteners (3) on each cover.

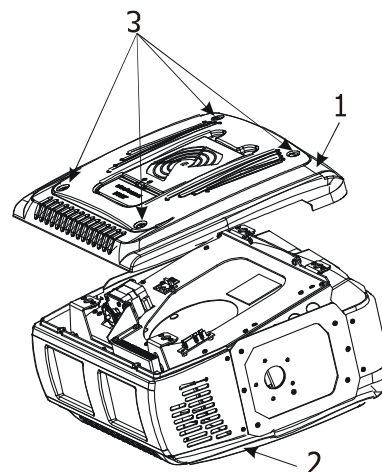

2. Remove the rear cover (4) by loosening four side screws (5) and four screws (6) on the rear side. Disconnect all power and data cables (7) from rear panel of the projector.

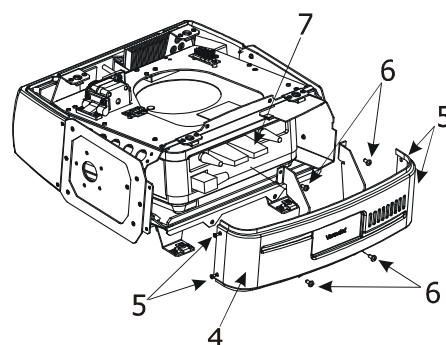

3. Bow the head and loosen the four screws (9) on the bottom side of the head that fastening the projector chassis (10) to the fixture head.

Warning:

The projector can fall out from the head if all fixing screws (9) are missing from chassis.

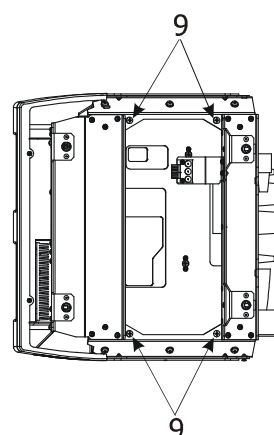

4. Unscrew two fastening screws (8) which securing the focus driving motor and lift off this motor.

Carefully take the projector (11) with chassis (10) out from the head.

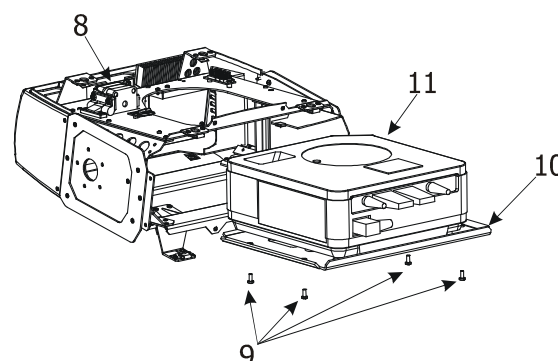

31.3 Replacing the air filters

Important! Check the air filters periodically and clean before they become clogged!

Clean the air filters with a vacuum cleaner or you can wash them and put back dry.

Replacing air filters in the fixture head.

- 1) Disconnect the fixture from power.
- 2) Raise up a filter cover (1) (fixed by two magnets) on the head cover
- 3) Pull the air filter (2) out.
- 4) Clean or replace the air filter.
- 5) Snap the filter cover back to the head cover.
- 6) Reset item "Time To Cleanup Filters" in the "Service menu".

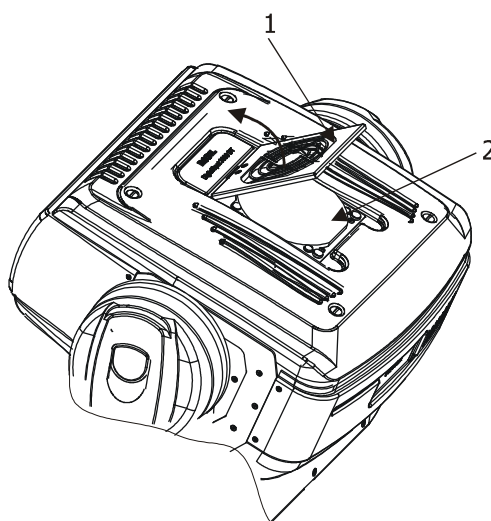

Replacing the air filter in the fixture base.

- 1) Disconnect the fixture from power.
- 2) Remove a side cover (2) by loosening the 4 quarter-turn fasteners (1).
- 3) Pull the air filter (3) out.
- 4) Clean or replace the air filter .
- 5) Put the side cover back.
- 6) Reset item "Time To Cleanup Filters" in the "Service menu".

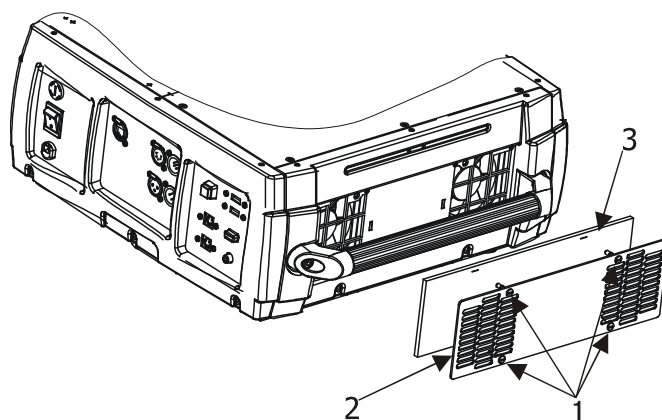

31.4 Replacing the fuse

Only replace the fuse by a fuse of same type and rating.

Before replacing the fuse, turn the power off and unplug the mains lead.

Procedure:

- 1) Unscrew the fuse holder on the rear panel of the base with a fitting screwdriver from the housing (anti - clockwise).
- 2) Remove the old fuse from the fuse holder.
- 3) Install the new fuse in the fuse holder.
- 4) Replace the fuse holder in the housing and fix it.

31.5 System restore

You can perform a system restore on the DigitalSpot 3000 DT with your System Restore USB flash drive.

Warning.
***The system restore replaces all fixture settings and the Media folder content.
This action return the device to a factory state.***

For a system restore, you will need:

- the USB flash drive with a System restore utility (part of Digital 3000 DT delivery)
- the USB keyboard

Use the following steps to perform a system restore:

1. Plug the USB flash drive with System restore utility and the USB keyboard into two external USB ports on the DigitalSpot 3000 DT.
2. Power on the DigitalSpot 3000 DT. When the fixture boots, press Delete key on the keyboard to enter the fixture's computer SETUP and set the boot from USB drive (Path: "Advanced Bios Features" --- >"1st boot device"---> "[USB]).
3. Save this setting and exit SETUP. The fixture continues booting, wait until you see a full-screen menu titled:

Image Manager for ROBE Digital Products
Options:
Write "rescue" for enter to Main Menu

4. Type the word **rescue** on the keyboard and the following screen will appear:

Options:
Restore From Backup
Restart

5. Select option "Restore From Backup" to start recovery process This process will take cca 5 minutes.
6. Select option "Restart" to restart the fixture. After a few minutes you may remove all your external USB devices. Now the fixture is in a factory state and you should perform update (if required) of graphical software, HW processors and media content to the current state.

31.6 Cleaning

Turn the power off and disconnect the fixture from the mains. before starting cleaning procedure.

It is absolutely essential that the fixture is kept clean and that dust, dirt and smoke-fluid residues must not build up on or within the fixture. Otherwise, the fixture's light-output will be significantly reduced. Regular cleaning will not only ensure the maximum light-output, but will also allow the fixture to function reliably throughout its life.

A soft lint-free cloth moistened with any good glass cleaning fluid is recommended, under no circumstances should alcohol or solvents be used!

DANGER !
***Disconnect from the mains before starting any
cleaning and maintenance work***

The front covering glasses will require weekly cleaning as smoke-fluid tends to building up residues, reducing the light output very quickly.

The cooling fans should be cleaned monthly.

The interior of the fixture should be cleaned at least annually using a vacuum-cleaner or an air-jet.

More complicated maintenance and service operations are only to be carried out by authorized dealers.

Cleaning a projection lens of the projector.

Apply a non-abrasive camera lens cleaner to a soft, dry cleaning cloth. Avoid using an excessive amount of cleaner. Abrasive cleaners, solvents or other harsh chemicals might scratch a surface. Lightly wipe a cleaning cloth over projection lens.

DigitalSpot 3000 DT - DMX protocol v. 1.4; June 26, 2009			
DMX Channel	DMX Value	Function	Type of control
1		Pan	
	0-255	Pan movement by 530°	proportional
2		Pan Fine	
	0-255	Fine control of pan movement	proportional
3		Tilt	
	0-255	Tilt movement by 280°	proportional
4		Tilt Fine	
	0-255	Fine control of tilt movement	proportional
5		Pan/Tilt speed,Pan/Tilt time	
	0	Max.speed (tracking mode)	step
		<i>P./T. speed-set Speed Mode in menu: Pan/Tilt Mode</i>	
	1-255	Speed from max. to min.(vector mode)	step
		<i>P./T. time-set Time Mode in menu: Pan/Tilt Mode</i>	
	1-255	Time from 0.1s to 25.5s	step
6		Pan/Tilt macro selection	
	0-9	Disabled pan/tilt macro	step
	10-31	Reserved	
	32-63	Figure of circle (from small to large)	proportional
	64-95	Figure of horizontal eight (from small to large)	proportional
	96-127	Figure of vertical eight (from small to large)	proportional
	128-159	Figure of reactangle (from small to large)	proportional
	160-191	Figure of triangle (from small to large)	proportional
	192-223	Figure of star (from small to large)	proportional
	224-255	Figure of cross (from small to large)	proportional
7		Pan/Tilt macro speed	
	0	No macro	step
	1-127	Macro generation from fast to slow (forwards)	proportional
	128-129	No macro	step
	130-255	Macro generation from slow to fast (backwards)	proportional
8		Power/Special functions	
	0-39	Reserved	
		To activate following function, the LED Shutter (channel 16) must be at range 240-250 DMX.	
	40-44	Internal Hardware (PC) reset	step
	45-49	Reserved	
		To activate following functions,hold DMX value 3 sec. and digital iris must be closed at least 3 sec. (channel 33 must be at 255 DMX).Corresponding menu items are temporarily overridden	
	50-59	Pan/Tilt speed mode	step
	60-69	Pan/Tilt time mode	step
	70-79	Blackout while pan/tilt moving	step
	80-89	Disabled blackout while pan/tilt moving	step
	90-94	Ceiling projection On	step
	95-99	Ceiling projection Off	step
	100-104	Rear projection On	step
	105-109	Rear projection Off	step
	110-114	DMX In	step
115-119	Artnet In	step	
	120-129	Reserved	

Appendix - DMX protocol

DMX Channel	DMX Value	Function	Type of control
8		To activate following function,hold DMX value 3 seconds	
	130-139	Lamp On	step
	140-149	Pan/Tilt reset	step
	150-179	Reserved	
	180-189	Focus reset	step
	190-199	Reserved	step
	200-209	Total reset	step
	210-215	Graphic engine reset/software update executing	step
	216-229	Reserved	
	230-239	Lamp Off	step
	240-249	Lamp Off,Fixture Off (<i>hold DMX value 5 seconds</i>)	step
	250-255	Reserved	
9		Video input selection	
	0-63	Internal graphic engine	step
	64-127	External Composite to projector	step
	128-191	External S-video to projector	step
	192-255	Reserved	
10		Focus	
	0-255	Continuous adjustment from far to near (128-default)	proportional
11		Fine Focus	
	0-255	Fine adjustment (128-default)	proportional
12		Red LEDs	
	0-255	Red LEDs saturation control 0 --> 100 %	proportional
13		Green LEDs	
	0-255	Green LEDs saturation control 0 --> 100 %	proportional
14		Blue LEDs	
	0-255	Blue LEDs saturation control 0 --> 100 %	proportional
15		White LEDs	
	0-255	White LEDs saturation control 0 --> 100 %	proportional
16		LED shutter and strobe	
	0-31	Shutter closed	step
	32-63	Shutter open	step
	64-95	Strobe effect, slow --> fast	proportional
	96-127	Shutter open	step
	128-143	Opening pulses in sequences, slow --> fast	proportional
	144-159	Closing pulses in sequences, fast --> slow	proportional
	160-191	Shutter open	step
	192-223	Random strobe-effects, slow --> fast	proportional
	224-255	Shutter open	step
17		LED Dimmer	
	0-255	Led module dimmer intensity 0 --> 100 %	proportional
18		KeyStone Top Left X	
	0-255	Move top left corner X value to center (0-default)	proportional
19		KeyStone Top Left Y	
	0-255	Move top left corner Y value to center (0-default)	proportional
20		KeyStone Top Right X	
	0-255	Move top right corner X value to center (0-default)	proportional
21		KeyStone Top Right Y	

Appendix - DMX protocol

DMX Channel	DMX Value	Function	Type of control
	0-255	Move top right corner Y value to center (0-default)	proportional
22		KeyStoneBottom Right X	
	0-255	Move bottom right corner X value to center (0-default)	proportional
23		KeyStone Bottom Right Y	
	0-255	Move bottom right corner Y value to center (0-default)	proportional
24		KeyStone Bottom Left X	
	0-255	Move bottom left corner X value to center (0-default)	proportional
25		KeyStone Bottom Left Y	
	0-255	Move bottom left corner Y value to center (0-default)	proportional
26		KeyStone X-ratio	
	0-127	Ratio control from left to center	proportional
	128	Center (default)	step
	129-255	Ratio control from center to right	proportional
27		KeyStone Y-ratio	
	0-127	Ratio control from bottom to center	proportional
	128	Center (default)	step
	129-255	Ratio control from center to top	proportional
Common effects for all gobo layers			
28		Cyan	
	0-255	Cyan continuously (0-white,255-full cyan)	proportional
29		Magenta	
	0-255	Magenta continuously (0-white,255-full magenta)	proportional
30		Yellow	
	0-255	Yellow continuously (0-white,255-full yellow)	proportional
31		CTF	
	0	Without CTF	step
	1	14000 K	step
	2	13000 K	step
	3	12500 K	step
	4	12000 K	step
	5	11500 K	step
	6	11000 K	step
	7	10500 K	step
	8	10000 K	step
	9	9500 K	step
	10	9000 K	step
	11	8600 K	step
	12	8575 K	step
	13	8550 K	step
	:	:	:
	255	2500 K	step
32		Digital Iris-type selection	
	0	Circular ,outside-->in,sharp edge	step
	1	Circular ,outside-->in,fuzzy edge 1	step
	2	Circular ,outside-->in,fuzzy edge 2	step
	3	Circular ,outside-->in,fuzzy edge 3	step
	4	Circular ,outside-->in,fuzzy edge 4 (maximum)	step
	5	Circular ,inside-->out,sharp edge	step
	6	Circular ,inside-->out,fuzzy edge 1	step

Appendix - DMX protocol

DMX Channel	DMX Value	Function	Type of control
32	7	Circular ,inside-->out,fuzzy edge 2	step
	8	Circular ,inside-->out,fuzzy edge 3	step
	9	Circular ,inside-->out,fuzzy edge 4 (maximum)	step
	10	Horizontal ellipse ,outside-->in,sharp edge	step
	11	Horizontal ellipse ,outside-->in,fuzzy edge 1	step
	12	Horizontal ellipse ,outside-->in,fuzzy edge 2	step
	13	Horizontal ellipse ,outside-->in,fuzzy edge 3	step
	14	Horizontal ellipse ,outside-->in,fuzzy edge 4 (maximum)	step
	15	Horizontal ellipse ,inside-->out,sharp edge	step
	16	Horizontal ellipse ,inside-->out,fuzzy edge 1	step
	17	Horizontal ellipse ,inside-->out,fuzzy edge 2	step
	18	Horizontal ellipse ,inside-->out,fuzzy edge 3	step
	19	Horizontal ellipse ,inside-->out,fuzzy edge 4 (maximum)	step
	20	Vertical ellipse ,outside-->in,sharp edge	step
	21	Vertical ellipse ,outside-->in,fuzzy edge 1	step
	22	Vertical ellipse ,outside-->in,fuzzy edge 2	step
	23	Vertical ellipse ,outside-->in,fuzzy edge 3	step
	24	Vertical ellipse ,outside-->in,fuzzy edge 4 (maximum)	step
	25	Vertical ellipse ,inside-->out,sharp edge	step
	26	Vertical ellipse ,inside-->out,fuzzy edge 1	step
	27	Vertical ellipse ,inside-->out,fuzzy edge 2	step
	27	Vertical ellipse ,inside-->out,fuzzy edge 3	step
	29	Vertical ellipse ,inside-->out,fuzzy edge 4 (maximum)	step
	30	Clockwise wipe,sharp edge	step
	31	Clockwise wipe,fuzzy edge 1	step
	32	Clockwise wipe,fuzzy edge 2	step
	33	Clockwise wipe,fuzzy edge 3	step
	34	Clockwise wipe,fuzzy edge 4 (maximum)	step
	35	Anticlockwise wipe,sharp edge	step
	36	Anticlockwise wipe,fuzzy edge 1	step
	37	Anticlockwise wipe,fuzzy edge 2	step
	38	Anticlockwise wipe,fuzzy edge 3	step
	39	Anticlockwise wipe,fuzzy edge 4 (maximum)	step
	40	Wedge wipe ,top-->down, sharp edge	step
	41	Wedge wipe ,top-->down, fuzzy edge 1	step
	42	Wedge wipe ,top-->down, fuzzy edge 2	step
	43	Wedge wipe ,top-->down, fuzzy edge 3	step
	44	Wedge wipe ,top-->down, fuzzy edge 4 (maximum)	step
	45	Wedge wipe ,bottom-->up, sharp edge	step
	46	Wedge wipe ,bottom-->up, fuzzy edge 1	step
	47	Wedge wipe ,bottom-->up, fuzzy edge 2	step
	48	Wedge wipe ,bottom-->up, fuzzy edge 3	step
	49	Wedge wipe ,bottom-->up, fuzzy edge 4 (maximum)	step
	50	Radial wipe ,left -->bottom,sharp edge	step
	51	Radial wipe ,left -->bottom,fuzzy edge 1	step
	52	Radial wipe ,left -->bottom,fuzzy edge 2	step
	53	Radial wipe ,left -->bottom,fuzzy edge 3	step
	54	Radial wipe ,left -->bottom,fuzzy edge 4 (maximum)	step
	55	Radial wipe ,bottom-->left,sharp edge	step
	56	Radial wipe ,bottom-->left,fuzzy edge 1	step

Appendix - DMX protocol

DMX Channel	DMX Value	Function	Type of control
32	57	Radial wipe ,bottom-->left,fuzzy edge 2	step
	58	Radial wipe ,bottom-->left,fuzzy edge 3	step
	59	Radial wipe ,bottom-->left,fuzzy edge 4 (maximum)	step
	60	Radial wipe ,top-->left,sharp edge	step
	61	Radial wipe ,top-->left,fuzzy edge 1	step
	62	Radial wipe ,top-->left,fuzzy edge 2	step
	63	Radial wipe ,top-->left,fuzzy edge 3	step
	64	Radial wipe ,top-->left,fuzzy edge 4 (maximum)	step
	65	Radial wipe ,left-->top,sharp edge	step
	66	Radial wipe ,left-->top,fuzzy edge 1	step
	67	Radial wipe ,left-->top,fuzzy edge 2	step
	68	Radial wipe ,left-->top,fuzzy edge 3	step
	69	Radial wipe ,left-->top,fuzzy edge 4 (maximum)	step
	70	Vertical barn-doors,outside-->in,sharp edge	step
	71	Vertical barn-doors,outside-->in,fuzzy edge 1	step
	72	Vertical barn-doors,outside-->in,fuzzy edge 2	step
	73	Vertical barn-doors,outside-->in,fuzzy edge 3	step
	74	Vertical barn-doors,outside-->in,fuzzy edge 4 (maximum)	step
	75	Vertical barn-doors,inside-->out,sharp edge	step
	76	Vertical barn-doors,inside-->out,fuzzy edge 1	step
	77	Vertical barn-doors,inside-->out,fuzzy edge 2	step
	78	Vertical barn-doors,inside-->out,fuzzy edge 3	step
	79	Vertical barn-doors,inside-->out,fuzzy edge 4 (maximum)	step
	80	Horizontal barn-doors,outside-->in,sharp edge	step
	81	Horizontal barn-doors,outside-->in,fuzzy edge 1	step
	82	Horizontal barn-doors,outside-->in,fuzzy edge 2	step
	83	Horizontal barn-doors,outside-->in,fuzzy edge 3	step
	84	Horizontal barn-doors,outside-->in,fuzzy edge 4 (maximum)	step
	85	Horizontal barn-doors,inside-->out,sharp edge	step
	86	Horizontal barn-doors,inside-->out,fuzzy edge 1	step
	87	Horizontal barn-doors,inside-->out,fuzzy edge 2	step
	88	Horizontal barn-doors,inside-->out,fuzzy edge 3	step
89	Horizontal barn-doors,inside-->out,fuzzy edge 4 (maximum)	step	
90	Horizontal one-way band wipe,top left-->bottom right	step	
91	Horizontal one-way band wipe,bottom right-->top left	step	
92	Horizontal one-way band wipe,top right-->bottom left	step	
93	Horizontal one-way band wipe,bottom left-->top right	step	
94	Horizontal two-way band wipe,top left-->bottom right	step	
95	Horizontal two-way band wipe,bottom right-->top left	step	
96	Horizontal two-way band wipe,top right-->bottom left	step	
97	Horizontal two-way band wipe,bottom left-->top right	step	
98	Vertical one-way band wipe,top left-->bottom right	step	
99	Vertical one-way band wipe,bottom right-->top left	step	
100	Vertical one-way band wipe,bottom left-->top right	step	
101	Vertical one-way band wipe,top right-->bottom left	step	
102	Vertical two-way band wipe,top right-->bottom left	step	
103	Vertical two-way band wipe,bottom right-->top left	step	
104	Vertical two-way band wipe,bottom left-->top right	step	
105	Vertical two-way band wipe,top right-->bottom left	step	
106	Horizontal bands 4x,top-->bottom	step	

Appendix - DMX protocol

DMX Channel	DMX Value	Function	Type of control
32	107	Horizontal bands 4x,bottom-->top	step
	108	Vertical bands 4x,left -->right	step
	109	Vertical bands 4x,right -->left	step
	110	Horizontal bands 8x,top-->bottom	step
	111	Horizontal bands 8x,bottom-->top	step
	112	Vertical bands 8x,left-->right	step
	113	Vertical bands 8x,right-->left	step
	114	Horizontal bands 16x,top-->bottom	step
	115	Horizontal bands 16x,bottom-->top	step
	116	Vertical bands 16x,left-->right	step
	117	Vertical bands 16x,right-->left	step
	118	Horizontal bands 32x,top-->bottom	step
	119	Horizontal bands 32x,bottom-->top	step
	120	Vertical bands 32x,left-->right	step
	121	Vertical bands 32x,right-->left	step
	122	Horizontal crossing 4x	step
	123	Horizontal crossing 4x,inverse	step
	124	Vertical crossing 4x	step
	125	Vertical crossing 4x,inverse	step
	126	Horizontal crossing 8x	step
	127	Horizontal crossing 8x,inverse	step
	128	Vertical crossing 8x	step
	129	Vertical crossing 8x,inverse	step
	130	Horizontal crossing 16x	step
	131	Horizontal crossing 16x,inverse	step
	132	Vertical crossing 16x	step
	133	Vertical crossing 16x,inverse	step
	134	Checker wipe 3x4, left-->right	step
	135	Checker wipe 3x4, right-->left	step
	136	Checker wipe 4x4, left-->right	step
	137	Checker wipe 4x4, right-->left	step
	138	Checker wipe 5x8, left-->right	step
139	Checker wipe 5x8, right-->left	step	
140	Checker wipe 9x8, left-->right	step	
141	Checker wipe 9x8, right-->left	step	
142	Checker wipe 9x16, left-->right	step	
143	Checker wipe 9x16, right-->left	step	
144	Checker wipe 10x32, left-->right	step	
145	Checker wipe 10x32, right-->left	step	
146	2 diagonal curtains, bottom left-->center<-- top right	step	
147	2 diagonal curtains, top left-->center<-- bottom right	step	
148	Grid wipe 8x8,bottom right-->top left	step	
149	Grid wipe 8x8,bottom right-->top left,inverse	step	
150	Grid wipe 8x8,top right-->bottom left	step	
151	Grid wipe 8x8,top right-->bottom left,inverse	step	
152	Grid wipe 16x16,bottom right-->top left	step	
153	Grid wipe 16x16,bottom right-->top left,inverse	step	
154	Grid wipe 16x16,top right-->bottom left	step	
155	Grid wipe 16x16,top right-->bottom left,inverse	step	
156	Grid wipe 32x32,bottom right-->top left	step	

Appendix - DMX protocol

DMX Channel	DMX Value	Function	Type of control
32	157	Grid wipe 32x32,bottom right-->top left,inverse	step
	158	Grid wipe 32x32,top right-->bottom left	step
	159	Grid wipe 32x32,top right-->bottom left,inverse	step
	160	4 sliding triangles	step
	161-255	Reserved	step
33		Digital Iris	
	0	Open iris	step
	1-254	From max. diameter to min. diameter	proportional
	255	Closed iris	step
34		Digital Iris fine	
	0-255	Iris fine	proportional
35		Digital strobe	
	0 - 30	Open light output	step
	31 - 80	Digital strobe-effect from slow to fast	proportional
	81 - 110	Open light output	step
	111 - 140	Random digital strobe-effect from slow to fast	proportional
	141 - 149	Open light output	step
	150 - 154	Iris displays current gobo from gobo layer 1	step
	155 - 159	Iris displays current gobo from gobo layer 2	step
	160 - 164	Iris displays current gobo from gobo layer 3	step
	165 - 189	Reserved	
	190-194	Banner displays current gobo from gobo layer 1	step
	195-199	Banner displays current gobo from gobo layer 2	step
	200 - 204	Banner displays current gobo from gobo layer 3	step
	205-244	Reserved	
	245-249	Digital strobe closed	step
	250-255	Mechanical shutter closed	step
36		Banner left positioning	
	0-255	Positioning from left to right (0-default)	proportional
37		Banner left rotation	
	0-255	Rotation +/- 45° (128-default)	proportional
38		Banner right positioning	
	0-255	Positioning from right to left (0-default)	proportional
39		Banner right rotation	
	0-255	Rotation +/- 45° (128-default)	proportional
40		Banner top positioning	
	0-255	Positioning from top to bottom (0-default)	proportional
41		Banner top rotation	
	0-255	Rotation +/- 45° (128-default)	proportional
42		Banner bottom positioning	
	0-255	Positioning from bottom to top (0-default)	proportional
43		Banner bottom rotation	
	0-255	Rotation +/- 45° (128-default)	proportional
44		All Banners rotation	
	0-255	Rotation +/- 45° (128-default)	proportional
45		Global Effect 1	
	0	No effect	
	1	Picture merging -selection of width of overlapping edges: Width of overlapping edges -10 %	P1, P2, P3

Appendix - DMX protocol

DMX Channel	DMX Value	Function	Type of control	
	2	Width of overlapping edges - 0 %	P1, P2, P3	
	3	Width of overlapping edges - 15 %	P1, P2, P3	
	4	Width of overlapping edges - 20 %	P1, P2, P3	
	5	Width of overlapping edges - 25 %	P1, P2, P3	
	6	Width of overlapping edges - 30 %	P1, P2, P3	
	7	Width of overlapping edges - 35 %	P1, P2, P3	
	8-10			
		<u>Picture merging -selection of width of overlapping edges for pre-cropped content mode:</u>		
	11	Width of overlapping edges -10 %	P1, P2, P3	
	12	Width of overlapping edges - 0 %	P1, P2, P3	
	13	Width of overlapping edges - 15 %	P1, P2, P3	
	14	Width of overlapping edges - 20 %	P1, P2, P3	
	15	Width of overlapping edges - 25 %	P1, P2, P3	
	16	Width of overlapping edges - 30 %	P1, P2, P3	
	17	Width of overlapping edges - 35 %	P1, P2, P3	
		<i>P1- field configuration, P2- segment selection, P3- segment edge</i>		
	18-255	Reserved		
	46		Global effect 1- Parameter 1	
0		None		
		<u>Image field configuration for Picture merging</u>		
1-109		Non-mirrored configurations	step	
110-127		Reserved		
128-163		Horizontally mirrored configurations	step	
164-199		Vertically mirrored configurations	step	
200-235		Horizontally and vertically mirrored configurations	step	
236-255	Reserved			
47		Global effect 1- Parameter 2		
	0-255	<u>Segment selection for Pixture merging</u>	step	
48		Global effect 1- Parameter 3		
	0-171	<u>Segment edge display for Pixture merging</u>	step	
	172-255	Reserved		
49		Global Effect 2		
	0	None		
	1	Vertical inside corner mapping	P1, P2,P3	
	2	Vertical outside corner mapping	P1, P2,P3	
	3	Horizontal inside corner mapping	P1, P2,P3	
	4	Horizontal outside corner mapping	P1, P2,P3	
	5	Vertical convex cylinder mapping	P1, P2,P3	
	6	Vertical concave cylinder mapping	P1, P2,P3	
	7	Horizontal convex cylinder mapping	P1, P2,P3	
	8	Horizontal concave cylinder mapping	P1, P2,P3	
	9	Orthographic sphere mapping	P1, P2,P3	
	10	Rectangle on circle (sphere) mapping*	P1, P2,P3	
	11	Square on circle (sphere) mapping*	P1, P2,P3	
	12	Rectangle on circle (sphere) mapping with picture merging	P1, P2,P3	
	13-19	Reserved		
	20	Picture merging - R/G/B gamma adjustment in blended edges	P1, P2,P3	
	<i>P 1- red, P 2 - green, P 3- blue</i>			
21-255	Reserved			

Appendix - DMX protocol

DMX Channel	DMX Value	Function	Type of control	
50		Global Effect 2 - Parameter 1		
	0-255	Function depends on selected Global Effect 2	depends on effect	
51		Global Effect 2 - Parameter 2		
	0-255	Function depends on selected Global Effect 2	depends on effect	
52		Global Effect 2 - Parameter 3		
	0-255	Function depends on selected Global Effect 2	depends on effect	
Gobo layer 1				
53		Dimmer		
	0-255	Dimmer intensity from 0% to 100% (255-default)	proportional	
54		Gobo Folder selection		
	0-20	Factory folders	step	
	21-240	User folders	step	
	241-250	Reserved		
	251	Live input (grab. card)-see channel 55	step	
	252	Streaming from remote sources	step	
	253-255	Reserved		
55		Gobo selection		
	0	White	step	
	1-255	255 Gobos (one by one)	step	
		<i>If Live input (251 DMX) is selected on channel 54</i>		
	0	White screen	step	
	1-20	Video composite input-PAL system	step	
	21-40	SVIDEO input- PAL system	step	
	21-60	Video composite input-NTSC system	step	
	61-80	SVIDEO input- NTSC system	step	
	81-100	Video composite input-SECAM system	step	
	101-120	SVIDEO input- SECAM system	step	
	121-255	Reserved		
	56		In Frame High	
		0-255	Defines the beginning of a media file segment as a percentage of the movie length (0-default)	proportional
57		In Frame Low		
	0-255	Defines the beginning of a media file segment as a percentage of the movie length (0-default)	proportional	
58		Out Frame High		
	0-255	Defines the end of a media file segment as a percentage of the movie length (255-default)	proportional	
59		Out Frame Low		
	0-255	Defines the beginning of a media file segment as a percentage of the movie length (255-default)	proportional	
60		Gobo control		
		<u>Copy mode</u>		
		<i>Video stream 1:</i>		
	0	Play forward if dimmer (on layer 1) > 0, looping continuously	step	
	1	Play forward if dimmer (on layer 1) > 0, hold on last frame	step	
	2	Pause	step	
	3	Play forward in continuous loop	step	
	4	Play forward once and hold on the last frame	step	
5	No function			

Appendix - DMX protocol

DMX Channel	DMX Value	Function	Type of control
60	6	Scrub (Display) the selected In Frame	step
	7	Scrub (Display) the selected Out Frame	step
	8-9	Reserved	
		<i>Video stream 2 (the same functionality as for Video stream 1):</i>	
	10	Play forward if dimmer (on layer 1) > 0, looping continuously	step
	11	Play forward if dimmer (on layer 1) > 0, hold on last frame	step
	12	Pause	step
	13	Play forward in continuous loop	step
	14	Play forward once and hold on the last frame	step
	15	No function	
	16	Scrub (Display) the selected In Frame	step
	17	Scrub (Display) the selected Out Frame	step
	18-19	Reserved	
		<u>Addition mode</u>	
		<i>Video stream 1:</i>	
	20	Play forward if dimmer (on layer 1) > 0, looping continuously	step
	21	Play forward if dimmer (on layer 1) > 0, hold on last frame	step
	22	Pause	step
	23	Play forward in continuous loop	step
	24	Play forward once and hold on the last frame	step
	25	No function	
	26	Scrub (Display) the selected In Frame	step
	27	Scrub (Display) the selected Out Frame	step
	28-29	Reserved	
		<i>Video stream 2:</i>	
	30-37	<i>The same functionality as for Video stream 1</i>	step
	38-39	Reserved	
		<u>Substraction mode</u>	
		<i>Video stream 1:</i>	
	40	Play forward if dimmer (on layer 1) > 0, looping continuously	step
	41	Play forward if dimmer (on layer 1) > 0, hold on last frame	step
	42	Pause	step
	43	Play forward in continuous loop	step
	44	Play forward once and hold on the last frame	step
	45	No function	
	46	Scrub (Display) the selected In Frame	step
	47	Scrub (Display) the selected Out Frame	step
	48-49	Reserved	
		<i>Video stream 2:</i>	
	50-57	<i>The same functionality as for Video stream 1</i>	step
	58-59	Reserved	
		<u>Multiplication mode</u>	
		<i>Video stream 1:</i>	
	60	Play forward if dimmer (on layer 1) > 0, looping continuously	step
	61	Play forward if dimmer (on layer 1) > 0, hold on last frame	step
	62	Pause	step
	63	Play forward in continuous loop	step
	64	Play forward once and hold on the last frame	step
	65	No function	
	66	Scrub (Display) the selected In Frame	step

Appendix - DMX protocol

DMX Channel	DMX Value	Function	Type of control
60	67	Scrub (Display) the selected Out Frame	step
	68-69	Reserved	
		<i>Video stream 2:</i>	
	70-77	<i>The same functionality as for Video stream 1</i>	step
	78-79	Reserved	
		<u>Minimum mode</u>	
		<i>Video stream 1:</i>	
	80	Play forward if dimmer (on layer 1) > 0, looping continuously	step
	81	Play forward if dimmer (on layer 1) > 0, hold on last frame	step
	82	Pause	step
	83	Play forward in continuous loop	step
	84	Play forward once and hold on the last frame	step
	85	No function	
	86	Scrub (Display) the selected In Frame	step
	87	Scrub (Display) the selected Out Frame	step
	88-89	Reserved	
		<i>Video stream 2:</i>	
	90-97	<i>The same functionality as for Video stream 1</i>	
	98-99	Reserved	
		<u>Maximum mode</u>	
		<i>Video stream 1:</i>	
	100	Play forward if dimmer (on layer 1) > 0, looping continuously	step
	101	Play forward if dimmer (on layer 1) > 0, hold on last frame	step
	102	Pause	step
	103	Play forward in continuous loop	step
	104	Play forward once and hold on the last frame	step
	105	No function	
	106	Scrub (Display) the selected In Frame	step
107	Scrub (Display) the selected Out Frame	step	
108-109	Reserved		
	<i>Video stream 2:</i>		
110-117	<i>The same functionality as for Video stream 1</i>	step	
118-255	Reserved		
61		Playback Speed	
	0	Normal Speed	step
	1-127	Slow speeds from slowest ---> normal	proportional
	128	Normal Speed	step
	129-255	Faster than Normal ---> Fastest	proportional
62		Gobo rotation and indexing	
	0-63	Clockwise rotation from fast to slow	proportional
	64-127	Indexing	proportional
	128	No rotation-centre (128-default)	step
	129-192	Indexing	proportional
193-255	Anticlockwise rotation from slow to fast	proportional	
63		Gobo fine indexing (rotation)	
	0-255	Fine indexing (rotation)	proportional
64		Gobo effect 1 Selection	
	0	No effect	
	1	Zoom sinus	P1-speed
	2	Zoom bump in fade out	P1-speed

Appendix - DMX protocol

DMX Channel	DMX Value	Function	Type of control					
64	3	Zoom fade in bump out	P1-speed					
	4	Reserved						
	5	Zoom in fade	P1-speed					
	6	Zoom out fade	P1-speed					
	7	Scale xy sinus	P1-speed					
	8	Reserved						
	9	Reserved						
	10	Reserved						
	11	XY pos. circle counter-clockwise	P1-speed					
	12	XY pos. circle clockwise	P1-speed					
	13	XY pos. scroll up	P1-speed					
	14	XY pos. scroll down	P1-speed					
	15	XY pos. scroll left	P1-speed					
	16	XY pos. scroll right	P1-speed					
	17	Right-left diag. down scroll	P1-speed					
	18	Right-left diag. up scroll	P1-speed					
	19	Left-right diag. down scroll	P1-speed					
	20	Left-right diag. up scroll	P1-speed					
	21	X rotate	P1-speed					
	22	Y rotate	P1-speed					
	23	XY rotate	P1-speed					
	24	XY inv. rotate	P1-speed					
	25	X inv. y rotate	P1-speed					
	26	Tile xy	P1-amount					
	27	Tile xy	P1-speed					
	28	XYZ rot. cube	P1-speed					
	29	XYZ rot. sphere	P1-speed					
	30	X rot. cylinder	P1-speed					
	31	Y rot. cylinder	P1-speed					
	32	Reserved						
	33	Kaleidoscope	none					
	34	Squeeze in	none					
	35	Squeeze out	none					
	36	Bend X	none					
	37	Bend Y	none					
	38	Tile frame	none					
	39	Frame	none					
	40	Plane Flip X	none					
	41	Plane Flip Y	none					
	42	Plane Flip XY	none					
	43	Plane mirror X top	none					
	44	Plane mirror X bottom	none					
	45	Plane mirror Y left	none					
	46	Plane mirror Y right	none					
	47	Plane mirror XY segment 1	<table border="1"> <tr> <td>segment 1</td> <td>segment 2</td> </tr> <tr> <td>segment 4</td> <td>segment 3</td> </tr> </table>	segment 1	segment 2	segment 4	segment 3	none
	segment 1	segment 2						
	segment 4	segment 3						
	48	Plane mirror XY segment 2		none				
	49	Plane mirror XY segment 3	none					
	50	Plane mirror XY segment 4	none					
	51	Plane tile 2x	none					
	52	Plane tile 3x	none					

Appendix - DMX protocol

DMX Channel	DMX Value	Function	Type of control	
64	53	Plane tile 4x	none	
	54	Plane tile 5x	none	
	55	Plane cross tile 2x	none	
	56	Plane cross tile 2x inverse	none	
	57	Plane cross tile 3x	none	
	58	Plane cross tile 3x inverse	none	
	59	Plane cross tile 4x	none	
	60	Plane cross tile 4x inverse	none	
	61	Plane cross tile 5x	none	
	62	Plane cross tile 5x inverse	none	
	63	Plane cross tiler 5x	none	
	64	Plane cross tiler 5x inverse	none	
	65	Plane bar	none	
	66	Plane bar inverse	none	
	67	Plane bar left-right	none	
	68	Plane bar top-bottom	none	
	69	Reserved		
	70	Reserved		
	71	Gobo disc	none	
	72	Gobo disc Flip X	none	
	73	Gobo disc Flip Y	none	
	74	Gobo disc Flip XY	none	
	75	Gobo disc mirror X	none	
	76	Gobo disc mirror Y	none	
	77	Gobo disc mirror XY	none	
	78-79	Reserved		
	80	Plane mirror X top inverse	none	
	81	Plane mirror X bottom inverse	none	
	82	Plane mirror Y left inverse	none	
	83	Plane mirror Y right inverse	none	
	84	Plane mirror XY inverse	none	
	85	Plane mirror X-inverse,Y	none	
	86	Plane mirror X,Y-inverse	none	
	87-89	Reserved		
	90	Circular effect (Fish eye)	P1, P2, P3	
		<i>P1-character, P2-X ratio, P3-Y ratio</i>		
	91-99	Reserved		
		<i>kaleidoscope - mode and mosaic segment selection:</i>		
	100	Square -static mode	P1, P2, P3	
	101	Square -dynamic mode	P1, P2, P3	
	102	Right triangular - static mode	P1, P2, P3	
	103	Right triangular - dynamic mode	P1, P2, P3	
	104	Isosceles triangular - static mode	P1, P2, P3	
	105	Isosceles triangular - dynamic mode	P1, P2, P3	
106	Triangular 1 - static mode	P1, P2, P3		
107	Triangular 1 -dynamic mode	P1, P2, P3		
108	Triangular 2 -static mode	P1, P2, P3		
109	Triangular 2 - dynamic mode	P1, P2, P3		
110	Centered kaleidoscope (rough)-static mode	P1, P2, P3		
111	Centered kaleidoscope (rough)-dynamic mode	P1, P2, P3		

Appendix - DMX protocol

DMX Channel	DMX Value	Function	Type of control
	112	Centered kaleidoscope (fine)-static mode	P1, P2, P3
	113	Centered kaleidoscope (fine)-dynamic mode	P1, P2, P3
		<i>Stat. mode:P1-density, P2-content (coarse), P3-content (fine)</i>	
		<i>Dyn. mode:P1-density, P2-size and pulsation, P3-movement</i>	
	114-149	Reserved	
	150	Layer keystoneing	P1,P2,P3
		<i>P1-skewing in X, P2-skewing in Y, P3-squeezing/stretching in Y</i>	
	151-255	Reserved	
65		Gobo effect 1 - Parameter 1	
	0-255	Effect control	depends on effect
66		Gobo effect 1 - Parameter 2	
	0-255	Effect control	depends on effect
67		Gobo effect 1 - Parameter 3	
	0-255	Effect control	depends on effect
68		Gobo effect 2 Selection	
	0	No effect	
	1	Colour to black and white	P1-amount
	2	Colour to black and white inverse	P1-amount
	3	Black and white to black and white inverse	P1-amount
	4	Inversion	P1-amount
	5	Black Mask	P1-amount
	6	Black Mask inverse	P1-amount
	7	Contrast	P1-amount
	8	Brightness	P1-amount
	9	RGB to GBR	P1-amount
	10	RGB to BRG	P1-amount
	11	RGB to RBG	P1-amount
	12	Black and white to black and white inverse timed	P1-speed
	13	Colour to black and white timed	P1-speed
	14	Colour to inverse timed	P1-speed
	15	Cycle	P1-speed
	16	Cycle inverse	P1-speed
	17	Reserved	
	18	Reserved	
	19	Colour Key	P1-amount
	20	Colour Key inverse	P1-amount
	21	Key Black	P1-amount
	22	Key Black inverse	P1-amount
	23	Key White	P1-amount
	24	Key White inverse	P1-amount
	25	White flash	P1-amount
	26	Black flash	P1-amount
	27	Alpha flash	P1-amount
	28	Invert flash	P1-amount
	29	BW Flash	P1-amount
	30	Black and white to black and white inverse Flash	P1-amount
	31	Gradient Wipe X	P1-amount
32	Gradient Wipe Y	P1-amount	
	33-39	Reserved	
	40	Gaussian filter	P1-amount

Appendix - DMX protocol

DMX Channel	DMX Value	Function	Type of control
	41	Mean filter	P1-amount
	42	Laplacian filter	P1-amount
	43	Emboss filter	P1-amount
	44	Sharpness filter	P1-amount
	45-49	Reserved	
		RGB effects:	
	50	RGB subtract All Pixels	P1, P2, P3
	51	RGB add All Pixels	P1, P2, P3
	52	RGB add non-black Pixels	P1, P2, P3
	53	RGB subtract/add All Pixels	P1, P2, P3
	54	Swap RGB to RBG	P1, P2, P3
	55	Swap RGB to GRB	P1, P2, P3
	56	Swap RGB to GBR	P1, P2, P3
	57	Swap RGB to BRG	P1, P2, P3
	58	Swap RGB to BGR	P1, P2, P3
	59	RGB invert	P1, P2, P3
	60	Invert and swap RGB to BRG	P1, P2, P3
	61	Invert and swap RGB to GBR	P1, P2, P3
	62	Colour to Alpha	P1, P2, P3
	63	Colour to Alpha inverted	P1, P2, P3
	64-67	Reserved	
	68	RGB scale <i>P1-red, P2-green, P3-blue</i>	P1, P2, P3
	69	Brightness scale <i>P1, P2 - inclination of conversion line</i>	P1, P2
	70-149	Reserved	
	150	Layer keystoneing <i>P1-squeezing/stretching in X, P2/P3-compressing & expanding in X/Y</i>	P1,P2,P3
151-255	Reserved		
69		Gobo effect 2 -Parameter 1	
	0-255	Effect control	depends on effect
70		Gobo effect 2 -Parameter 2	
	0-255	Effect control	depends on effect
71		Gobo effect 2 -Parameter 3	
	0-255	Effect control	depends on effect
72		Gobo Position X coarse	
	0-127	Movement forward	proportional
	128	Centre (128-default)	step
	129-255	Movement backward	proportional
73		Gobo position X fine	
	0-255	Position X fine	proportional
74		Gobo position Y coarse	
	0-127	Movement down	proportional
	128	Centre (128-default)	step
	129-255	Movement up	proportional
75		Gobo position Y fine	
	0-255	Position Y fine	proportional
76		Gobo zoom X coarse	
	0-127	Narrowing	proportional

Appendix - DMX protocol

DMX Channel	DMX Value	Function	Type of control
	128	Centre (128-default)	step
	129-255	Widening	proportional
77		Gobo zoom X fine	
	0-255	Zoom X fine	proportional
78		Gobo zoom Y coarse	
	0-127	Narrowing	proportional
	128	Centre (128-default)	step
	129-255	Widening	proportional
79		Gobo zoom Y fine	
	0-255	Zoom Y fine	proportional
80		Synchronization to ID	
	0	No function	step
	1-255	Synchronization to fixture ID	proportional
Gobo layer 2			
81		Dimmer	
	0-255	Dimmer intensity from 0% to 100% (255-default)	proportional
82		Gobo Folder selection	
	0-20	Factory folders	step
	21-240	User folders	step
	241-250	Reserved	
	251	Live input (grab. card)-see channel 83	step
	252	Streaming from remote sources	step
	253-255	Reserved	
83		Gobo selection	
	0	White	step
	1-255	255 Gobos (one by one)	step
		<i>If Live input (251 DMX) is selected on channel 82:</i>	
	0	White screen	step
	1-20	Video composite input-PAL system	step
	21-40	SVIDEO input- PAL system	step
	21-60	Video composite input-NTSC system	step
	61-80	SVIDEO input- NTSC system	step
	81-100	Video composite input-SECAM system	step
	101-120	SVIDEO input- SECAM system	step
121-255	Reserved		
84		In Frame High	
	0-255	Defines the beginning of a media file segment as a percentage of the movie length (0-default)	proportional
85		In Frame Low	
	0-255	Defines the beginning of a media file segment as a percentage of the movie length (0-default)	proportional
86		Out Frame High	
	0-255	Defines the end of a media file segment as a percentage of the movie length (255-default)	proportional
87		Out Frame Low	
	0-255	Defines the beginning of a media file segment as a percentage of the movie length (255-default)	proportional

Appendix - DMX protocol

DMX Channel	DMX Value	Function	Type of control
88		Gobo control	
		<u>Copy mode</u>	
		<i>Video stream 1</i>	
	0	Play forward if dimmer (on layer 2) > 0, looping continuously	step
	1	Play forward if dimmer (on layer 2) > 0, hold on last frame	step
	2	Pause	step
	3	Play forward in continuous loop	step
	4	Play forward once and hold on the last frame	step
	5	No function	
	6	Scrub (Display) the selected In Frame	step
	7	Scrub (Display) the selected Out Frame	step
	8-9	Reserved	
		<i>Video stream 2 (the same functionality as for Video stream 1):</i>	
	10	Play forward if dimmer (on layer 2) > 0, looping continuously	step
	11	Play forward if dimmer (on layer 2) > 0, hold on last frame	step
	12	Pause	step
	13	Play forward in continuous loop	step
	14	Play forward once and hold on the last frame	step
	15	No function	
	16	Scrub (Display) the selected In Frame	step
	17	Scrub (Display) the selected Out Frame	step
	18-19	Reserved	
		<u>Addition mode</u>	
		<i>Video Stream 1</i>	
	20	Play forward if dimmer (on layer 2) > 0, looping continuously	step
	21	Play forward if dimmer (on layer 2) > 0, hold on last frame	step
	22	Pause	step
	23	Play forward in continuous loop	step
	24	Play forward once and hold on the last frame	step
	25	No function	
	26	Scrub (Display) the selected In Frame	step
	27	Scrub (Display) the selected Out Frame	step
	28-29	Reserved	
		<i>Video stream 2</i>	
	30-37	<i>the same functionality as for Video stream 1</i>	step
	38-39	Reserved	
		<u>Substraction mode</u>	
		<i>Video Stream 1</i>	
	40	Play forward if dimmer (on layer 2) > 0, looping continuously	step
	41	Play forward if dimmer (on layer 2) > 0, hold on last frame	step
	42	Pause	step
	43	Play forward in continuous loop	step
	44	Play forward once and hold on the last frame	step
	45	No function	
	46	Scrub (Display) the selected In Frame	step
	47	Scrub (Display) the selected Out Frame	step
	48-49	Reserved	
		<i>Video Stream 2</i>	
	50-57	<i>the same functionality as for Video stream 1</i>	step
	58-59	Reserved	

Appendix - DMX protocol

DMX Channel	DMX Value	Function	Type of control
88		<u>Multiplication mode</u>	
		<i>Video stream 1</i>	
	60	Play forward if dimmer (on layer 2) > 0, looping continuously	step
	61	Play forward if dimmer (on layer 2) > 0, hold on last frame	step
	62	Pause	step
	63	Play forward in continuous loop	step
	64	Play forward once and hold on the last frame	step
	65	No function	
	66	Scrub (Display) the selected In Frame	step
	67	Scrub (Display) the selected Out Frame	step
	68-69	Reserved	
		<i>Video Stream 2</i>	
	70-77	<i>the same functionality as for Video stream 1</i>	step
	78-79	Reserved	
		<u>Minimum mode</u>	
		<i>Video stream 1</i>	
	80	Play forward if dimmer (on layer 2) > 0, looping continuously	step
	81	Play forward if dimmer (on layer 2) > 0, hold on last frame	step
	82	Pause	step
	83	Play forward in continuous loop	step
	84	Play forward once and hold on the last frame	step
	85	No function	
	86	Scrub (Display) the selected In Frame	step
	87	Scrub (Display) the selected Out Frame	step
	88-89	Reserved	
		<i>Video Stream 2</i>	
	90-97	<i>the same functionality as for Video stream 1</i>	step
	98-99	Reserved	
		<u>Maximum mode</u>	
		<i>Video stream 1</i>	
	100	Play forward if dimmer (on layer 2) > 0, looping continuously	step
	101	Play forward if dimmer (on layer 2) > 0, hold on last frame	step
102	Pause	step	
103	Play forward in continuous loop	step	
104	Play forward once and hold on the last frame	step	
105	No function		
106	Scrub (Display) the selected In Frame	step	
107	Scrub (Display) the selected Out Frame	step	
108-109	Reserved		
	<i>Video Stream 2</i>		
110-117	<i>the same functionality as for Video stream 1</i>	step	
118-255	Reserved		
89		Playback Speed	
	0	Normal Speed	step
	1-127	Slow speeds from slowest ---> normal	proportional
	128	Normal Speed	step
129-255	Faster than Normal ---> Fastest	proportional	
90		Gobo rotation and indexing	
	0-63	Clockwise rotation from fast to slow	proportional
	64-127	Indexing	proportional

Appendix - DMX protocol

DMX Channel	DMX Value	Function	Type of control
	128	No rotation-centre (128-default)	step
	129-192	Indexing	proportional
	193-255	Anticlockwise rotation from slow to fast	proportional
91		Gobo fine indexing (rotation)	
	0-255	Fine indexing (rotation)	proportional
92		Gobo effect 1 Selection	
	0	No effect	
	1	Zoom sinus	P1-speed
	2	Zoom bump in fade out	P1-speed
	3	Zoom fade in bump out	P1-speed
	4	Reserved	
	5	Zoom in fade	P1-speed
	6	Zoom out fade	P1-speed
	7	Scale xy sinus	P1-speed
	8	Reserved	
	9	Reserved	
	10	Reserved	
	11	XY pos. circle counter-clockwise	P1-speed
	12	XY pos. circle clockwise	P1-speed
	13	XY pos. scroll up	P1-speed
	14	XY pos. scroll down	P1-speed
	15	XY pos. scroll left	P1-speed
	16	XY pos. scroll right	P1-speed
	17	Right-left diag. down scroll	P1-speed
	18	Right-left diag. up scroll	P1-speed
	19	Left-right diag. down scroll	P1-speed
	20	Left-right diag. up scroll	P1-speed
	21	X rotate	P1-speed
	22	Y rotate	P1-speed
	23	XY rotate	P1-speed
	24	XY inv. rotate	P1-speed
	25	X inv. y rotate	P1-speed
	26	Tile xy	P1-amount
	27	Tile xy	P1-speed
	28	XYZ rot. cube	P1-speed
	29	XYZ rot. sphere	P1-speed
	30	X rot. cylinder	P1-speed
	31	Y rot. cylinder	P1-speed
	32	Reserved	
	33	Kaleidoscope	none
	34	Squeeze in	none
	35	Squeeze out	none
	36	Bend X	none
	37	Bend Y	none
	38	Tile frame	none
	39	Frame	none
	40	Plane Flip X	none
	41	Plane Flip Y	none
	42	Plane Flip XY	none
	43	Plane mirror X top	none

Appendix - DMX protocol

DMX Channel	DMX Value	Function	Type of control					
92	44	Plane mirror X bottom	none					
	45	Plane mirror Y left	none					
	46	Plane mirror Y right	none					
	47	Plane mirror XY segment 1	<table border="1"> <tr> <td>segment 1</td> <td>segment 2</td> </tr> <tr> <td>segment 4</td> <td>segment 3</td> </tr> </table>	segment 1	segment 2	segment 4	segment 3	none
	segment 1	segment 2						
	segment 4	segment 3						
	48	Plane mirror XY segment 2		none				
	49	Plane mirror XY segment 3	none					
	50	Plane mirror XY segment 4	none					
	51	Plane tile 2x	none					
	52	Plane tile 3x	none					
	53	Plane tile 4x	none					
	54	Plane tile 5x	none					
	55	Plane cross tile 2x	none					
	56	Plane cross tile 2x inverse	none					
	57	Plane cross tile 3x	none					
	58	Plane cross tile 3x inverse	none					
	59	Plane cross tile 4x	none					
	60	Plane cross tile 4x inverse	none					
	61	Plane cross tile 5x	none					
	62	Plane cross tile 5x inverse	none					
	63	Plane cross tiler 5x	none					
	64	Plane cross tiler 5x inverse	none					
	65	Plane bar	none					
	66	Plane bar inverse	none					
	67	Plane bar left-right	none					
	68	Plane bar top-bottom	none					
	69	Reserved						
	70	Reserved						
	71	Gobo disc	none					
	72	Gobo disc Flip X	none					
	73	Gobo disc Flip Y	none					
	74	Gobo disc Flip XY	none					
	75	Gobo disc mirror X	none					
	76	Gobo disc mirror Y	none					
	77	Gobo disc mirror XY	none					
	78-79	Reserved						
	80	Plane mirror X top inverse	none					
	81	Plane mirror X bottom inverse	none					
	82	Plane mirror Y left inverse	none					
	83	Plane mirror Y right inverse	none					
	84	Plane mirror XY inverse	none					
	85	Plane mirror X-inverse,Y	none					
	86	Plane mirror X,Y-inverse	none					
	87-89	Reserved						
	90	Circular effect (Fish eye)	P1, P2, P3					
			<i>P1-character, P2-X ratio, P3-Y ratio</i>					
	91-99	Reserved						
		<i>kaleidoscope - mode and mosaic segment selection:</i>						
		100	Square -static mode	P1, P2, P3				
		101	Square -dynamic mode	P1, P2, P3				
		102	Right triangular - static mode	P1, P2, P3				

Appendix - DMX protocol

DMX Channel	DMX Value	Function	Type of control	
	103	Right triangular - dynamic mode	P1, P2, P3	
	104	Isosceles triangular - static mode	P1, P2, P3	
	105	Isosceles triangular - dynamic mode	P1, P2, P3	
	106	Triangular 1 - static mode	P1, P2, P3	
	107	Triangular 1 -dynamic mode	P1, P2, P3	
	108	Triangular 2 -static mode	P1, P2, P3	
	109	Triangular 2 - dynamic mode	P1, P2, P3	
	110	Centered kaleidoscope (rough)-static mode	P1, P2, P3	
	111	Centered kaleidoscope (rough)-dynamic mode	P1, P2, P3	
	112	Centered kaleidoscope (fine)-static mode	P1, P2, P3	
	113	Centered kaleidoscope (fine)-dynamic mode	P1, P2, P3	
			<i>Stat. mode:P1-density, P2-content (coarse), P3-content (fine)</i>	
			<i>Dyn. mode:P1-density, P2-size and pulsation, P3-movement</i>	
	114-149	Reserved		
	150	Layer keystoneing		P1,P2,P3
		<i>P1-skewing in X, P2-skewing in Y, P3-squeezing/stretching in Y</i>		
151-255	Reserved			
93		Gobo effect 1 - Parameter 1		
	0-255	Effect control	depends on effect	
94		Gobo effect 1 - Parameter 2		
	0-255	Effect control	depends on effect	
95		Gobo effect 1 - Parameter 3		
	0-255	Effect control	depends on effect	
96		Gobo effect 2 Selection		
	0	No effect		
	1	Colour to black and white	P1-amount	
	2	Colour to black and white inverse	P1-amount	
	3	Black and white to black and white inverse	P1-amount	
	4	Inversion	P1-amount	
	5	Black Mask	P1-amount	
	6	Black Mask inverse	P1-amount	
	7	Contrast	P1-amount	
	8	Brightness	P1-amount	
	9	RGB to GBR	P1-amount	
	10	RGB to BRG	P1-amount	
	11	RGB to RBG	P1-amount	
	12	Black and white to black and white inverse timed	P1-speed	
	13	Colour to black and white timed	P1-speed	
	14	Colour to inverse timed	P1-speed	
	15	Cycle	P1-speed	
	16	Cycle inverse	P1-speed	
	17	Reserved		
	18	Reserved		
	19	Colour Key	P1-amount	
	20	Colour Key inverse	P1-amount	
	21	Key Black	P1-amount	
	22	Key Black inverse	P1-amount	
	23	Key White	P1-amount	
	24	Key White inverse	P1-amount	
	25	White flash	P1-amount	

Appendix - DMX protocol

DMX Channel	DMX Value	Function	Type of control
96	26	Black flash	P1-amount
	27	Alpha flash	P1-amount
	28	Invert flash	P1-amount
	29	BW Flash	P1-amount
	30	Black and white to black and white inverse Flash	P1-amount
	31	Gradient Wipe X	P1-amount
	32	Gradient Wipe Y	P1-amount
	33-39	Reserved	
	40	Gaussian filter	P1-amount
	41	Mean filter	P1-amount
	42	Laplacian filter	P1-amount
	43	Emboss filter	P1-amount
	44	Sharpness filter	P1-amount
	45-49	Reserved	
			RGB effects:
	50	RGB subtract All Pixels	P1, P2, P3
	51	RGB add All Pixels	P1, P2, P3
	52	RGB add non-black Pixels	P1, P2, P3
	53	RGB subtract/add All Pixels	P1, P2, P3
	54	Swap RGB to RBG	P1, P2, P3
	55	Swap RGB to GRB	P1, P2, P3
	56	Swap RGB to GBR	P1, P2, P3
	57	Swap RGB to BRG	P1, P2, P3
	58	Swap RGB to BGR	P1, P2, P3
	59	RGB invert	P1, P2, P3
	60	Invert and swap RGB to BRG	P1, P2, P3
	61	Invert and swap RGB to GBR	P1, P2, P3
	62	Colour to Alpha	P1, P2, P3
	63	Colour to Alpha inverted	P1, P2, P3
	64-67	Reserved	
	68	RGB scale	P1, P2, P3
		<i>P1-red, P2-green, P3-blue</i>	
	69	Brightness scale	P1, P2
		<i>P1, P2 - inclination of conversion line</i>	
	70-149	Reserved	
	150	Layer keystoneing	P1,P2,P3
		<i>P1-squeezing/stretching in X, P2/P3-compressing & expanding in X/Y</i>	
	151-255	Reserved	
97		Gobo effect 2 -Parameter 1	
	0-255	Effect control	depends on effect
98		Gobo effect 2 -Parameter 2	
	0-255	Effect control	depends on effect
99		Gobo effect 2 -Parameter 3	
	0-255	Effect control	depends on effect
100		Gobo Position X coarse	
	0-127	Movement forward	proportional
	128	Centre (128-default)	step
	129-255	Movement backward	proportional
101		Gobo position X fine	
	0-255	Position X fine	proportional

Appendix - DMX protocol

DMX Channel	DMX Value	Function	Type of control
102		Gobo position Y coarse	
	0-127	Movement down	proportional
	128	Centre (128-default)	step
	129-255	Movement up	proportional
103		Gobo position Y fine	
	0-255	Position Y fine	proportional
104		Gobo zoom X coarse	
	0-127	Narrowing	proportional
	128	Centre (128-default)	step
	129-255	Widening	proportional
105		Gobo zoom X fine	
	0-255	Zoom X fine	proportional
106		Gobo zoom Y coarse	
	0-127	Narrowing	proportional
	128	Centre (128-default)	step
	129-255	Widening	proportional
107		Gobo zoom Y fine	
	0-255	Zoom Y fine	proportional
108		Synchronization to ID	
	0	No function	step
	1-255	Synchronization to fixture ID	proportional
Gobo layer 3			
109		Dimmer	
	0-255	Dimmer intensity from 0% to 100% (255-default)	proportional
110		Gobo Folder selection	
	0-20	Factory folders	step
	21-240	User folders	step
	241-250	Reserved	
	251	Live input (grab. card)-see channel 111	step
	252	Straming from remote sources	step
	253-255	Reserved	
111		Gobo selection	
	0	White	step
	1-255	255 Gobos (one by one)	step
		<i>If Live input (251 DMX) is selected on channel 110:</i>	
	0	White screen	step
	1-20	Video composite input-PAL system	step
	21-40	SVIDEO input- PAL system	step
	21-60	Video composite input-NTSC system	step
	61-80	SVIDEO input- NTSC system	step
	81-100	Video composite input-SECAM system	step
	101-120	SVIDEO input- SECAM system	step
121-255	Reserved		
112		In Frame High	
	0-255	Defines the beginning of a media file segment as a percentage of the movie length (0-default)	proportional
113		In Frame Low	
	0-255	Defines the beginning of a media file segment as a percentage of the movie length (0-default)	proportional

Appendix - DMX protocol

DMX Channel	DMX Value	Function	Type of control
114		Out Frame High	
	0-255	Defines the end of a media file segment as a percentage of the movie length (255-default)	proportional
115		Out Frame Low	
	0-255	Defines the beginning of a media file segment as a percentage of the movie length (255-default)	proportional
116		Gobo control	
		<u>Copy mode</u>	
		<i>Video stream 1</i>	
	0	Play forward if dimmer (on layer 3) > 0, looping continuously	step
	1	Play forward if dimmer (on layer 3) > 0, hold on last frame	step
	2	Pause	step
	3	Play forward in continuous loop	step
	4	Play forward once and hold on the last frame	step
	5	No function	
	6	Scrub (Display) the selected In Frame	step
	7	Scrub (Display) the selected Out Frame	step
	8-9	Reserved	
		<i>Video stream 2 (the same functionality as for Video stream 1):</i>	
	10	Play forward if dimmer (on layer 3) > 0, looping continuously	step
	11	Play forward if dimmer (on layer 3) > 0, hold on last frame	step
	12	Pause	step
	13	Play forward in continuous loop	step
	14	Play forward once and hold on the last frame	step
	15	No function	
	16	Scrub (Display) the selected In Frame	step
	17	Scrub (Display) the selected Out Frame	step
	18-19	Reserved	
		<u>Addition mode</u>	
		<i>Video Stream 1</i>	
	20	Play forward if dimmer (on layer 3) > 0, looping continuously	step
	21	Play forward if dimmer (on layer 3) > 0, hold on last frame	step
	22	Pause	step
	23	Play forward in continuous loop	step
	24	Play forward once and hold on the last frame	step
	25	No function	
	26	Scrub (Display) the selected In Frame	step
	27	Scrub (Display) the selected Out Frame	step
	28-29	Reserved	
		<i>Video stream 2</i>	
	30-37	<i>the same functionality as for Video stream 1</i>	step
	38-39	Reserved	
		<u>Substraction mode</u>	
		<i>Video Stream 1</i>	
	40	Play forward if dimmer (on layer 3) > 0, looping continuously	step
	41	Play forward if dimmer (on layer 3) > 0, hold on last frame	step
	42	Pause	step
	43	Play forward in continuous loop	step
	44	Play forward once and hold on the last frame	step
	45	No function	

Appendix - DMX protocol

DMX Channel	DMX Value	Function	Type of control
116	46	Scrub (Display) the selected In Frame	step
	47	Scrub (Display) the selected Out Frame	step
	48-49	Reserved	
		<i>Video Stream 2</i>	
	50-57	<i>the same functionality as for Video stream 1</i>	step
	58-59	Reserved	
		<u>Multiplication mode</u>	
		<i>Video stream 1</i>	
	60	Play forward if dimmer (on layer 3) > 0, looping continuously	step
	61	Play forward if dimmer (on layer 3) > 0, hold on last frame	step
	62	Pause	step
	63	Play forward in continuous loop	step
	64	Play forward once and hold on the last frame	step
	65	No function	
	66	Scrub (Display) the selected In Frame	step
	67	Scrub (Display) the selected Out Frame	step
	68-69	Reserved	
		<i>Video Stream 2</i>	
	70-77	<i>the same functionality as for Video stream 1</i>	step
	78-79	Reserved	
		<u>Minimum mode</u>	
		<i>Video stream 1</i>	
	80	Play forward if dimmer (on layer 3) > 0, looping continuously	step
	81	Play forward if dimmer (on layer 3) > 0, hold on last frame	step
	82	Pause	step
	83	Play forward in continuous loop	step
	84	Play forward once and hold on the last frame	step
	85	No function	
	86	Scrub (Display) the selected In Frame	step
	87	Scrub (Display) the selected Out Frame	step
	88-89	Reserved	
		<i>Video Stream 2</i>	
	90-97	<i>the same functionality as for Video stream 1</i>	step
	98-99	Reserved	
		<u>Maximum mode</u>	
		<i>Video stream 1</i>	
	100	Play forward if dimmer (on layer 3) > 0, looping continuously	step
	101	Play forward if dimmer (on layer 3) > 0, hold on last frame	step
	102	Pause	step
	103	Play forward in continuous loop	step
104	Play forward once and hold on the last frame	step	
105	No function		
106	Scrub (Display) the selected In Frame	step	
107	Scrub (Display) the selected Out Frame	step	
108-109	Reserved		
	<i>Video Stream 2</i>		
110-117	<i>the same functionality as for Video stream 1</i>	step	
118-255	Reserved		
117		Playback Speed	
	0	Normal Speed	step

Appendix - DMX protocol

DMX Channel	DMX Value	Function	Type of control
	1-127	Slow speeds from slowest ---> normal	proportional
	128	Normal Speed	step
	129-255	Faster than Normal ---> Fastest	proportional
118		Gobo rotation and indexing	
	0-63	Clockwise rotation from fast to slow	proportional
	64-127	Indexing	proportional
	128	No rotation-centre (128-default)	step
	129-192	Indexing	proportional
	193-255	Anticlockwise rotation from slow to fast	proportional
119		Gobo fine indexing (rotation)	
	0-255	Fine indexing (rotation)	proportional
120		Gobo effect 1 Selection	
	0	No effect	
	1	Zoom sinus	P1-speed
	2	Zoom bump in fade out	P1-speed
	3	Zoom fade in bump out	P1-speed
	4	Reserved	
	5	Zoom in fade	P1-speed
	6	Zoom out fade	P1-speed
	7	Scale xy sinus	P1-speed
	8	Reserved	
	9	Reserved	
	10	Reserved	
	11	XY pos. circle counter-clockwise	P1-speed
	12	XY pos. circle clockwise	P1-speed
	13	XY pos. scroll up	P1-speed
	14	XY pos. scroll down	P1-speed
	15	XY pos. scroll left	P1-speed
	16	XY pos. scroll right	P1-speed
	17	Right-left diag. down scroll	P1-speed
	18	Right-left diag. up scroll	P1-speed
	19	Left-right diag. down scroll	P1-speed
	20	Left-right diag. up scroll	P1-speed
	21	X rotate	P1-speed
	22	Y rotate	P1-speed
	23	XY rotate	P1-speed
	24	XY inv. rotate	P1-speed
	25	X inv. y rotate	P1-speed
	26	Tile xy	P1-amount
	27	Tile xy	P1-speed
	28	XYZ rot. cube	P1-speed
	29	XYZ rot. sphere	P1-speed
	30	X rot. cylinder	P1-speed
	31	Y rot. cylinder	P1-speed
	32	Reserved	
	33	Kaleidoscope	none
	34	Squeeze in	none
	35	Squeeze out	none
36	Bend X	none	
37	Bend Y	none	

Appendix - DMX protocol

DMX Channel	DMX Value	Function	Type of control							
120	38	Tile frame	none							
	39	Frame	none							
	40	Plane Flip X	none							
	41	Plane Flip Y	none							
	42	Plane Flip XY	none							
	43	Plane mirror X top	none							
	44	Plane mirror X bottom	none							
	45	Plane mirror Y left	none							
	46	Plane mirror Y right	none							
	47	Plane mirror XY segment 1	<table border="1"> <tr><td>segment 1</td><td>segment 2</td></tr> <tr><td> </td><td> </td></tr> <tr><td>segment 4</td><td>segment 3</td></tr> </table>	segment 1	segment 2			segment 4	segment 3	none
	segment 1	segment 2								
	segment 4	segment 3								
	48	Plane mirror XY segment 2	none							
	49	Plane mirror XY segment 3	none							
	50	Plane mirror XY segment 4	none							
	51	Plane tile 2x	none							
	52	Plane tile 3x	none							
	53	Plane tile 4x	none							
	54	Plane tile 5x	none							
	55	Plane cross tile 2x	none							
	56	Plane cross tile 2x inverse	none							
	57	Plane cross tile 3x	none							
	58	Plane cross tile 3x inverse	none							
	59	Plane cross tile 4x	none							
	60	Plane cross tile 4x inverse	none							
	61	Plane cross tile 5x	none							
	62	Plane cross tile 5x inverse	none							
	63	Plane cross tiler 5x	none							
	64	Plane cross tiler 5x inverse	none							
	65	Plane bar	none							
	66	Plane bar inverse	none							
	67	Plane bar left-right	none							
	68	Plane bar top-bottom	none							
	69	Reserved								
	70	Reserved								
	71	Gobo disc	none							
	72	Gobo disc Flip X	none							
	73	Gobo disc Flip Y	none							
	74	Gobo disc Flip XY	none							
75	Gobo disc mirror X	none								
76	Gobo disc mirror Y	none								
77	Gobo disc mirror XY	none								
78-79	Reserved									
80	Plane mirror X top inverse	none								
81	Plane mirror X bottom inverse	none								
82	Plane mirror Y left inverse	none								
83	Plane mirror Y right inverse	none								
84	Plane mirror XY inverse	none								
85	Plane mirror X-inverse,Y	none								
86	Plane mirror X,Y-inverse	none								
87-89	Reserved									
90	Circular effect (Fish eye)	P1, P2, P3								

Appendix - DMX protocol

DMX Channel	DMX Value	Function	Type of control
		<i>P1-character, P2-X ratio, P3-Y ratio</i>	
	91-99	Reserved	
		<i>kaleidoscope - mode and mosaic segment selection:</i>	
	100	Square -static mode	P1,P2,P3
	101	Square -dynamic mode	P1,P2,P3
	102	Right triangular - static mode	P1,P2,P3
	103	Right triangular - dynamic mode	P1,P2,P3
	104	Isosceles triangular - static mode	P1,P2,P3
	105	Isosceles triangular - dynamic mode	P1,P2,P3
	106	Triangular 1 - static mode	P1,P2,P3
	107	Triangular 1 -dynamic mode	P1,P2,P3
	108	Triangular 2 -static mode	P1,P2,P3
	109	Triangular 2 - dynamic mode	P1,P2,P3
	110	Centered kaleidoscope (rough)-static mode	P1, P2, P3
	111	Centered kaleidoscope (rough)-dynamic mode	P1, P2, P3
	112	Centered kaleidoscope (fine)-static mode	P1, P2, P3
	113	Centered kaleidoscope (fine)-dynamic mode	P1, P2, P3
		<i>Stat. mode:P1-density, P2-content (coarse), P3-content (fine)</i>	
		<i>Dyn. mode:P1-density, P2-size and pulsation, P3-movement</i>	
	114-149	Reserved	
	150	Layer keystoneing	P1,P2,P3
		<i>P1-skewing in X, P2-skewing in Y, P3-squeezing/stretching in Y</i>	
	151-255	Reserved	
121		Gobo effect 1 - Parameter 1	
	0 - 255	Effect control	depends on effect
122		Gobo effect 1 - Parameter 2	
	0 - 255	Effect control	depends on effect
123		Gobo effect 1 - Parameter 3	
	0 - 255	Effect control	depends on effect
124		Gobo effect 2 Selection	
	0	No effect	
	1	Colour to black and white	P1-amount
	2	Colour to black and white inverse	P1-amount
	3	Black and white to black and white inverse	P1-amount
	4	Inversion	P1-amount
	5	Black Mask	P1-amount
	6	Black Mask inverse	P1-amount
	7	Contrast	P1-amount
	8	Brightness	P1-amount
124	9	RGB to GBR	P1-amount
	10	RGB to BRG	P1-amount
	11	RGB to RBG	P1-amount
	12	Black and white to black and white inverse timed	P1-speed
	13	Colour to black and white timed	P1-speed
	14	Colour to inverse timed	P1-speed
	15	Cycle	P1-speed
	16	Cycle inverse	P1-speed
	17	Reserved	
	18	Reserved	
	19	Colour Key	P1-amount

Appendix - DMX protocol

DMX Channel	DMX Value	Function	Type of control
	20	Colour Key inverse	P1-amount
	21	Key Black	P1-amount
	22	Key Black inverse	P1-amount
	23	Key White	P1-amount
	24	Key White inverse	P1-amount
	25	White flash	P1-amount
	26	Black flash	P1-amount
	27	Alpha flash	P1-amount
	28	Invert flash	P1-amount
	29	BW Flash	P1-amount
	30	Black and white to black and white inverse Flash	P1-amount
	31	Gradient Wipe X	P1-amount
	32	Gradient Wipe Y	P1-amount
	33-39	Reserved	
	40	Gaussian filter	P1-amount
	41	Mean filter	P1-amount
	42	Laplacian filter	P1-amount
	43	Emboss filter	P1-amount
	44	Sharpness filter	P1-amount
	45-49	Reserved	
		RGB effects:	
	50	RGB subtract All Pixels	P1, P2, P3
	51	RGB add All Pixels	P1, P2, P3
	52	RGB add non-black Pixels	P1, P2, P3
	53	RGB subtract/add All Pixels	P1, P2, P3
	54	Swap RGB to RBG	P1, P2, P3
	55	Swap RGB to GRB	P1, P2, P3
	56	Swap RGB to GBR	P1, P2, P3
	57	Swap RGB to BRG	P1, P2, P3
	58	Swap RGB to BGR	P1, P2, P3
	59	RGB invert	P1, P2, P3
	60	Invert and swap RGB to BRG	P1, P2, P3
	61	Invert and swap RGB to GBR	P1, P2, P3
	62	Colour to Alpha	P1, P2, P3
	63	Colour to Alpha inverted	P1, P2, P3
	64-67	Reserved	
	68	RGB scale <i>P1-red, P2-green, P3-blue</i>	P1, P2, P3
	69	Brightness scale <i>P1, P2 - inclination of conversion line</i>	P1, P2, P3
	70-149	Reserved	
	150	Layer keystoneing <i>P1-squeezing/stretching in X, P2/P3-compressing & expanding in X/Y</i>	P1,P2,P3
151-255	Reserved		
125		Gobo effect 2 -Parameter 1	
	0-255	Effect control	depends on effect
126		Gobo effect 2 -Parameter 2	
	0-255	Effect control	depends on effect
127		Gobo effect 2 -Parameter 3	
	0-255	Effect control	depends on effect

Appendix - DMX protocol

DMX Channel	DMX Value	Function	Type of control
128		Gobo Position X coarse	
	0-127	Movement forward	proportional
	128	Centre (128-default)	step
	129-255	Movement backward	proportional
129		Gobo position X fine	
	0-255	Position X fine	proportional
130		Gobo position Y coarse	
	0-127	Movement down	proportional
	128	Centre (128-default)	step
	129-255	Movement up	proportional
131		Gobo position Y fine	
	0-255	Position Y fine	proportional
132		Gobo zoom X coarse	
	0-127	Narrowing	proportional
	128	Centre (128-default)	step
	129-255	Widening	proportional
133		Gobo zoom X fine	
	0-255	Zoom X fine	proportional
134		Gobo zoom Y coarse	
	0-127	Narrowing	proportional
	128	Centre (128-default)	step
	129-255	Widening	proportional
135		Gobo zoom Y fine	
	0-255	Zoom Y fine	proportional
136		Synchronization to ID	
	0	No function	step
	1-255	Synchronization to fixture ID	proportional
* DMX value 10 and 11 changes meaning of channels 18-25.			
See chapter "Projection onto angular, cylindric or spheric surfaces" in the User manual.			