

ROBE

Digital Spot 7000^{DT}

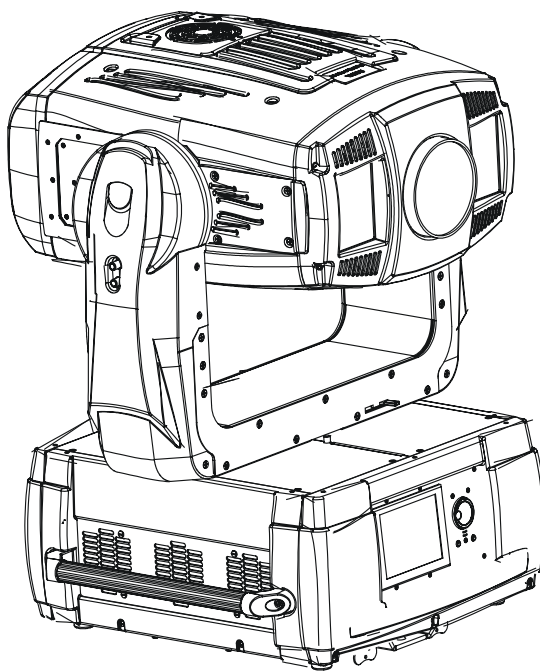

DT series

USER MANUAL

Version 1.3

Table of contents

1. Safety instructions	4
2. Unpacking	5
3. Introduction	6
4. Fixture exterior view	6
5. Video inputs	7
6. Connection to the mains	7
6.1 Powering on the DigitalSpot 7000 DT	7
6.2 “Power down” mode	7
7. Shutting down the DigitalSpot 7000 DT	7
8. Positioning the DigitalSpot 7000 DT	8
9. Rigging the fixture	9
10. DMX 512 connection	10
11. Ethernet connection	11
12. Folder organization	12
13. Control menu map	14
14. Operating modes	20
15. Control menu	20
15.1 Fixture Address	20
15.2 Fixture information	21
15.3 Personality	21
15.4 Lamp On/Off	23
15.5 Manual control	23
15.6 Stand-alone setting	23
15.7 Preview mode	25
15.8 Reset functions	25
15.9 Service menu	25
15.10 Special functions	26
15.11 Fixture Off	28
16. Keystones	28
16.1 Global keystone parameters	28
16.2 Layer keystone parameters	29
17. In Frame and Out Frame parameters	33
18. Video Control	33

19. Playback speed	34
20. Graphic effects.....	35
20.1 Kaleidoscopic effect.....	35
20.2 Circular effect (Fish eye)	37
20.3 RGB (CMY) effects.....	37
21. Media content management.....	42
21.1 Moving files between the fixture and PC	42
21.2 Moving files between networked fixtures.....	46
22. Remote control of the fixture via WWW browser	47
23. Picture merging	51
23.1 Picture merging control channels.....	51
23.2 Picture merging example.....	59
24. Pre-cut content mode for Picture Merging	59
25. Effect video synchronization	61
26. Projection onto angular, cylindric or spheric surfaces	62
26.1 Curved surface support channels	62
26.2 Rectangle onto circle (sphere) mapping with picture merging.....	64
27. Video processing on gobo layers from a streaming video server	65
28. RDM	70
29. Technical specifications	71
30. Error and information messages	76
31. Maintenance.....	77
31.1 Replacing the lamp	77
31.2 Replacing the projector	78
31.3 Accessing to the projector control buttons.....	79
31.4 Installing the DVI/VGA capture card.....	79
31.5 Installing the SDI/ASI capture card	80
31.6 Installing the optional optics	82
31.7 Replacing the fixture air filters	83
31.8 Replacing the filter cartridge in the projector.....	84
31.8.1 Ressetting the Filter Counter	84
31.8.2 Ressetting the Scroll Counter.....	85
31.9 Replacing the fuse	86
31.10 System restore.....	86
31.11 Cleaning	86

**FOR YOUR OWN SAFETY, PLEASE READ THIS USER MANUAL CAREFULLY
BEFORE POWERING OR INSTALLING YOUR DIGITALSPOT 7000 DT !
Save it for future reference.**

This device has left our premises in absolutely perfect condition. In order to maintain this condition and to ensure a safe operation, it is absolutely necessary for the user to follow the safety instructions and warning notes written in this manual.

The manufacturer will not accept liability for any resulting damages caused by the non-observance of this manual or any unauthorized modification to the device.

Please consider that damages caused by manual modifications to the device are not subject to warranty.

The DigitalSpot 7000 DT was designed for indoor use and it is intended for professional application only. It is not for household use.

1. Safety instructions

DANGEROUS VOLTAGE CONSTITUTING A RISK OF ELECTRIC SHOCK IS PRESENT WITHIN THIS UNIT!

Make sure that the available voltage is not higher than stated on the rear panel of the fixture. This fixture should be operated only from the type of power source indicated on the marking label. If you are not sure of the type of power supplied, consult your authorized distributor or local power company.

Always disconnect the fixture from AC power before cleaning, removing or installing the fuses, or any part.

Make sure that the power switch is set to off-position before you connect the fixture to the mains. The power plug has to be accessible after installing the fixture. Do not overload wall outlets and extension cords as this can result in fire or electric shock.

Do not allow anything to rest on the power cord. Do not locate this fixture where the cord may be damaged by persons walking on it.

Make sure that the power cord is never crimped or damaged by sharp edges. Check the fixture and the power cord from time to time.

Refer servicing to qualified service personnel.

This fixture falls under protection class I. Therefore this fixture has to be connected to a mains socket outlet with a protective earthing connection.

Do not look straight at the fixture objective lens or LED module during operation. The intense light beam may damage your eyes.

If the device has been exposed to drastic temperature fluctuation (e.g. after transportation), do not switch it on immediately. The arising condensation water might damage your device. Leave the device switched off until it has reached room temperature.

Do not shake the device. Avoid brute force when installing or operating the device.

DigitalSpot 7000 DT

This fixture was designed for indoor use only, Do not expose this unit to rain or use near water.

When choosing the installation spot, please make sure that the device is not exposed to extreme heat, moisture or dust.

Air vents and slots in the fixture's head and base are provided for ventilation, to ensure reliable operation of the device and to protect it from overheating.

The openings should never be covered with cloth or other materials, and never must be blocked.

This fixture should not be placed in a built-in installation unless proper ventilation is provided.

Always use a secondary safety cable when mounting this fixture.

Only operate the fixture after having checked that the housing is firmly closed and all screws are tightly fastened.

Make sure that the area below the installation place is blocked when rigging, derigging or servicing the fixture.

Do not block the front objective lens with any object when the fixture is under operation.

The lamp becomes extremely hot during operation. Allow the fixture to cool approximately 40 minutes prior to removing the lamp assembly for replacement. Do not operate lamps beyond the rated lamp life.

Operate the fixture only after having familiarized with its functions. Do not permit operation by persons not qualified for operating the fixture. Most damages are the result of unprofessional operation!

Please use the original packaging if the fixture is to be transported.

Please consider that unauthorized modifications on the fixture are forbidden due to safety reasons!

If this device will be operated in any way different to the one described in this manual, the product may suffer damages and the guarantee becomes void. Furthermore, any other operation may lead to dangers like short-circuit, burns, electric shock, lamp explosion, crash etc.

To switch the DigitalSpot 7000 DT off, always use either option "Fixture Off" in main menu or set a DMX value of channel 8 between 240-249.

Never switch the fixture off by pulling out the power plug from the socket otherwise the fixture may be damaged (projector lamp, operating system...)!

2. Unpacking

The DigitalSpot 7000 DT is packaged in either a cardboard box or one-unit (two-unit) flight case to protect the product during shipment.

The following items are included:

- the DigitalSpot 7000 DT
- 2 omega holders
- the USB 2.0 flash drive with a System recovery utility
- this user manual

3. Introduction

The DigitalSpot 7000 DT features moving head with a video projection and automated lighting technologies including a DMX controllable digital media server installed in a fixture's base. The built-in 32-bit Graphics Engine utilizes Linux and DirectX application programming interface to provide extensive image control of graphic objects. The Digital spot 7000 DT uses DMX512 protocol to control hardware functions like pan, tilt, and focus, as well as media fixture capabilities including loading images and movies. The graphics engine allows you manipulate position, scale, rotation, apply visual effects and colour mix each image.

S-Video and VGA inputs for direct input to data projectors are handy for performing presentations. S-Video and Composite live inputs can be used in graphics effects of DigitalSpot 7000 DT

4. Fixture exterior view

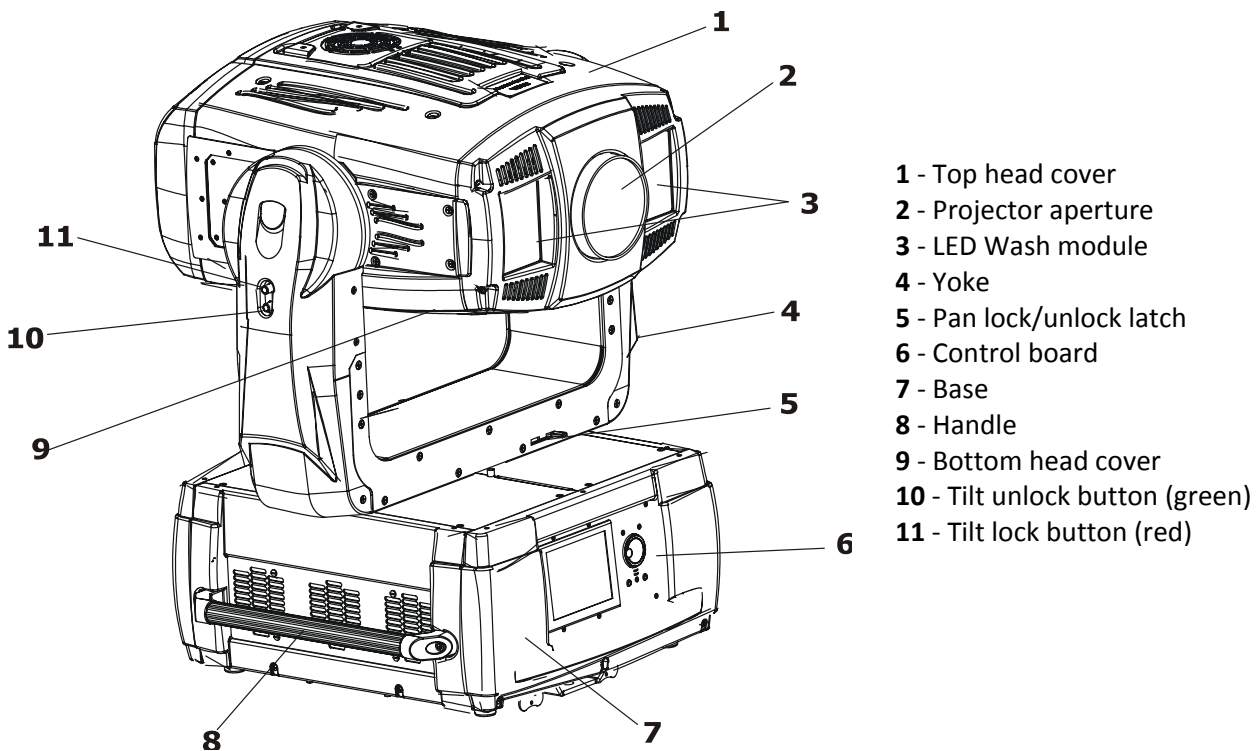

The fixture head is locked for transportation - the tilt lock button (11) is pushed and the pan lock/unlock latch (5) is in a lock position. To unlock the fixture head, press the tilt unlock button (9) and move the pan lock/unlock latch into an unlock position.

Front panel of fixture base

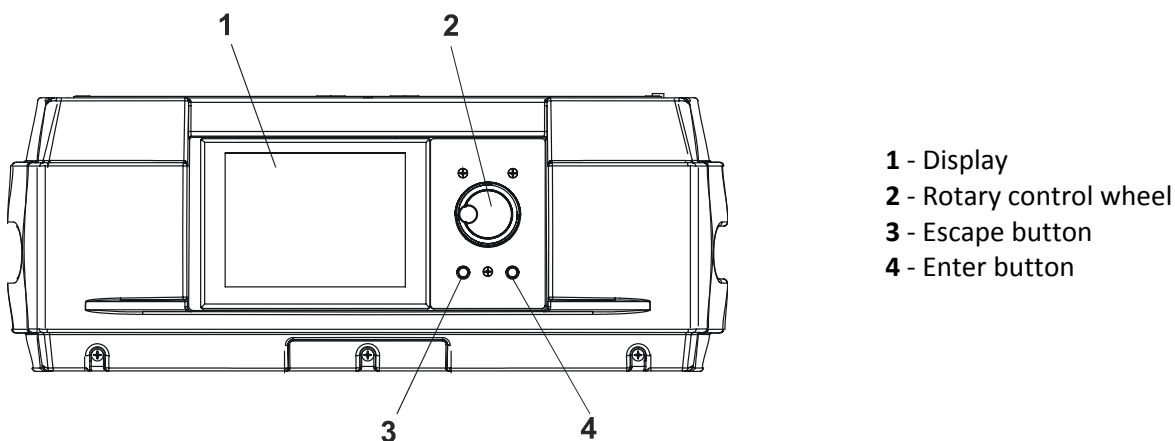

Rear panel of the fixture base

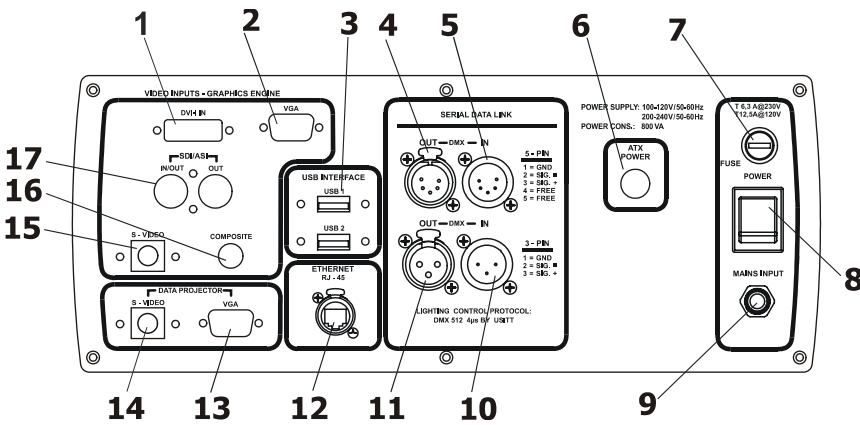

- 1 - DVI-I input (optional) - graph. engine
- 2 - VGA input (optional)- graph.engine
- 3 - 2x USB
- 4 - DMX output (5-pin XLR)
- 5 - DMX input (5-pin XLR)
- 6 - ATX switch
- 7 - Fuse holder
- 8 - Power switch
- 9 - Power cord
- 10 - DMX input (3-pin XLR)
- 11 - DMX output (3-pin XLR)
- 12 - LAN (RJ-45) port
- 13 - VGA input-dataprojector
- 14 - S-video input-dataprojector
- 15 - S-video input - graph. engine
- 16 - Composite input - graph. engine
- 17 - SDI/ASI (optional) inputs-graph.engine

5. Video inputs

Both **VGA** (13) and **S-Video** (14) inputs provide direct connection to the projector. The inputs are intended for a static presentation as data going through the inputs cannot be processed in a graphics engine ,it means that graphics effects from a DMX protocol will not be usable. In this use of the fixture, the function of Keystoning from a DMX protocol will not operate. Next both inputs **S-Video** (15) and **Composite** (16) enable to process data in a graphics engine, it is means that you can use all spectrum of effects that the DMX protocol offers.

6. Connection to the mains

Install a suitable plug on the power cord, note that the cores in the power cord are colored according to the following table.

Core (Eu)	Core (US)	Pin	Symbol
Brown	Black	Live	L
Light blue	White	Neutral	N
Yellow/Green	Green	Earth	

The earth has to be connected!

6.1 Powering on the DigitalSpot 7000 DT

When the fixture is connected to the AC mains supply and the power switch is on, it automatically begins a homing procedure to verify that all functions of the fixture and its internal projector are in good order.

6.2 "Power down" mode

This mode omits fixture reset after switching the fixture on and deactivates all motors. The "Power down mode" is useful in special events e. g. if the fixture is placed in a flight case and you want to set its DMX address without taking it out from the case.To enter the "Power down mode",press and hold the [ENTER] button and at the same time switch on the Power switch. Press the [ESC] button to see a notice "Power Down Mode."

Now you can use the fixture menu to set desired behaviour of the unit. If you want to go to the standard operation mode without switching the fixture off, run total reset of the fixture (menu item **Reset all Systems**).

7. Shutting down the DigitalSpot 7000 DT

There are two recommended ways how to shutdown the fixture:

DigitalSpot 7000 DT

1. A DMX controller can switch off the projector lamp and shut down the fixture with the "Lamp Off, Fixture Off" option on the control channel 8 (see DMX protocol).
2. The option "Fixture Off" in main menu of DigitalSpot 7000 DT switches off the projector's lamp and shuts down the fixture.

After shutting down the fixture switch the power switch on the rear side of the fixture base to the off position in order to save energy.

**Removing power directly without the shutdown procedure
can reduce fixture reliability!**

8. Positioning the DigitalSpot 7000 DT

The DigitalSpot 7000 DT is designed to be installed in one of four possible installation locations:

1. Front Table - the fixture is placed near the floor in front of the screen.
2. Front Ceiling - the fixture is suspended upside-down from the ceiling (truss) in front of the screen.
Set Ceiling Projection in the menu Personality ("Personality--->"Projection Presetting"
--->"Ceiling Projection"--->"On")
3. Rear Table - the fixture is placed near the floor behind the screen. Set Rear Projection in the menu Personality ("Personality--->"Projection Presetting"--->"Rear Projection"--->"On")
Note that a special rear projection screen is required.
4. Rear Ceiling - the fixture is suspended upside-down from the ceiling (truss) behind the screen.
Set Rear Projection in the menu Personality ("Personality--->"Projection Presetting"--->"Rear Projection"--->"On") and Ceiling Projection ("Personality--->"Projection Presetting"
--->"Ceiling Projection"--->"On")
Note that a special rear projection screen is required.

When determining the position of the fixture and projection screen, you will need to account for the projected image size, which is directly proportional to the projection distance. There is a chart of 4:3 aspect-ratio screen sizes with a throw distance ratio of 1.8-2.4 : 1 to assist you in determining the ideal location for your fixture.

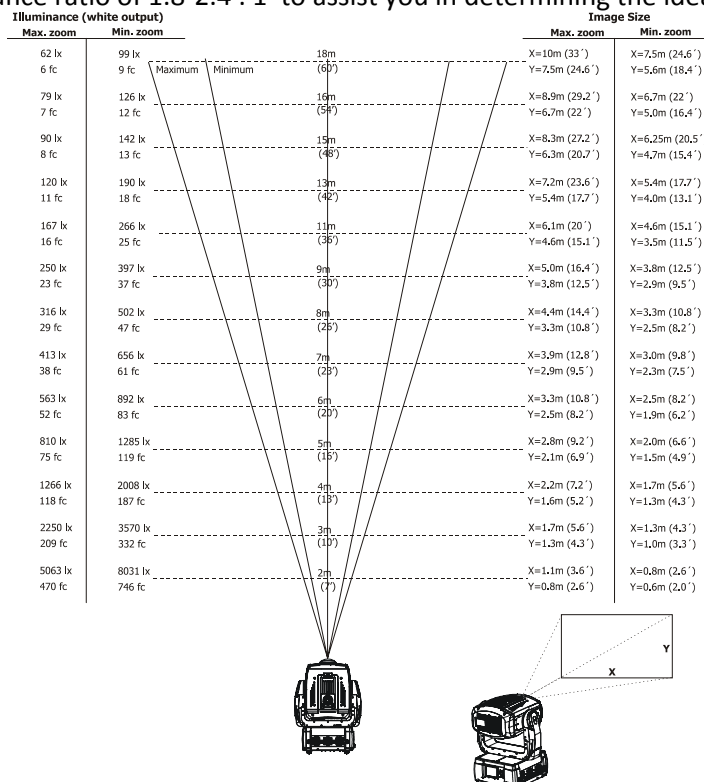

Note: There is a tolerance among these numbers due to optical component variations. We recommend that if you intend to permanently install the DigitalSpot 7000 DT, you should physically test the projection size and distance using the actual fixture in m before you permanently install it, so as to make allowance for this projector's optical characteristics. This will help you determine the exact mounting position so that it best suits your installation location

9. Rigging the fixture

Please consider the respective national norms during the installation!

Verify the truss or support will handle the combined weight of all the fixtures on the truss

Always use a secondary safety cable when mounting this fixture

When rigging, derigging or servicing the fixture staying in the area below the installation place, on bridges, under high working places and other endangered areas is forbidden.

The operator has to make sure that safety-relating and machine-technical installations are approved by an expert before taking into operation for the first time and after changes before taking into operation another time.

The operator has to make sure that safety-relating and machine-technical installations are approved by a skilled person once a year.

To ensure reliable operation of the product and to protect it from overheating, the vents must not be blocked or covered.

Hot air is exhausted from the exhaust vent. Do not put any flammable object near the fixture, hot air is exhausted from the air vents.

Keep the exhaust vents at least 1 m away from any objects.

Do not touch peripheral parts of the exhaust vent, especially screws, grids and metallic parts. These areas will become hot while the fixture is being used.

Do not put anything on the fixture. Objects put on the fixture will not only get damaged but also may cause fire hazard by heat.

Allow the fixture to cool for 20 minutes before handling.

The fixture should be installed out of the reach of people.

We recommend avoiding dusty/smoky environments when operating the fixture. Usage in these environments may cause a poor image quality. When using the fixture under dusty or smoky conditions, dust may accumulate on a lens, liquid crystal panels, or optical elements inside the projector. Such condition may degrade the quality of the projected image.

Overhead rigging requires extensive experience, including calculation of working load limits, installation material being used, and periodic safety inspection of all installation material and the fixture. If you lack these qualifications, do not attempt the installation yourself, but instead use a professional structural rigger. Improper installation can result in bodily injury and or damage to property.

The fixture must never be fixed swinging freely in the room.

Use 2 appropriate clamps to rig the fixture on a truss.

***Make sure that the device is fixed properly!
Ensure that the structure (truss) to which you are attaching
the fixtures is secure.***

For overhead use, always install a safety cable that can hold at least 10 times the weight of the fixture. You must only use safety cables with screw-on carabines. Pull the safety cable through the two apertures on the bottom of the base and over the trussing system etc. Insert the end in the carbine and tighten the fixation screw.

A pair of the Omega holders can be placed in 4 positions on the bottom of the base. Use 2 clamps (not supplied) with screws M12.

DigitalSpot 7000 DT

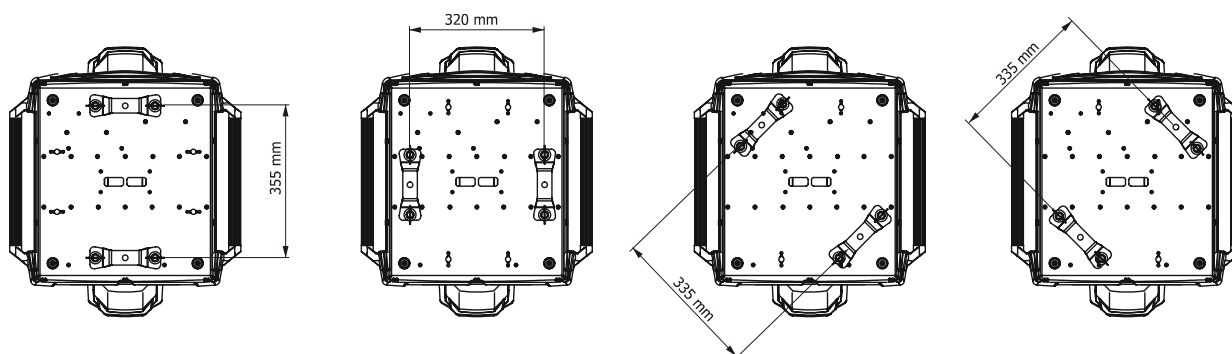

To install the fixture on the truss:

1. Bolt clamp (1) to the omega holder (2) with M12 bolt and lock nut through the hole in the holder.
2. Fasten the omega holders on the bottom of the base by inserting both quick-lock fasteners (3) into the holes of the base and tighten fully clockwise.
3. Fasten the safety-rope (4) through the two apertures in the bottom of the base and over the trussing system.

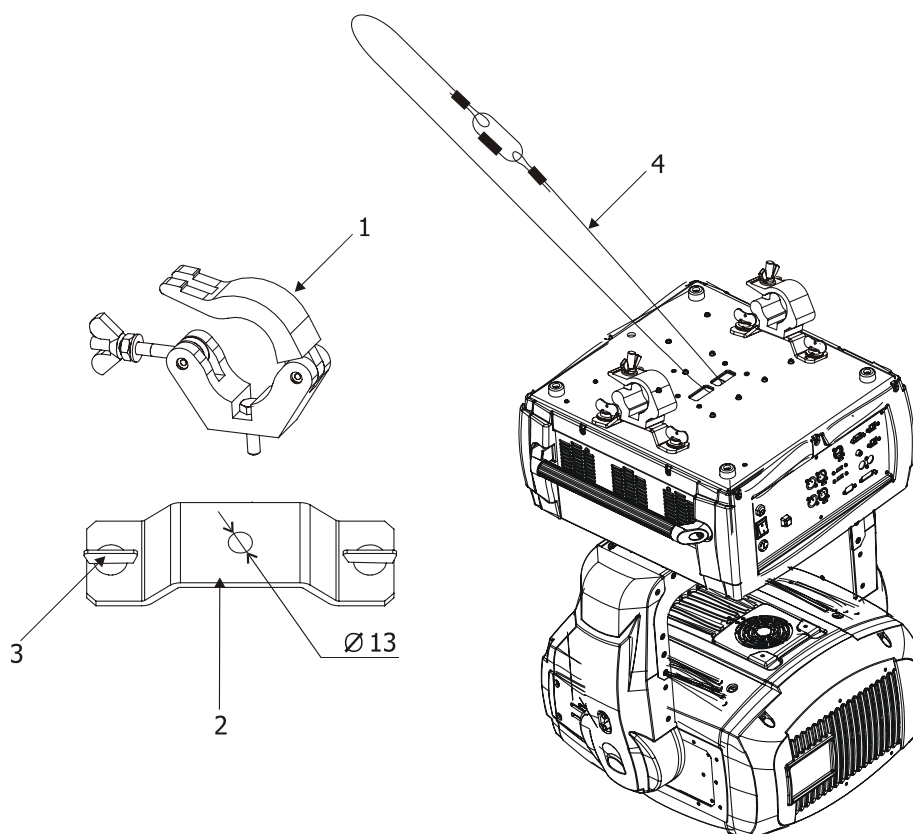

***Before taking into operation for the first time,
the installation has to be approved by an expert!***

10. DMX 512 connection

The fixture is equipped with both 3-pin and 5-pin XLR sockets for DMX input and output. Only use a shielded twisted-pair cable designed for RS-485 and 3-pin/5-pin XLR-connectors in order to connect the controller with the fixture or one fixture with another.

DigitalSpot 7000 DT

Wiring of the XLR connectors:

DMX output
XLR mounting sockets (rear view):

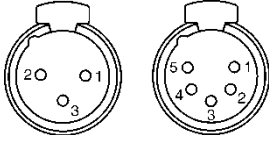

1 – Shield 2 - Signal (-) 3 - Signal (+) 4 – Not connected 5 – Not connected

DMX input
XLR mounting plugs (rear view):

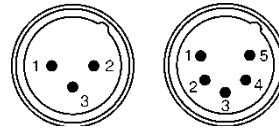

To build a DMX chain

1. Connect the DMX output of the first fixture in the DMX chain with the DMX input of the next fixture. Always connect one output with the input of the next fixture until all fixtures are connected.
2. Use menu "DMX Settings " to set the DMX start address on all fixtures (see the "Fixture address" menu).
3. The option Activate DMX mode has to be confirmed in the "DMX Settings" menu on all fixtures.
Do not overload the link. Max. 32 fixtures may be connected on a DMX link.

Example:

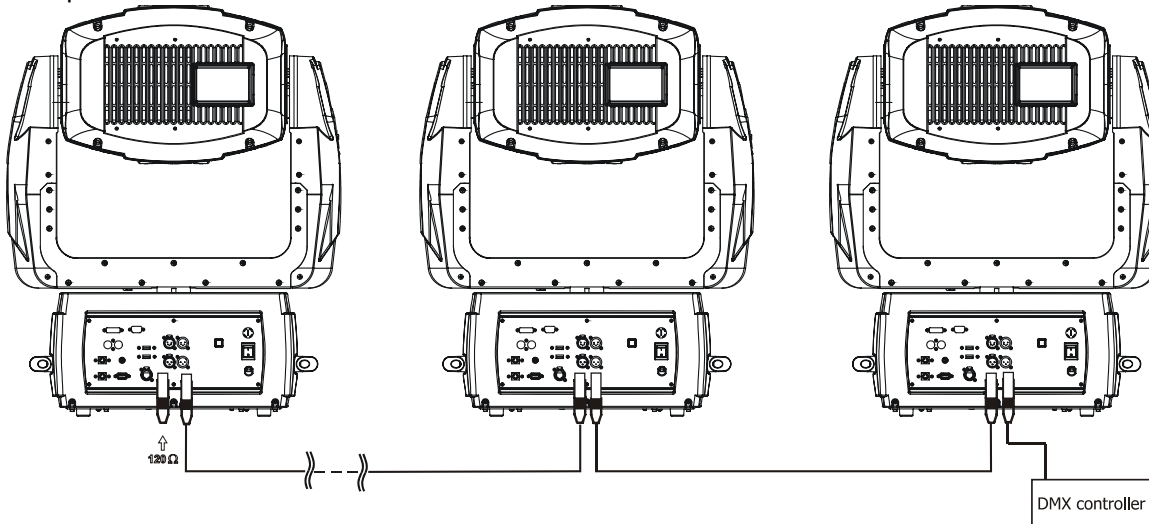

Caution: Terminate the link by installing a termination plug in the DMX output of the last fixture. The termination plug is a male 3-pin XLR plug with a 120 Ohm resistor soldered between Signal (-) and Signal (+).

11. Ethernet connection

The fixtures on a data link are connected to the Ethernet network with an Art-Net communication protocol. The controlling software from PC (or lighting console) has to support the Art-Net protocol.

The Art-Net communication protocol is a 10 Base T Ethernet protocol based on the TCP/IP. Its purpose is to allow transfer of large amounts of DMX 512 data over a wide area using standard network technology.

IP address is the Internet protocol address. The IP uniquely identifies any node (fixture) on a network.

The Universe is a single DMX 512 frame of 512 channels.

The DigitalSpot 7000 DT is equipped with 8-pin RJ-45 socket for Ethernet input. Use a network cable category 5 (with four "twisted" wire pairs) and standard RJ-45 plugs in order to connect the fixture to the network.

RJ-45 socket (front view):

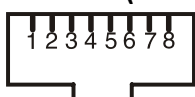

1- TD+
2- TD-

5- Not connected

6- RX-

11

RJ-45 plug (front view):

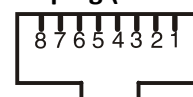

DigitalSpot 7000 DT

3- RX+ 7- Not connected
4- Not connected 8- Not connected

Patch cables that connect fixtures to the hubs or LAN sockets are wired 1:1, that is, pins with the same numbers are connected together:

1-1	2-2	3-3	4-4	5-5	6-6	7-7	8-8
-----	-----	-----	-----	-----	-----	-----	-----

If only the fixture and the computer are to be interconnected, no hubs or other active components are needed. A cross-cable has to be used:

1-3	2-6	3-1	4-8	5-7	6-2	7-5	8-4
-----	-----	-----	-----	-----	-----	-----	-----

Ethernet operation.

Connect the Ethernet inputs of all fixtures in the fixture chain with the network.

Use the menu "Artnet Settings " to set an IP address , artnet universe and artnet subnet on all fixtures (see the "Fixture address" menu).

The option "Activate Artnet mode" has to be confirmed in "Artnet Settings " menu on all fixtures.

Example:

(DMX address=1)

DMX address=1

IP address=002.168.002.004

Artnet Universe=2

Artnet Subnet=0

DMX address=170

IP address=002.168.002.003

Artnet Universe=1

Artnet Subnet=0

DMX address=1

IP address=002.168.002.002

Artnet Universe=1

Artnet Subnet=0

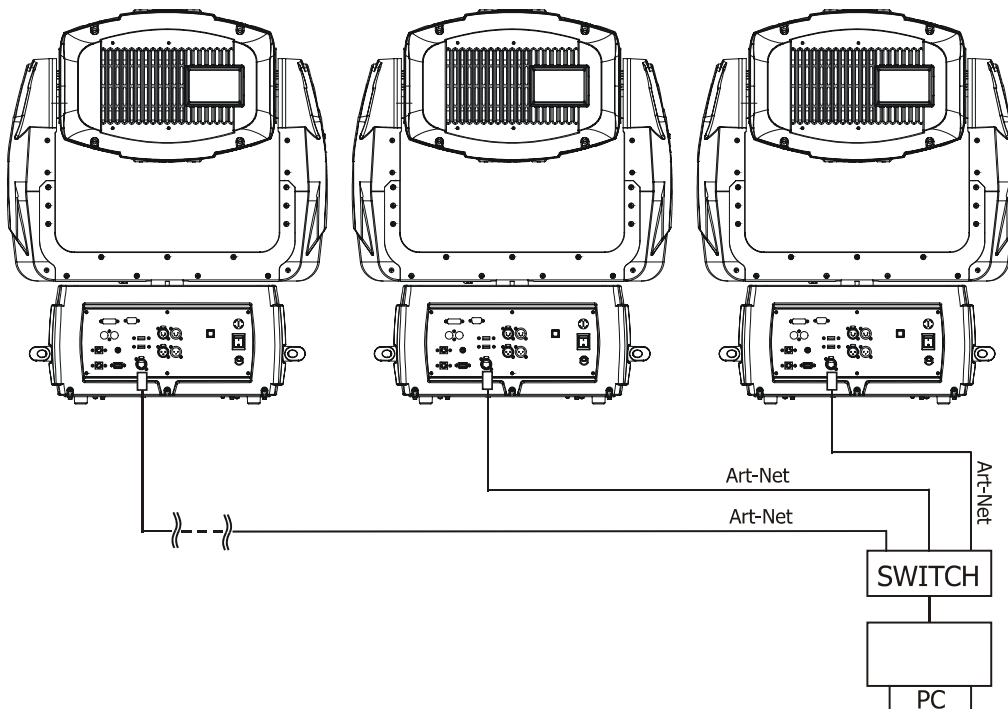

12. Folder organization

The library structure is reflected on the hard drive where all files for the library are stored. The whole library is contained within a special folder called 'Media'.

Inside the Media folder is a collection of folders (000,001...240) each named with a 3-digit number. Each folder following this convention represents a library folder and the 3-digit number represents the name of the folder. Because of this, you can't have folders without the 3 digit number scheme. You can't neither have two folders with the same digits.

Inside each folder is a collection of media files that the library folder holds. The media files also should follow the 3-digit conventions where a 3-digit number is followed by an underscore and a name e.g.: 001_testfile1.png. Note that for media files the digit starts at 001_ since visual 0 is always considered as being empty. The media files assigned to the DMX values can be sorted either in an **alphabetical** or **numerical order**. Default assigning is the alphabetical order. If you need to change this sorting, go to the menu "Personality" and select "Gobo selection mode" option.

The numerical order is suitable in the case that you need to exactly assign certain media files to specified DMX addresses.

The table below show differences in file→DMX assignment between the alphabetical and numerical sorting. The table also includes file names without a correct 3-digit convention to illustrate their behaviour in the numerical sorting.

Media file name	DMX value at Alphabetical Sorting	DMX value at Numerical Sorting
001_testfile1.png	1	1
020_testfile2.png	2	20
19_testfile3.png	3	19
3_testfile4.png	4	3
460_testfile5.png	5	Not Assigned*
testfile6.png	6	Not Assigned**

* The 3-digit number has to be in range of 001-255. If there is more than 255 media files in the folder, files above 255 are ignored.

** The media file name does not contain any digit.

Subfolders 000-020 are reserved for default gobos and videos (from factory) and their content cannot be changed.

The images and video clips can be in one of the following formats: bmp, jpg, tga; .png, gif, pcx, pnm, xpm and lbm for images and mpeg1, mpeg2 for videos.

The folder "**Programs**" serves for saving recorded DMX programs (dprg_01.csv,.....dprg_10.csv).

The folder named "**Update**" contains subfolders with the update files. The subfolders are created automatically during software updating and their names matching to date when software update has been executed.

The folder a "**Log**" serves for saving log files generate by the option "Generate Log File" in a menu "Special Functions" of the control panel. Log file names are deducated from the date when the file has been logged out.

Top level folder

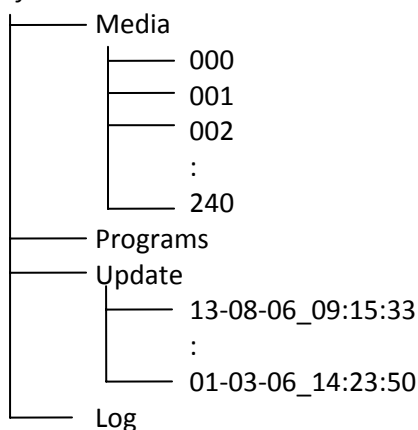

13. Control menu map

Default settings=Bold print

Menu Level 1	Menu Level 2	Menu Level 3	Menu Level 4	Menu Level 5	Menu Level 6	Menu Level 7	Menu Level 8	
Fixture Address	DMX Settings	Set DMX Address	001-512					
		Activate DMX Mode						
	Ethernet Settings	Set IP Address	Default IP Address					
			Custom IP Address					
			Set ArtNet Universe	0-15				
			Set ArtNet Subnet	0-15				
			Activate Artnet Mode					
	Fixture Information	DMX Values	Pan	0-255				
:								
Synchro to L4			0-255					
Media Disk Space Usage		Free Disk Space						
		Used Disk Space						
Software Version		Graphic Engine						
		IC1 Motherboard						
		IC2 Motherboard						
		IC3 Motherboard						
		IC1 HeadBoard						
GPU Info:		GPU						
		Video Bios						
		Driver Version						
		Display Device						
Product IDs		Mac Addr.						
		RDM UID						
Personality		Pan Reverse	On, Off					
	Tilt Reverse	On, Off						
	Analog Iris Reverse	On, Off						
	Lamp Presetting	Lamp On/Power On	On, Off					

DigitalSpot 7000 DT

Menu Level 1	Menu Level 2	Menu Level 3	Menu Level 4	Menu Level 5	Menu Level 6	Menu Level 7	Menu Level 8
		Lamp Off via DMX	On, Off				
		Lamp On If DMX is Present	On, Off				
		Lamp Off if not DMX	On, Off				
	Display Adjusting	Display Permanent On					
			Display Off After 5 min				
			Permanent On				
		Display Orientation	Normal Orientation				
			Rotated Orientation				
	Pan/Tilt Feedback	On, Off					
	Pan/Tilt Mode	Time Mode					
		Speed Mode					
	Active Blackout While:	During Movement Cor.	On, Off				
		Pan/Tilt Moving	On, Off				
	Projection Presetting	Ceiling Projection	On, Off				
		Rear Projection	On, Off				
		Throw Optics Mode	Not Installed				
			Long Throw Optics				
			Short Throw Optics				
		Projector Refresh Rate	60Hz (Default)				
			50Hz				
	Dmx Protocol	Set DMX Mode	No Server				
			2 Layers				
			3 Layers				
			4 Layers				
		Protocol Version	Version 1.1				
			:				
			Version 1.4				
	Gobo Selection Mode	Alphabetical Order					
		Numerical Order					
	Microphone Sensitivity	1..10..20					

DigitalSpot 7000 DT

Menu Level 1	Menu Level 2	Menu Level 3	Menu Level 4	Menu Level 5	Menu Level 6	Menu Level 7	Menu Level 8
	Default Settings	Set Default Values					
		Remove User Media Content					
Lamp On/Off	On, Off						
Manual Control	Manual DMX Control	Pan	0-255				
		:					
		Synchro to L4	0-255				
	Video Input Selection	Internal Input					
		External Composite Input					
		External SVideo Input					
	Dataprojector Control						
Stand-alone Setting	Play Program	Test program In Loop	Normal				
		Program 1 in Loop	Static	Pan	0-255		
		:		Tilt	0-255		
				Zoom	0 - 255		
		Program 10 in Loop		Focus	0-255		
				Run Program			
	Edit Program	Program 1					
		:	Edit Steps	Step 1	Pan		
		Program 10		:	:		
				Step 99	Synchroo To L4		
					Step Time	0.1-25.5	
					Fade Time	0.1-25.5	
					Snap DMX		
					Save		
			Start Step	1-99	Save and Copy		
			End Step	1-99			
	Music Trigger	On, Off					
	Play DMX Program	DMX Program 1 in Loop					
		:					

DigitalSpot 7000 DT

Menu Level 1	Menu Level 2	Menu Level 3	Menu Level 4	Menu Level 5	Menu Level 6	Menu Level 7	Menu Level 8
		DMX Program 10 in Loop					
	Record DMX Program	DMX Program 1					
		:					
		DMX Program 10					
	Preset Playback	Deactivated					
		:					
		DMX Program 10 in Loop					
	Fixture Off Timer	Timer Deactivated					
		Timer Activated					
		Set Timer Hours					
		Set Timer Minutes					
Preview Mode							
Reset Functions	Reset Graphics Engine						
	Reset Pan/Tilt System						
	Reset Zoom/Focus System						
	Reset Iris system						
	Reset All Systems						
Service Menu	Power On Time	Total Hours					
		Resettable Hours					
	Lamp On Time	Total Hours					
		Resettable Hours					
	Lamp Strikes	Total Strikes					
		Resettable Strikes					
	Fixture Temperatures	Current	Projector temp. 1				
			Projector temp. 2				
			Projector temp. 3				
			Pan/Tilt Board				

DigitalSpot 7000 DT

Menu Level 1	Menu Level 2	Menu Level 3	Menu Level 4	Menu Level 5	Menu Level 6	Menu Level 7	Menu Level 8
			LED Panel Board 1				
			LED Panel Board 2				
		Maximum Nonresetable	Projector temp. 1				
			Projector temp. 2				
			Projector temp. 3				
			Pan/Tilt Board				
			LED Panel Board 1				
			LED Panel Board 2				
		Maximum Resetable	Projector temp. 1				
			Projector temp. 2				
			Projector temp. 3				
			Pan/Tilt Board				
			LED Panel Board 1				
			LED Panel Board 2				
	Air Filters	Time To Clean Up Filters					
		Set clean Up Timer	10..50..300				
	Dataprojector Services	Filter Used Time					
		Remaining Filter Scrolls					
		Air Pressure Sensor					
Special Functions							
	Regenerate Thumbnails	Set Thumbnail size	50..96...300				
		Regenerate Thumbnails					
	FTP Server	Set Account					
		Allow Anonymous	Yes/No				
	HTTP Access	Set Account					
		Allow Anonymous	Yes/No				
	USB Data Synchronize	USB1	Open	Media	Open	000	Open
		USB2				:	Synchronize to Fixture
						240	Synchronize from Fixture

DigitalSpot 7000 DT

Menu Level 1	Menu Level 2	Menu Level 3	Menu Level 4	Menu Level 5	Menu Level 6	Menu Level 7	Menu Level 8
					Synchronize to Fixture		
					Synchronize from Fixture		
				Update	Open		
					Synchronize to Fixture		
					Synchronize from Fixture		
			Init Flash Disc				
	Software Update	Update Graphical Software					
		Update HW processors Software					
		Update Media Content					
	Calibrate Values	Analog Iris Calib.	0-255				
	Generate Log File						
	Remote Servis	Set Service IP Address	Remote IP Address	077.048.000.224			
			Remote Port	08283			
			Service Port	08290			
		Set Default Gateway	Gateway Address	002.001.001.001			
		Start Remote Service					
Fixture Off							

14. Operating modes

Before operating the DigitalSpot 7000 DT from a DMX 512 controller, you need to define the source of DMX data, which may be:

DMX 512 - data is transmitted over standard DMX cables. Set a valid DMX start address, which is defined as the first channel from which the DigitalSpot 7000 DT will respond to the controller.

Please, be sure that you don't have any overlapping channels in order to control each DigitalSpot 7000 DT correctly and independently from any other fixture on the DMX data link.

For DMX start address setting, please refer to the instructions under "Fixture Address".

ArtNet - data is transmitted over Ethernet network using ArtNet protocol. Set an IP address, ArtNet Universe and ArtNet Subnet.

For ArtNet setting, please refer to the instructions under "Fixture Address".

15. Control menu

The control panel situated on the front panel of the base offers several features. You can simply set the fixture addresses, configure the fixture, run test, make a reset and also use many functions for setting fixture behaviour.

Control elements on the control board:

[RNS] encoder wheel-moves between menu items on the same level, scrolls between values.

[ESC] button-leaves menu without saving changes

[ENTER] button-enters menu, confirms adjusted values and leaves menu

**After switching the fixture on,
the display shows the initial screen:**



**than press [ENTER] and
the display shows address:**

ARTNET MODE	
IP Address:	Fixture ID:
	2.1.1.50
ArtNet Universe:	0
ArtNet Subnet:	0
DMX Address:	001

The main menu of the control panel is accessed by pressing the [ENTER] button. To browse through the menu, rotate the [RNS] wheel. To select a function or submenu, press the [ENTER] button.

15.1 Fixture Address

Use this menu to set the DMX address.

DMX Setting --- Select this submenu to set the DMX start address.

Set DMX Address - sets DMX address. After selecting desired DMX address confirm setting by using the function "Activate DMX Mode":

Activate DMX Mode - Data is received from DMX input.

ArtNet Setting --- Select this submenu to set the fixture for Ethernet operating.

Set IP Address - Select this submenu to set an IP address and NetMask.

The IP address is the Internet protocol address and uniquely identifies any node (fixture) on a network. There can't be 2 fixtures with the same IP address on the network!

Default IP Address -Preset IP address.

Custom IP Address - The option enables edit all numbers of the IP address.

To set the custom IP address:

1. Select „Custom IP Address” and press the [ENTER].
2. Use RNS wheel to set the first number of the IP address

3. Press the [ENTER] to move on the second number of the IP address
 4. Repeat steps 2 and 3 for the third and fourth number of the IP address.
- If you want to return back on the previously edited number, press [ESC].
The same way you can set the Netmask Address.

Set ArtNet Universe - Select this submenu to set a Universe (0-15).
The Universe is a single DMX 512 frame of 512 channels.

Set ArtNet Subnet - Select the option to set Ethernet subnetworks to which the fixture belongs (0-15)
After setting all Artnet parameters confirm setting by using the function "Activate Artnet Mode":

Activate Artnet Mode - Data is received from the Ethernet input.

15.2 Fixture information

DMX Values --- Select this item to read DMX values of each channel received by the fixture.

Media Disk Space Usage --- Select the item to read information about the hard disk space.

Free Disk Space --- Select the item to show a size of free hard disk space (MB).

Used Disk Space --- Select the item to show a size of used hard disk space (MB).

Software Version --- Select this function to read the software version of the fixture modules:

Graphic Engine - a graphic software of the fixture.

IC1 Motherboard - a processor IC1 on the main board in the fixture base (the IC1 controls communication, DMX, fans, temperatures).

IC2 Motherboard - a virtual EEPROM.

IC3 Motherboard - a processor IC3 on the main board in the fixture base (the IC3 controls Pan and tilt).

IC1 Headboard - a processor IC1 in the fixture head (the IC1 controls zoom, focus, iris and LEDs).

GPU Info --- Select the item to read information about graphics processing unit, drivers and type of projector.

Product IDs --- Select the function to read the MAC address and the RDM UID code.

15.3 Personality

Use this menu to modify DigitalSpot 7000 DT operating behaviour.

Pan Reverse --- Select this function to invert the pan movement.

Tilt Reverse --- Select this function to invert the tilt movement.

Analog Iris Reverse --- Select this function to invert the mechanical iris movement.

Lamp Presetting --- Select this menu to change the lamp "behaviour".

Lamp On/Power On - Select this function to turn the projector's lamp on automatically after switching the fixture on.

Lamp Off via DMX - Select this function to switch the lamp off via DMX.

Lamp On if DMX Present - This function allows you to strike the lamp automatically after 26 seconds if a DMX signal is present on the data link.

Lamp Off if not DMX - This function allows you to switch off the lamp automatically after 2 minutes if a DMX signal is missing on the data link.

Display Adjusting --- This function allows you to change the display settings:

Display Permanent On - This function allows you to keep the display permanent on or to turn it off after 5 minutes of inactivity of control buttons (wheel)

Display Orientation - Select this function to adjust the display orientation:

Normal orientation - A standard display orientation.

Rotated Orientation - Inverts the display by 180°.

Pan/Tilt Feedback --- This function allows to return the moving head to the required pan/tilt position after changing the position by an external force (e.g. by a stroke).

Be careful, the Pan/Tilt Feedback OFF is not the standard operation and the head of the fixture can be damaged!

Note: If the feedback was switched off, the pan/tilt position is changed by an external force and the feedback is switched on again, the moving head might not to be synchronized with the DMX signal. You have to make a reset in order to synchronize the moving head with the DMX signal.

Pan/Tilt mode --- Use this menu to set the character of the pan/tilt movement.

Time mode --- Pan and tilt will move with different speeds and they will come at the same time to the end point (pan and tilt sets its optimal speed).

Speed Mode --- Pan and tilt will move with the same speed as adjusted by the channel 5. (Pan/Tilt speed). E.g. pan will come to the end point and wait for tilt, which has longer track.

Active Blackout while: --- Use this function if you wish to close the light output during the following events:

During Movement correction --- Select this function to enable the blackout during the head movement correction (if the moving head lost its right pan/tilt position for a short moment).

Pan/Tilt Moving --- This function closes the light output during pan/tilt changing.

Projection Presetting --- Use this menu depending on the installation location of the fixture:

Ceiling Projection --- When this function is "On", a picture is top (bottom and left) right reversed. This function enables to project the image from a ceiling mounting of the DigitalSpot 7000 DT.

Rear projection --- When this function is "On", picture is left (right) reversed. This function enables to project the image to a rear projection screen.

Throw Optics mode --- Use this menu if an optional optics has been installed in the fixture.

Not installed – the option has to be selected if the fixture is equipped with the standard optics (throw distance ratio 1.8 – 2.4:1).

Long Throw Optics – the options has to be selected if the optional long throw optics (throw distance ratio 2.7 – 3.5: 1) has been installed.

Short Throw Optics – the options has to be selected if the optional short throw optics (throw distance ratio 1.2 – 1.7: 1) has been installed.

Projector Refresh Rate --- Use this menu to change the output refresh rate of the DigitalSpot's projector from 60Hz to 50 Hz.

The function should be used in cases when output of the DigitalSpot 7000DT is captured by the video cameras with a fixed 50Hz refresh rate and they are not allowed to adjust embedded 60Hz picture refresh rate of the DigitalSpot, in these cases some flickering would be visible in an image.

Note. All fixtures used in a show must have the same projector refresh rate setting.

DMX protocol --- Use this menu to set desired number of gobo/video layers and DMX channels.

Set DMX mode --- the item allow you to select a desired number of control channels

No Server - the fixture uses first 22 control channels of DMX chart (1-22).

2 Layers - 113 control channels (1-113).

3 Layers - 141 control channels (1-141).

4 Layers - 169 control channels (1-169)

Protocol Version --- the item allow you to select a desired protocol version.

Gobo Selection Mode --- Use this menu to select desired sorting of media files in media subfolders.

Alphabetical Order --- The media files are assigned to DMX values in an alphabetical order.

Numerical projection --- The media files are assigned to DMX values in a numerical order.

Microphone Sensitivity --- Select this item to adjust the microphone sensitivity from 1 (maximum) to 20 (minimum).

Default Settings --- Select this option to set default values or to remove user's content in the fixture.

Set Default Values --- Select this option to reset all fixture personalities to the default values.

Remove User Media Content --- The item deletes all user media contents except the factory media content.

15.4 Lamp On/Off

Use this option in order to switch on/off the projector's lamp. Do not use the projector continuously for 24 hours or more. If using the projector continuously for long periods, turn it off and leave it for one hour at least once during a 24 hour period.

15.5 Manual control

Manual DMX control --- Select this menu to control all channels by the control elements on the control board.

Video Input Selection --- This menu enables to select desired video input:

- Internal input
- External VGA Input
- External SVIDEO Input

Data projector control --- Select this menu to operate the on-screen menu of the projector by means of the control elements placed on the fixture control board.

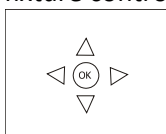

The [RNS] encoder wheel controls movement between arrow fields on the control display and the [ENTER] button enables movement in menu. Pressing the [ENTER] on a circular field (marked "OK") confirms selected options. The [ESC] button leaves menu without saving changes.

15.6 Stand-alone setting

Use this menu to set options for a stand-alone mode as a selection of the program, programming and modifying user programs.

Play Program --- Select this menu to run a built-in program or 10 freely-programmable programs in a loop.

Test Program In Loop --- The option starts built-in test program.

Program 1 In Loop

:

Program 10 In Loop

} These options start user defined programs

Every program can run in two modes:

Normal - This mode uses pan/tilt movement and therefore is good for a dynamic projection.

Static - This mode is suitable for projections on the wall, ceiling or ground without any head movement. By means of items Pan, Tilt and Focus is possible to adjust moving head to the desired position.

Running program is possible to pause by pressing the [ENTER] button.

Edit Program --- Select this menu to edit or create a program. The DigitalSpot 7000 DT has 10 freely-programmable programs, each up to 99 steps. Each program step has a step time, during which effects last in a current step.

Procedure:

1. Select the program you want to edit ("Program 1" - "Program 10") and press the [ENTER] button.
2. Select "Edit Steps" menu and press [ENTER] button.
3. Select the desired program step ("Step 01" - "Step 99") and press [ENTER] button.
4. Select the desired item and press the [ENTER] button. Now you can edit a DMX value of selected item by the [RNS] encoder wheel
5. Press the [ENTER] to save adjusted value.
6. Select another effects (channels) and repeat steps 4 and 5.
7. Select "Save" or "Save and Copy" and press the [Enter] to confirm all adjusted values in a current step:
 - "Save" - saves the current prog. step
 - "Save and Copy" - saves and copies the current prog. step to the next prog. step.

Option "**Snap DMX**"- inserts current values from DMX to all effects (channels). It is very useful function, you don't have to adjust all effects to desired positions, all values are loaded from DMX.

8. Go to the next prog. step, press the [ENTER] and repeat this procedure (steps 4 and 7).

After creation of the program, you can simply reduce its length (by changing the start/end step) using either the "**Start Step**" item or the "**End Step**" item.

Music Trigger --- Select this item to enable the sound control of the running programs via the built-in microphone.

Play DMX Program --- Select this menu to run one of 10 programs which have been recorded via the menu "**Record DMX program**". By pressing the [ENTER] you can switch the running program into the 3 following modes: Pause, Playing, Playing in Loop. The current program step is shown on the fixture display:

PLAYING DMX PROGRAM
Playing program: dprg_02.csv
Step: 27
Time: 00:00:02.632
P a u s e

PLAYING DMX PROGRAM
Playing program: dprg_02.csv
Step: 27
Time: 00:00:02.632
P l a y i n g

PLAYING DMX PROGRAM
Playing program: dprg_02.csv
Step: 27
Time: 00:00:02.632
P l a y i n g I n L o o p

Record DMX Program --- The menu allows to record DMX data that receives the fixture and then replay them again via the menu "**Play DMX program**". There is a list of 10 programs for recording with unlimited steps each. Select desired program number and press the [ENTER] to enter the recording screen.

RECORDING PROGRAM
Recording program: dprg_02.csv
Step: 11
Time: 00:00:01.234
R e c o r d i n g

The data record starts after changing any receiving DMX value. To stop recording, press [ENTER] or [ESC]. Recorded DMX program has the name **dprg_xx.csv** where the xx means the number of the program (e.g. dpr_01.csv, dprg_02.csv....) and is stored in the folder "Programs" accessible by means of FTP. The format of this file is a plain text that allows additional user editing. The first line of the file includes all DMX channels with their starting DMX values and the next lines display changes of DMX values of channel effect and a relevant time of the changes.

Note: If you select the program which contains previously recorded data, the data will be overwritten without warning.

Preset playback --- The menu allows to select a program (or a DMX program), which will be played automatically in a loop after switching the fixture on.

Fixture Off Timer --- The menu offers to control the time during which the fixture is on and, for example, plays the recorded program. The adjusted time period is counted from starting the fixture.

Deactivated Timer --- The item disables the “Fixture Off Timer” option.

Set Timer Hours --- The item enables to set hours for the “Fixture Off Timer”.

Set Timer Minutes --- The item enables to set minutes for the “Fixture Off Timer”.

15.7 Preview mode.

This item enables to display the image, going from the projector, on the fixture’s display.

Note: If this function is called out, the video sequence from projector will not be played continuously because the fixture’s processor has to display this sequence twice at the same time (on the wall and on the display)

15.8 Reset functions

The DigitalSpot 7000 DT can be reset totally or in function modules. Select a desired function to run a reset:

Reset Graphics Engine --- This function resets a graphics engine.

Reset Pan/Tilt System --- This function resets a pan/tilt movement.

Reset Zoom/Focus system --- This function resets a zoom and a focus module.

Reset Iris system --- This function resets iris module.

Reset All systems --- This function enables you to return all fixture’s effects to their standard positions.

15.9 Service menu

Use this menu to read useful information about the fixture.

Power On Time ---Select this submenu to read the number of operation hours of the fixture.

Total Hours - The function shows the total number of the operation hours since the DigitalSpot 7000 has been fabricated.

Resetable Hours - The function shows the number of the operation hours that the DigitalSpot 7000 has been powered on since the counter was last reset. In order to reset this counter to 0, press [ENTER] twice.

Lamp On Time --- Select this submenu to read the number of the operation hours with the projector lamp on.

Total Hours - The function shows the total number of the operation hours with the lamp on since the DigitalSpot 7000 has been fabricated.

Resetable Hours - The function shows the number of the operation hours with the lamp on that the DigitalSpot 7000 has been powered on since the counter was last reset. In order to reset this counter to 0, press [ENTER] twice.

Lamp Strikes --- Select this submenu to read the total number of the projector lamp strikes.

Total Hours - The function shows the total number of the lamp strikes since the DigitalSpot 7000 has been fabricated.

Resetable Hours - The function shows the number of the lamp strikes since the counter was last reset. In order to reset this counter to 0, press [ENTER] twice.

Fixture Temperatures --- Select this submenu to read the temperatures of the projector:

Current - Select this function to read the current temperatures of the fixture interior .

Maximum nonresetable -The function shows the max. temperatures of the fixture interior since the DigitalSpot 7000 DT has been fabricated.

Maximum resetable - The function shows the maximum temperatures of the fixture interior since the respective counter was last reset. In order to reset desired counter to 0, press [ENTER] twice.

Measuring points of temperatures:

Projector temp.1 [°C]].....temperature measured in the data projector

Projector temp.2 [°C].....temperature measured in the data projector

Projector temp.3 [°C]temperature measured in the data projector
Pan /Tilt Board. [°C]temperature on the PCB in the fixture base
Led Panel Board 1 [°C].....temperature in the LED module 1
Led Panel Board 2 [°C].....temperature in the LED module 2

Air Filters --- Regular cleaning of the air filters is very important for the DigitalSpot 7000 DT life and performance. Buildup of dust, dirt and fog fluid residues reduces the fixture's light output and cooling ability. The two items of menu help you to keep cleaning period of the air filters.

Time To Cleanup Filters - The option allows you to read the time which remains to cleaning air filters. Expired time period is signaled by a negative mark at the time value and a warning icon (triangle) on the display with the following message:

"Please , Clean Up Airs Filters."

Clean the filters and reset this menu item (by pressing the "Enter" button twice while this menu is highlighted)

Set Cleanup Timer - Cleaning schedule for the fixture depends on the operating environment. It is therefore impossible to specify accurate cleaning interval. This function allows you to change the cleaning interval of the air filters. This "reminder" value is 50 hours and it is set as default. Inspect fixture within its 50 hours of operation to see whether cleaning is necessary. If cleaning is required, clean all air filters and change the value in this menu on acceptable level. Min. level is 10 hours, max. is 300 hours.

Dataprojector Service --- The menu includes items related to the dataprojector filter.

Filter Used Time – The counter shows the total accumulated time of the filter use.

Remaining Filter Scroll - The counter shows the number of remaining scrolls of the filter. When this counter is counted down to 0, the filter cartridge replacement is necessary – see the chapter “Replacing the filter cartridge in the projector”.

Air Pressure Sensor - The function shows the air pressure measured behind the air filter.

15.10 Special functions

Use this menu for special services like remote servis or software update.

Regenerate Thumbnails --- Use the menu to manage thumbnails behaviour.

Set Thumbnail size - The menu item allows set the size of the thumbnail: 50-min.size, 300-max.size.

Regenerate Thumbnails - By pressing the "Enter" button the refreshing process of gobo/video thumbnails starts. This action should be performed if you have changed gobo/video files and the fixture was not switched off after the change , otherwise the refreshing process runs automatically at starting up of the DigitalSpot 7000 DT.

FTP Server --- The FTP (File Transfer Protocol) server is used to transfer files between the fixture and a PC over an ethernet network by means of FTP client running on your PC. The "FTP Server" menu allows control of an access to the fixture's folders.

Set Account - The option allows you to protect the access to the fixture folders by setting the name and password. The same data must be entered in FTP terminal running on your PC.

Allow Anonymous - If this option is set "Yes" ,no password is required in FTP terminal but the user name may be "ftp" or "anonymous".

HTTP Access --- This menu enables to set access privileges which are used at entering to the Remote control program via your WWW browser.

Set Account - The option allows you to protect the access to the Remote control program by setting the name and password. The same data must be used in the Remote control program running on your PC or a light control console.

Allow Anonymous - If this option is set "Yes" ,no password is required at entering to the Remote control program.

USB Data Synchronization --- The menu allows transfer of media files (images, videos) and software files between the USB stick and fixture's hard disk and related operations.

The USB stick must contain the following folders structure:

Top level folder

```

Media
    000
    001
    002
    :
    240
Programs
Update
Log
    
```

To create the folders structure mentioned above, use the option "**Init Flash Disc**". After creating folders structure on the USB stick you may load/download files into folders/subfolders. Maximum number of media files in one Media subfolder is 240. **Subfolders 000-020 are reserved for default images/videos and cannot be changed (you cannot copy media files into these subfolders).**

To upload a file/folder from the USB stick to the Media folder in the fixture:

1. Insert the USB stick to the USB port, select "**USB Data Synchronize**" from the menu and press the [ENTER], "**USB1**" or "**USB2**" (depends on used USB port) is displayed on the screen.
2. Press the [ENTER], select "**Open**", press the [ENTER].
3. Select "**Media**", press the [ENTER],
4. If you want to copy all Media folder (including subfolders 000-240), select item "**Synchronize to Fixture**". If you want to copy only one subfolder (e.g. 035), select "**Open**", press the [ENTER], select desired subfolder from a list of subfolders, press the [ENTER] and select option "**Synchronize to Fixture**". If you want to copy only one file, select "**Open**" and press the [ENTER]. Select the desired file, press the [ENTER] and confirm a question in a dialogue box.

To download folder from the Media folder to the USB stick.

1. Insert the USB stick to the USB port, select "**USB Data Synchronize**" from the menu and press the [ENTER]. "**USB1**" or "**USB2**" (depends on used USB port) is displayed on the screen.
2. Press the [ENTER], select **Open**, press the [ENTER].
3. Select "**Media**", press the [ENTER],
4. If you want to copy all Media folder from the fixture (including subfolders 000-240), select item "**Synchronize from Fixture**". If you want to copy only one subfolder (e.g. 035), select "**Open**", press the [ENTER], select desired subfolder from a list of subfolders, press the [ENTER] and select option "**Synchronize from Fixture**". If you want to copy only one file, select "**Open**" and press Enter. Select the desired file, press the [ENTER] and confirm a question in a dialogue box.

Software Update --- This menu allows to update graphical software or hardware processors software.

You have to download the latest version of the DigitalSpot 7000 DT software from ROBE website to your hard disk and then use either Ethernet network or the USB stick to move this file to the relevant folder in the DigitalSpot 7000 DT.

Copying software update file from the USB stick to the fixture:

1. Insert the USB stick to the USB port, select "**USB Data Synchronize**" from the menu and press Enter. There is an **USB1** or **USB2** (depends on used USB port) displayed on the screen.
2. Press Enter, select **Open**, press the [ENTER].
3. Select **Update** and press the [ENTER]. If you want to upload whole Update folder to the fixture, select option "**Synchronize to Fixture**".

If you only want to copy one or more files to the fixture, select option "**Open**" and press the [ENTER]. Select desired file, press the [ENTER] and confirm a question in a dialogue box.

After copying update file to the fixture, the desired software update will be activated by confirming the follow items:

Update Graphical Software - starts update of the graphical software.

If the message **Please Update HW Processors in Menu "Special Functions"** will appear after updating, run update of the hardware functions.

Update HW processors Software - starts update of hardware functions like pan, tilt, focus...etc.

Update Media Content - starts update of the factory media folders 00-20 (pictures, videos)

Calibrate Values --- This menu serves for a fine calibration of effects.

Iris Calibration - allows fine calibration of a mechanical iris.

Generate Log File --- This item starts generating a log file. The file is saved in a folder "Log" on the hard disk. This file records events in a certain scope in order to provide an audit trail that can be used to diagnose problems of the fixture.

Remote servis --- This menu provides necessary items for remote servis of the DigitalSpot 7000 DT.

15.11 Fixture Off

This function shuts down the fixture. The projector lamp is switched off as first and after cca 20 seconds is switched off the fixture.

16. Keystones

16.1 Global keystone parameters

If an image is output from the DigitalSpot 7000 DT at an angle the image may be skewed. Eight keystone channels (*KeyStone Top Left X*, *KeyStone Top Left Y*, *KeyStone Top Right X*, *KeyStone Top Right Y*, *KeyStone Bottom Right X*, *KeyStone Bottom Right Y*, *KeyStone Bottom Left X*, *KeyStone Bottom Left Y*) adjust the image shape. It is possible to control each of the four corners of the image and reshape it.

Default DMX value is 0, it means that no keystone correction has been used.

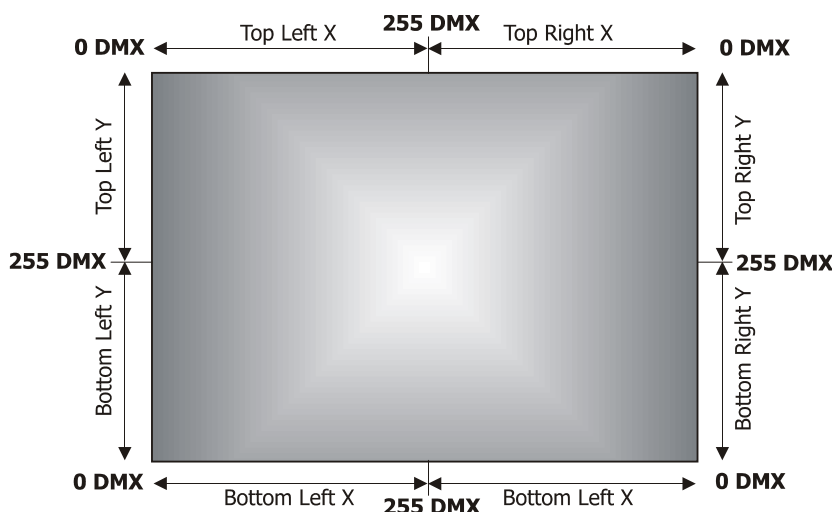

Setting all keystone values to 0 will place all four corners of the image at the four corners of the projector output. The keystone values can also be used to create interesting skewing effects.

For the picture merging are important both the **KeyStone X-ratio** and **KeyStone Y-ratio** channels for correction of the image distortion caused by placing projectors at different distances from the final image.

use channel the *KeyStone X-ratio* for correction

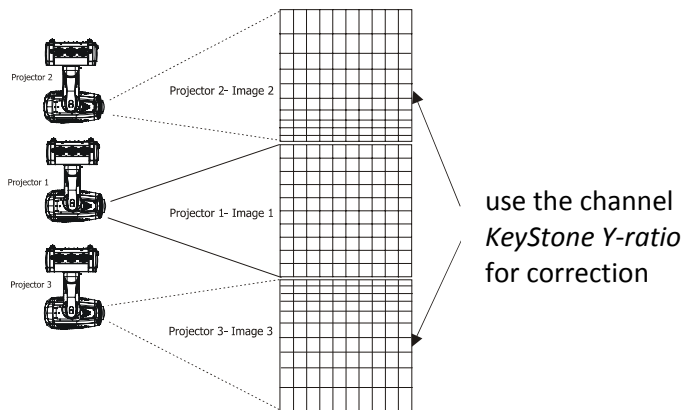
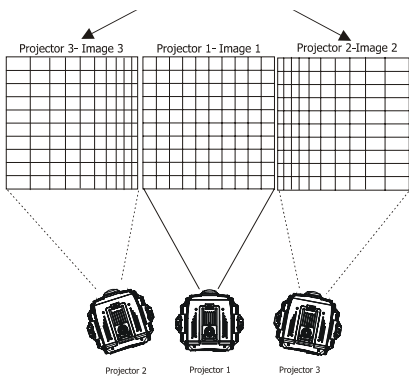

16.2 Layer keystone parameters

By the global keystone parameters stated above you can control each of the four corners of the graphics output individually to reshape your image to a form that is projected correctly.

By the layer keystone parameters you can control all four corners of the image at the same time. With these parameters you can create the same skewing and shape effects like with the global keystone parameters but on each gobo layer.

Major use of these effects is in a situation where the gobo mask is applied on a layer and you need to adjust a mask shape onto some object on the scene. More important is adjusting of the inner part of the image on the layer than the outer shape of the graphics output.

Characteristic case is a composition of 2 layers: the layer 1, where is applied a picture of the landscape and the layer 2, where is a gobo mask selected (see picture below).



To adjust desired image shape you can use the following (keystone) parameters on the gobo layer 2:

1. Layer zoom in X and Y direction.

The channels *Gobo zoom X coarse* and *Gobo zoom X fine* allow 8-bit/16-bit zooming in X-direction.

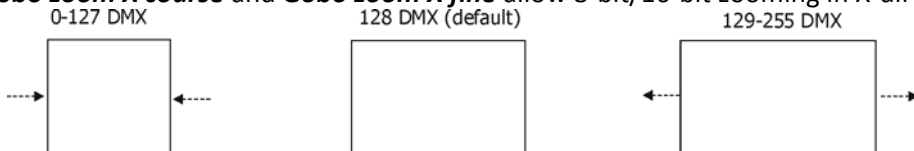

The channels *Gobo zoom Y coarse* and *Gobo zoom Y fine* allow 8-bit/16-bit zooming in Y-direction.

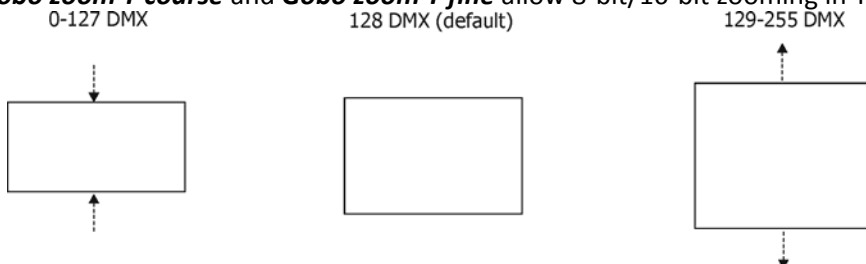



2. Gobo position in X and Y direction.

The channels **Gobo position X coarse** and **Gobo position X fine** allow 8-bit/16-bit positioning in X-direction.

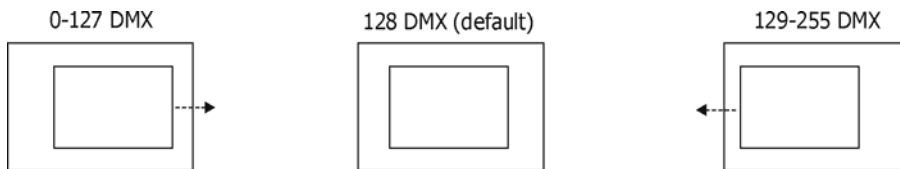

The channels **Gobo position Y coarse** and **Gobo position Y fine** allow 8-bit/16-bit positioning in Y-direction.

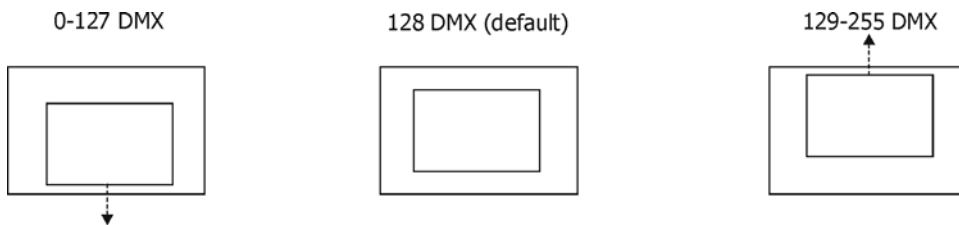

3. Layer skewing along X and Y axis.

On the channel **Gobo effect 1 selection** adjust a DMX value=150 and using the control parameters 1 and 2 you can skew the image in either X or Y axis.

The channel **Gobo effect 1 – Parameter 1** skews the image in X-axis.

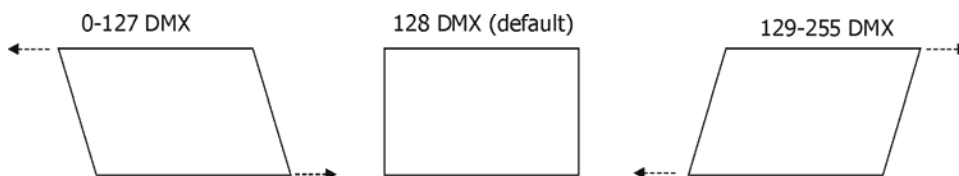

The channel **Gobo effect 1 – Parameter 2** skews the image in Y-axis.



4. Layer Squeezing/Stretching along X and Y axis.

On the channel **Gobo effect 1 selection** adjust a DMX value=150 and using the Control Parameters 3 you can squeeze the image in X axis.

The channel **Gobo effect 1 – Parameter 3** squeezes/stretches the image edges in Y-axis.

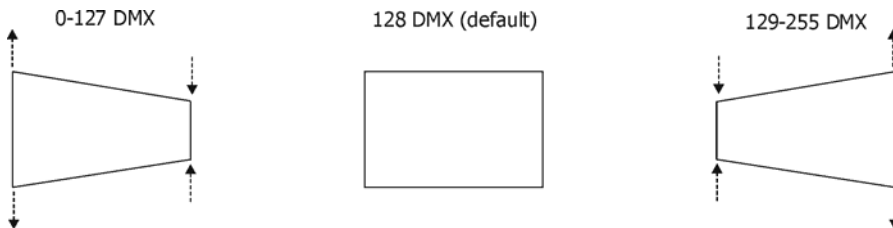

On the channel **Gobo effect 2 selection** adjust a DMX value=150 and using the control parameters 1 you can squeeze the image in Y axis. Note. To allows this effect, the channel **Gobo effect 1 selection** has to be set to DMX=150.

The channel **Gobo effect 2 – Parameter 1** squeezes/stretches the image edges in X-axis.

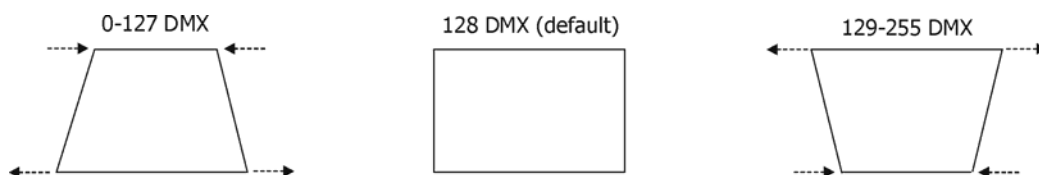



5. Image X-ratio and Y-ratio.

On the channel **Gobo effect 2 selection** adjust a DMX value=150 and the second and third parameter control image X-ratio and Y-ratio.

Note. To allows this effect, the channel **Gobo effect 1 selection** has to be set at DMX=150.

The channel **Gobo effect 2 – Parameter 2** compresses or expands the image in X- axis

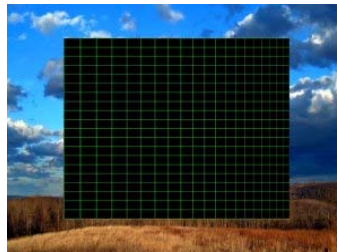
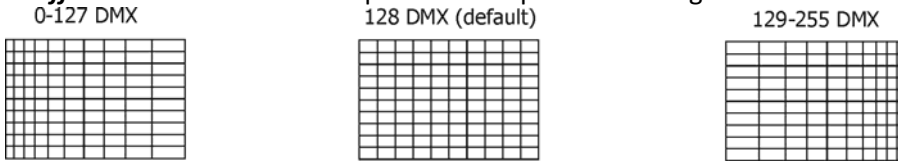

The channel **Gobo effect 2 – Parameter 3** compresses or expands the image in Y- axis.

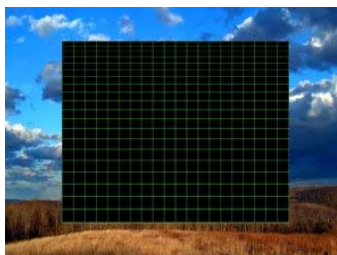
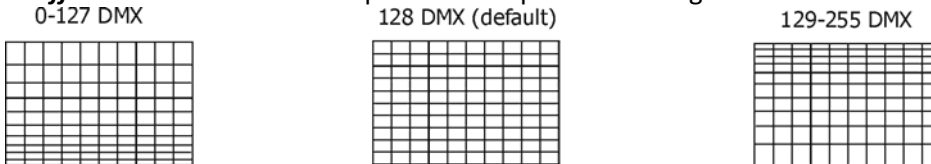

After shaping the image by means of the parameters stated above, you can apply the global banner effects on the whole graphics output and this final image should appear for instance like this:



17. In Frame and Out Frame parameters

You can select any segment of a video file for playback by assigning parameters for In Frame (start point) and an Out Frame (end point) as pictured below.

The In Frame parameter corresponds to a 16-bit DMX value equal to a starting point for the playback segment of the selected video file. The Out Frame parameter corresponds to a 16-bit DMX value equal to an end point for the playback segment of the selected video file.

1. Assigning the In Frame DMX values to 0 and Out Frame DMX values to 255 you will playback the entire video file.

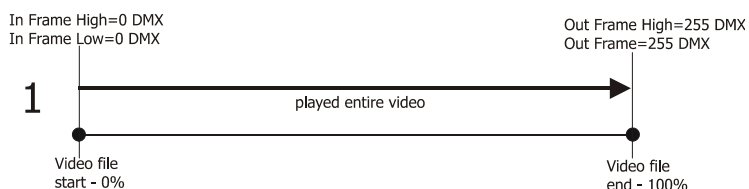

2. You can create a segment anywhere between the beginning and the end of the video file.

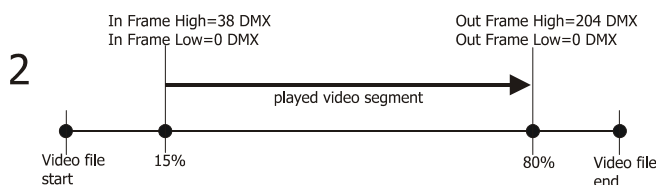

3. It is possible to skip a segment in the video file by setting the In Frame to a point following the Out Frame value.

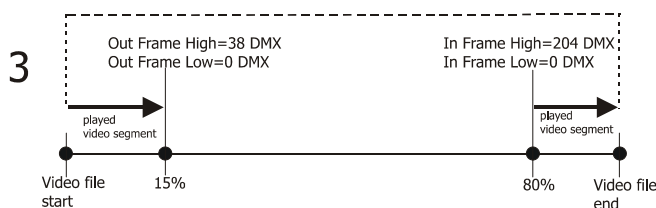

18. Video Control

The channel **Gobo control** defines how the current layer will be 'composed' with the previous layers and the playback options in each mode. The Digital Spot 7000 supports the following options:

Copy mode (0-17 DMX): In this mode, the pixels of the layer are written on top of the previous layers.

Addition mode (20-37 DMX): In this mode, the pixel values of the current layer are added to the ones of the previous layers. This means that "dark" pixels in the current layer image won't alter the pixels that are underneath while "light" pixel will saturate the image underneath.

Subtraction mode (40-47DMX): In this mode, the pixel values of the current layer are subtracted from the pixel value in the underlying layers. Dark pixel from the current layer won't alter the pixel of the layers underneath while light pixel will darken them.

Multiplication mode (60-77 DMX): In this mode, the pixels from the current layer will be multiplied by the pixels of the underlying layers. For a pixel to appear bright in the output, the equivalent pixel of the current layer and the underlying layer needs to be bright. If any of the layers has a dark pixel, the result will be dark.

Minimum mode (80-97 DMX): This mode takes the pixel that is the darkest between the current layer and the layer underneath

Maximum mode (100-117 DMX): This mode takes the pixel that is the brightest between the current layer and the layer underneath.

The playback options:

<u>DMX value</u>	<u>Playback option</u>	<u>Meaning</u>
0.	Play forward continuously if dimmer >0	Plays the video segment from In Frame point to Out Frame point, continuous looping. The dimmer value has to be greater than 0.
1	Play forward once if dimmer >0	Plays the video segment from In Frame point to Out Frame point and holds on the last frame. The dimmer value has to be greater than 0.
2	Pause	Stops playback of video file at the current playing
3	Play forward in continuous loop	Plays the video segment from In frame point to Out Frame point, looping continuously frame
4	Play forward once	Plays the video segment from In Frame point to Out Frame point and holds on the last frame
6	Scrub (display) the selected In Frame	Displays the frame which has been defined by the In Frame value.
7	Scrub (display) the selected Out Frame	Displays the frame which has been defined by the Out Frame value.

19. Playback speed

The **Playback speed** channel controls the speed of video playback at selected playback options.









<u>DMX value</u>	<u>Playback speed</u>	<u>Meaning</u>
0 or 128	Normal speed	Plays back video files at the original record. speed
1-127	Slow speeds from slowest to normal	Plays back video files at an increasing speed, from the slowest to the original recorded speed
129-255	Faster than normal to fastest	Plays back video files at an increasing speed, from faster than normal to the fastest.

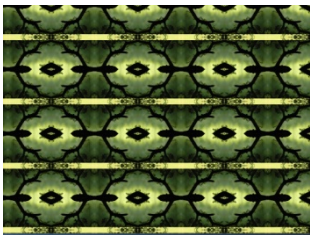

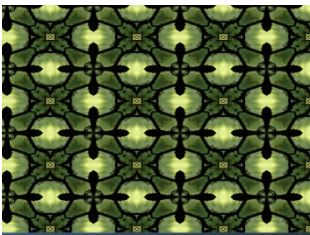
20. Graphic effects

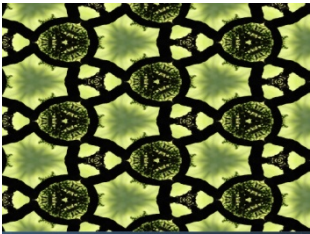
There are two gobo effect channels on each gobo layer (**Gobo effect 1 selection**, **Gobo effect 2 selection**), which offer amount of effects that can be applied to the current running picture/video. Each effect channels have three control channels - **Parameter 1**, **Parameter 2**, **Parameter 3** – which allow to change the behaviour of selected effect (e.g. speed, amount...)

20.1 Kaleidoscopic effect

The kaleidoscopic effect section on the channel **Gobo effect 1 selection** allows selection of the static or dynamic mode of the kaleidoscopic effect according to the desired mosaic segment.

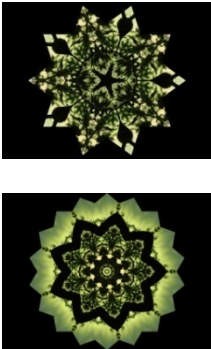
DMX value		Segment of mosaic	Example	Source picture
Static mode	Dynamic mode			
100	101	Square 		
102	103	Right triangular 		
104	105	Isosceles triangular 		
106	107	Triangular 1 		
108	109	Triangular 2 		

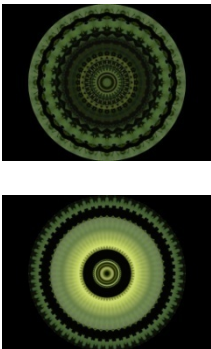
DMX value		Mosaic effect	Examples	Source picture
Static mode	Dynamic mode			
110	111	<p>Centered Kaleidoscope (rough)</p> <p><i>Note: As the effect does not cover all projection are, the image from the lower layer can be displayed at the sides of the effect.</i></p> <p><i>E.g. Centered Kaleidoscope effect has been selected on the layer 4 and the picture on the layer 3 is visible at the sides of the effect.</i></p>		
112	113	<p>Centered Kaleidoscope (fine)</p> <p><i>Note: As the effect does not cover all projection are, the image from the lower layer can be displayed at the sides of the effect.</i></p> <p><i>E.g. Centered Kaleidoscope effect has been selected on the layer 4 and the picture on the layer 3 is visible at the sides of the effect.</i></p>		

Meaning of the control channels depends on the kaleidoscope mode which has been selected:

Static mode.

Gobo effect 1- Parameter 1: Density of mosaic segments

DMX value	Function
0 - 255	Density of mosaic segments from large (0 DMX) to small (255 DMX)

If the effect "Centered Kaleidoscope (rough)" is selected, meaning of the **Parameter 1** is the following:

DMX value	Function
0 - 255	Shape (diamond (0 DMX) → circle (255 DMX)) and a number of mirroring planes

Gobo effect 1- Parameter 2: Content of segments-coarse

DMX value	Function
0 - 255	Coarse adjustment of the segments content

Gobo effect 1- Parameter 3 : Content of segments-fine

DMX value	Function
0 - 255	Fine adjustment of the segments content

Dynamic mode.

Gobo effect 1- Parameter 1: Density of mosaic segments

DMX value	Function
0 - 255	Adjusting density of mosaic segments from large (0 DMX) to small (255 DMX)

If the effect “Centered Kaleidoscope (fine)” is selected, meaning of the **Parameter 1** is the following:

DMX value	Function
0 - 255	Shape and a number of mirroring planes

Gobo effect 1- Parameter 2: Size and pulsation of the segments content

DMX value	Function
0 - 128	Size of segments content from small (0 DMX) to large (128 DMX)
129 - 255	Speed of segment pulsation from slow (129 DMX) to fast (255 DMX)

Gobo effect 1- Parameter 3: Movement of the segments content

DMX value	Function
0 - 127	Backward movement of segments content from fast (0 DMX) to slow (127 DMX)
128	No movement
129-255	Forward movement of segments content from slow (129 DMX) to fast (255 DMX)

20.2 Circular effect (Fish eye)

The effect allows to convert a picture from an oblong format to a circle format and adjust the character of the circular effect.

The circular effect can be activated on each gobo layer if you set the **Gobo Effect 1 Selection** channel to a DMX Value of 90. The **Parameter 1** of this effect changes the character of the circular effect from concave to convex. The **Parameter 2** and **Parameter 3** serve for adjusting X ratio and Y ratio of the source image. A default value for all three parameters is 128.

Control parameters:

Control parameter	Controlled item	DMX value	Function
Parameter 1	Character of the circular effect	0-255	concave (0) → no adjustment (128) → convex (255)
Parameter 2	X-ratio of the image	0-255	continual adjustment
Parameter 3	Y-ratio of the image	0-255	continual adjustment



20.3 RGB (CMY) effects

The RGB effects section on the channel **Gobo effect 2 selection** allows to apply a variety of RGB colour swapping effects to graphic objects.

RGB subtract All Pixels (DMX value=50) – the effect reduces colour values across all pixels.

Associated control parameters:

Control parameter	Controlled item	DMX value	Function
Parameter 1	Red colour element	0-255	no adjustment → minimum saturation
Parameter 2	Green colour element	0-255	no adjustment → minimum saturation
Parameter 3	Blue colour element	0-255	no adjustment → minimum saturation

RGB add All Pixels (DMX value=51) – the effect increases colour values across all pixels.

Associated control parameters:

Control parameter	Controlled item	DMX value	Function
Parameter 1	Red colour element	0-255	no adjustment → maximum saturation
Parameter 2	Green colour element	0-255	no adjustment → maximum saturation
Parameter 3	Blue colour element	0-255	no adjustment → maximum saturation

RGB add non-black Pixels (DMX value=52) – the effect increases colour values across all pixels except black pixels.

Associated control parameters:

Control parameter	Controlled item	DMX value	Function
Parameter 1	Red colour element	0-255	no adjustment → maximum saturation
Parameter 2	Green colour element	0-255	no adjustment → maximum saturation
Parameter 3	Blue colour element	0-255	no adjustment → maximum saturation



RGB subtract/add All Pixels (DMX value=53) – the effect reduces/ increases colour values across all pixels.

Associated control parameters:

Control parameter	Controlled item	DMX value	Function
Parameter 1	Red colour element	0-255	Min. saturat. (0) → no adjustment (128) → max. saturation(255)
Parameter 2	Green colour element	0-255	Min. saturat. (0) → no adjustment (128) → max. saturation(255)
Parameter 3	Blue colour element	0-255	Min. saturat. (0) → no adjustment (128) → max. saturation(255)

Swap RGB to RBG (DMX value=54) – the effect swaps green and blue colour in all pixels. Red colour remains without change.

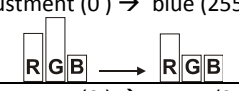
Associated control parameters:

Control parameter	Controlled item	DMX value	Function
Parameter 1	Red colour element	0-255	No change.
Parameter 2	Green colour element	0-255	no adjustment (0) → blue (255) 
Parameter 3	Blue colour element	0-255	no adjustment (0) → green (255) 

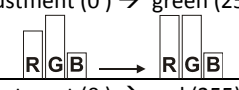
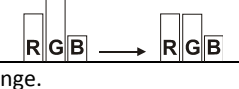

Swap RGB to GRB (DMX value=55) – the effect swaps red and green colour in all pixels. Blue colour remains without change.

Associated control parameters:

Control parameter	Controlled item	DMX value	Function
Parameter 1	Red colour element	0-255	no adjustment (0) → green (255) 
Parameter 2	Green colour element	0-255	no adjustment (0) → red (255) 
Parameter 3	Blue colour element	0-255	No change.

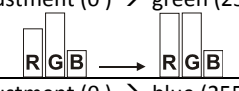
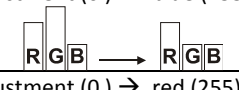

Swap RGB to GBR (DMX value=56) – the effect swaps red to green, green to blue and blue to red colour in all pixels.

Associated control parameters:

Control parameter	Controlled item	DMX value	Function
Parameter 1	Red colour element	0-255	no adjustment (0) → green (255) 
Parameter 2	Green colour element	0-255	no adjustment (0) → blue (255) 
Parameter 3	Blue colour element	0-255	no adjustment (0) → red (255) 

Swap RGB to BRG (DMX value=57) – the effect swaps red to blue, green to red and blue to green colour in all pixels.

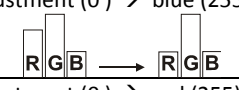
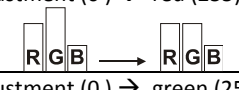
Associated control parameters:

Control parameter	Controlled item	DMX value	Function
Parameter 1	Red colour element	0-255	no adjustment (0) → blue (255) 
Parameter 2	Green colour element	0-255	no adjustment (0) → red (255) 
Parameter 3	Blue colour element	0-255	no adjustment (0) → green (255) 

Swap RGB to BGR (DMX value=58) – the effect swaps red and blue colour in all pixels. Green colour remains without change.

Associated control parameters:

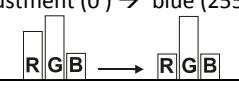
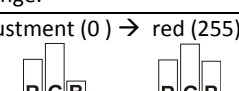
Control parameter	Controlled item	DMX value	Function
Parameter 1	Red colour element	0-255	no adjustment (0) → blue (255) 
Parameter 2	Green colour element	0-255	No change.
Parameter 3	Blue colour element	0-255	no adjustment (0) → red (255) 

RGB invert (DMX value=59) – the effect inverts red, green and blue colour in all pixels.

Associated control parameters:

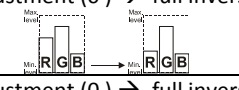
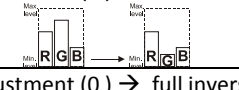
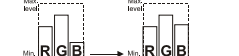
Control parameter	Controlled item	DMX value	Function
Parameter 1	Red colour element	0-255	no adjustment (0) → full inversion (255) 
Parameter 2	Green colour element	0-255	no adjustment (0) → full inversion (255) 
Parameter 3	Blue colour element	0-255	no adjustment (0) → full inversion (255) 

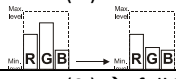
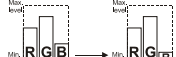

Invert and swap RGB to BRG (DMX value=60) – the effect swaps red, green and blue colour to inverted BRG in all pixels.

Associated control parameters:

Control parameter	Controlled item	DMX value	Function
Parameter 1	Red colour element	0-255	no adjustment (0) → full inverted blue (255) 
Parameter 2	Green colour element	0-255	no adjustment (0) → full inverted red (255) 
Parameter 3	Blue colour element	0-255	no adjustment (0) → full inverted green (255) 

Invert and swap RGB to GBR (DMX value=61) – the effect swaps red, green and blue colour to inverted GBR in all pixels.

Associated control parameters:

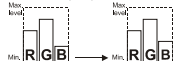
Control parameter	Controlled item	DMX value	Function
Parameter 1	Red colour element	0-255	no adjustment (0) → full inverted green (255) 
Parameter 2	Green colour element	0-255	no adjustment (0) → full inverted blue (255) 
Parameter 3	Blue colour element	0-255	no adjustment (0) → full inverted red (255) 

Colour to Alpha (DMX value=62) – the effect changes the transparency level of an image's element colour values. You can adjust the transparency of individual colours from completely transparent to full opacity using the control parameters 1, 2 and 3:

Control parameter	Controlled item	DMX value	Function
Parameter 1	Red colour element	0-255	Changes the red colour element transparency
Parameter 2	Green colour element	0-255	Changes the green colour element transparency
Parameter 3	Blue colour element	0-255	Changes the blue colour element transparency

Colour to Alpha Inverted (DMX value=63) – the effect changes the transparency level of the inverse of an image's element colour values.

Associated control parameters:

Control parameter	Controlled item	DMX value	Function
Parameter 1	Red colour element	0-255	Changes the inverted red colour element transparency
Parameter 2	Green colour element	0-255	Changes the inverted green colour element transparency
Parameter 3	Blue colour element	0-255	Changes the inverted blue colour element transparency

DigitalSpot 7000 DT

RGB scale (DMX value=68) – the effect changes the output intensity of red, green and blue colour in all pixels.

Associated control parameters:

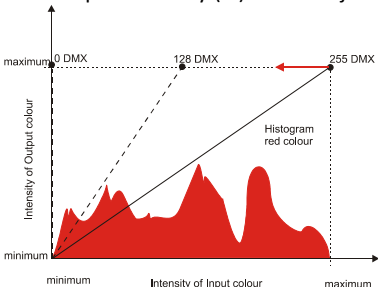
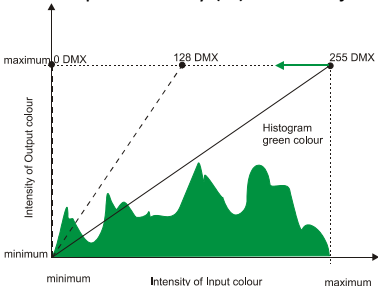
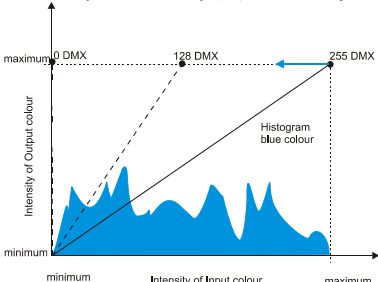
Control parameter	Controlled item	DMX value	Function
Parameter 1	Red colour	0-255	Changes the inclination of conversion line for red colour from max. output intensity (0) → no adjustment (255) 
Parameter 2	Green colour	0-255	Changes the inclination of conversion line for green colour from max. output intensity (0) → no adjustment (255) 
Parameter 3	Blue colour	0-255	Changes the inclination of conversion line for blue colour from max. output intensity (0) → no adjustment (255) 

Brightness scale (DMX value=69) – the effect changes the output intensity of brightness of the picture.

Associated control parameters:

Control parameter	Controlled item	DMX value	Function
Parameter 1	Inclination of the conversion line – bottom point	0-255	Changes the inclination of conversion line for output brightness from no adjustment (0) → min. brightness (255)
Parameter 2	Inclination of the conversion line – top point	0-255	Changes the inclination of conversion line for output brightness from max. brightness (0) → no adjustment (255)

Example:

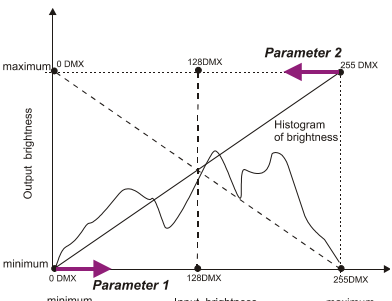

21. Media content management

As you seen earlier in chapter "12. Folder organization", the DigitalSpot 7000 DT uses the root folder named "Media". This folder contains subfolders (000,001...240) and inside each subfolder is the collection of media that the subfolder holds. The files in subfolders are sorted in an alphabetic or numerical order and assigned to DMX. The first part of the file name should be a 3-digit number followed by an underscore and a name e.g.:

001_sun.png..... 1 DMX

002_snow_castle.png.....2 DMX

:

255_apple.png.....255 DMX

Subfolders 000-020 are reserved for default (factory) gobos/videos and their contents cannot be changed.

User subfolders 21-240 and their contents can be mowed between fixtures and your local drive (PC) as well as between fixtures. Which method you use depends on:

- how much content you want to move
- whether the fixture is currently connected to the Ethernet fixture link

There is several methods for moving user content files and folders between fixtures and a local drive and between fixtures each other. You can use:

- FTP client in Windows explorer window (fixtures have to be connected to Ethernet link)
- FTP client in Mozilla Firefox (fixtures have to be connected to Ethernet link)
- USB stick
- option "Contents Synchronization" in a Remote control program (fixtures have to be connected to Ethernet link).

For detail description see articles below.

21.1 Moving files between the fixture and PC

1. FTP client in explorer window.

All fixtures have to be linked to the Ethernet link. The proper network configuration and IP address setting of your PC is very important. The following is an example of an IP setting for Windows XP :

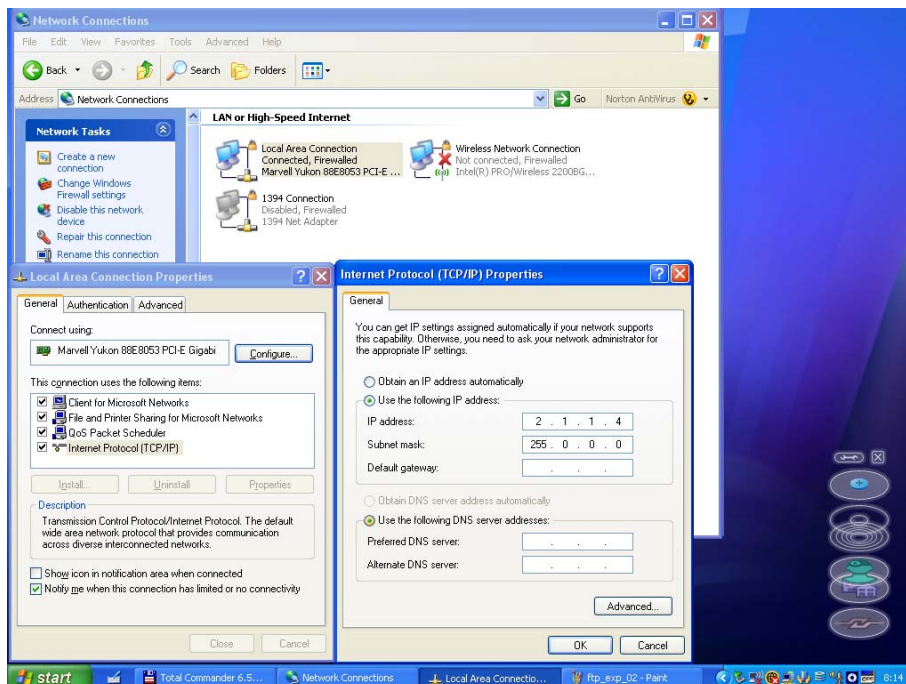

DigitalSpot 7000 DT

After network configuration, type the IP address of the DigitalSpot 7000 DT in address line in your Windows explorer window. Use this format **ftp:// 2.X.X.X /** (e.g. ftp://2.236.2.88/- see picture below).

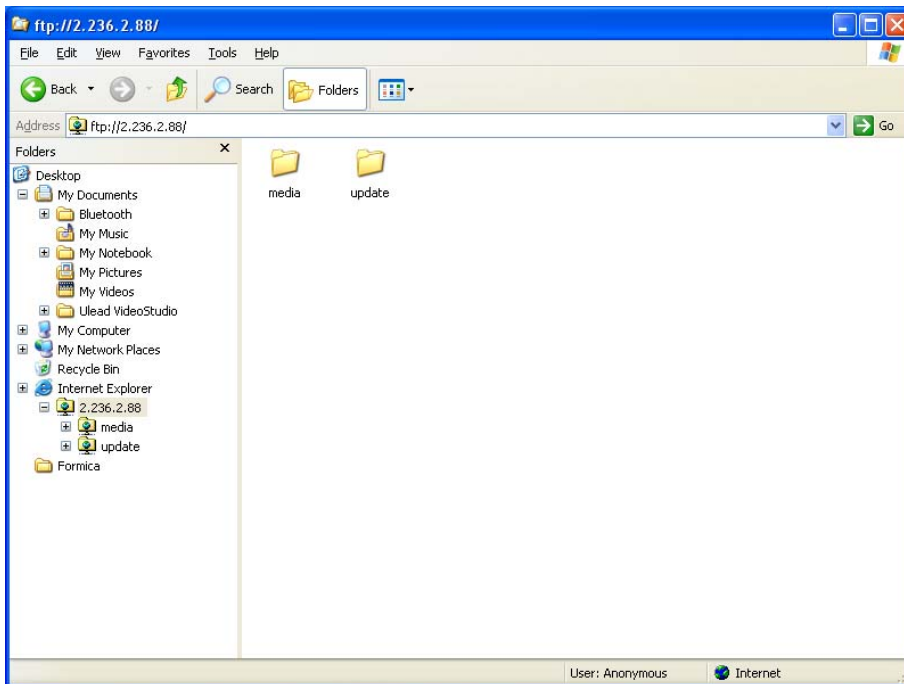

If all settings are proper, you will see "Media" and "Update" folders in the Windows explorer window and now you can work with them as local folders and files.

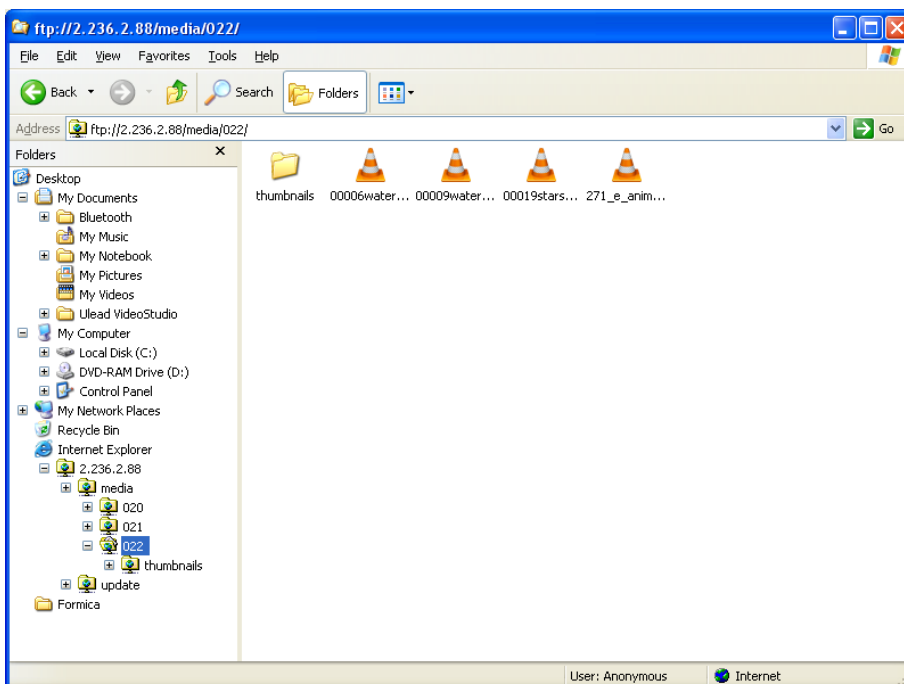

See also "Special functions"--> "FTP Server".

2. FTP client in Mozilla Firefox

If you use Mozilla Firefox as your web browser, you can install FTP client into the browser. To install FTP client for Mozilla Firefox on your computer.

1. Run Mozilla Firefox.
2. Select option “Tools” from the Menu bar, select “Add-ons” item.

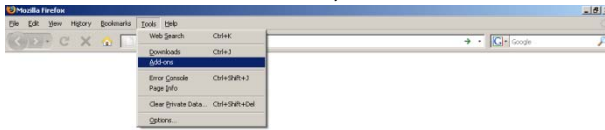

3. Select option “Get Add-ons” from the standard toolbar, type **fireftp** into the top left field and press Enter key.
4. Click on the Add to Firefox.. button and follow the installation instructions.

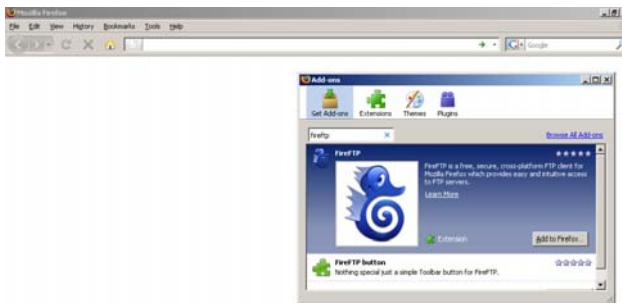

5. Follow the installation instructions until the installation has finished.

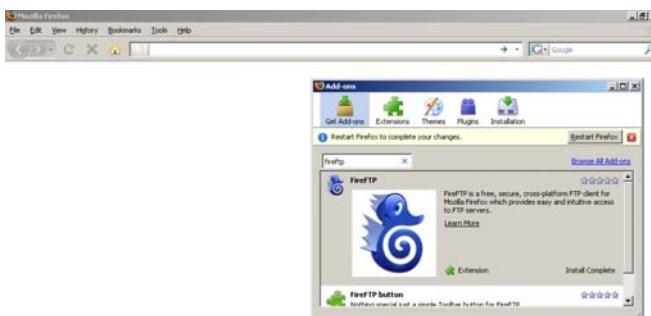

5. After installation, go to the “Tools”, select “Add-ons” item, select “Extensions” in the toolbar and click on the Options button. Select “Interface” menu and check option “**Configure FTP links in Firefox to automatically use FireFTP**”.

DigitalSpot 7000 DT

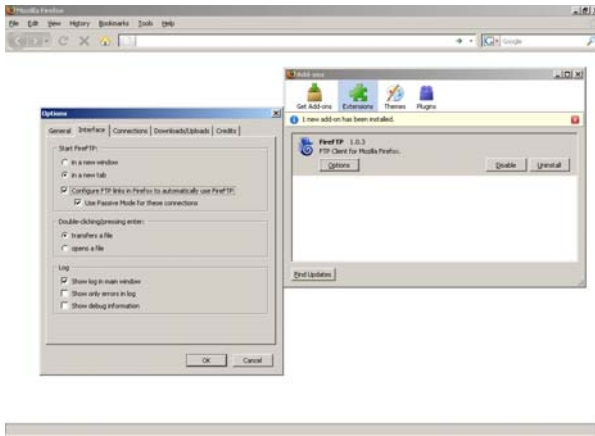

After installing FTP client, run Mozilla Firefox and type the IP address of desired fixture in ftp format e. g. **ftp://2.97.181.89** and a Fire FTP window will appear.

If you do not want to keep in mind IP addresses of all connected fixtures, you can use the Remote configuration program (by typing the IP address of one fixture to the web browser in http format e. g. **http://2.97.181.89**) and go to the Contents Synchronization window where a list of available fixtures is offered.

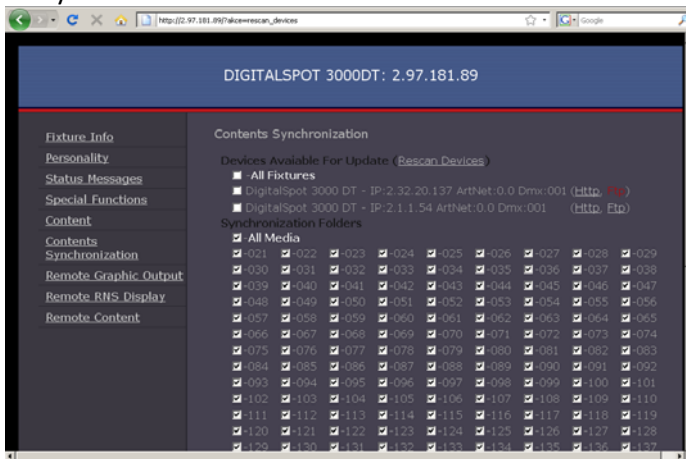

You need to know only IP address of one fixture as the rest of connected fixtures with their IP addresses is displayed in this window. By clicking on the Ftp option (in parenthesis) at desired fixture the FireFTP window will appear:

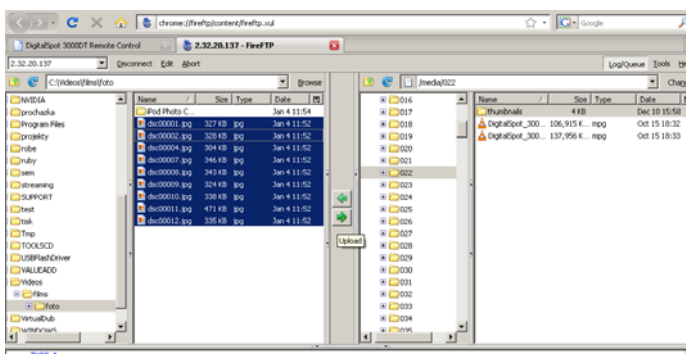

Now you can move files between PC and desired fixture.

3. Via USB stick.

Next way, how to add or remove files from the media folders is by means of the USB stick - see "USB Data Synchronization" in chapter "Special functions".

21.2 Moving files between networked fixtures

The option "Contents Synchronization" in a "Remote control program" running on your PC offers easy control of file transfer between networked fixtures via web browser. (For detail description of the Remote configuration program see chapter "Remote control of the fixture via web browser" below).

A window of the **Contents Synchronization**:

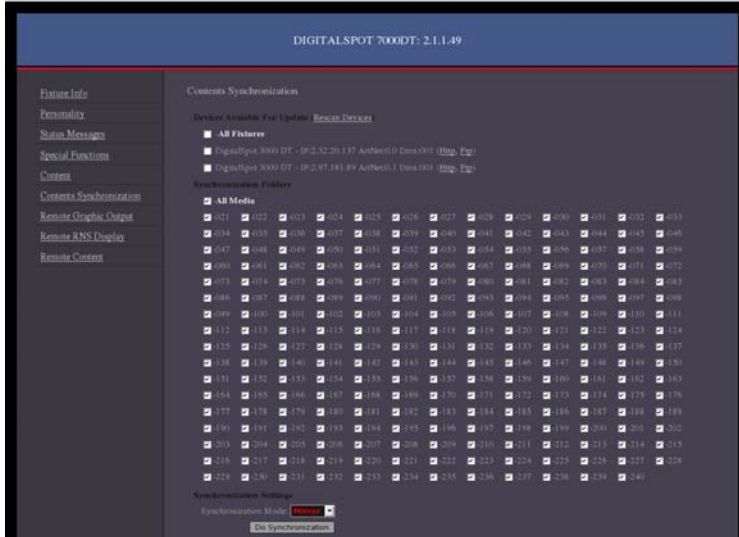

There is a list of available fixtures under **Device Available for Update**. If you connect another fixture to a network, use option "**Rescan Devices**" to refresh the list of fixtures.

A list of available folders with their check boxes is placed under **Synchronization Folders**.

Option "**Synchronization Mode**" gives you possibility to select how the files will be moved to target folder:

"**Mirror**"- a content of the target folder will be fully overwritten by a content of the source folder.

"**Add**"- files from the source folder are added to existing files in the target folder.

The last folder "**Update**" next to the gobo folder no. 240 serves for a synchronization of the "update" folders between the fixtures.

To move files.

1. Select desired folders check boxes. If you want to select all folders, check All Media check box.
2. Select a target fixture (fixtures) in a list of available fixtures.
3. Select desired Synchronization Mode and click the "Do Synchronization" button to start the file transfer.

22. Remote control of the fixture via WWW browser

The DigitalSpot 7000 DT offers a remote control of the fixture and displaying useful information about the fixture including the gobo folders contents via www browser.

The fixtures has to be connected via an ethernet (with Art-Net communication protocol) to a network. The PC or light console has to be connected to the same network as the fixtures. Use only the IP addresses which have first number 2 like 2.X.X.X, e.g. 2.236.2.88.

To run a Remote control program type the IP address of the desired fixture to your www browser (e.g. **http://2.236.2.88**) and the input window of the Remote Control will appear.

Note: if you wish to have access to this utility under password, use the menu "HTTP Access" in "Special functions" to set a password.

The Remote Control screen offers these options:

Fixture Info - the window with information about current fixture address, disk space, software versions etc.

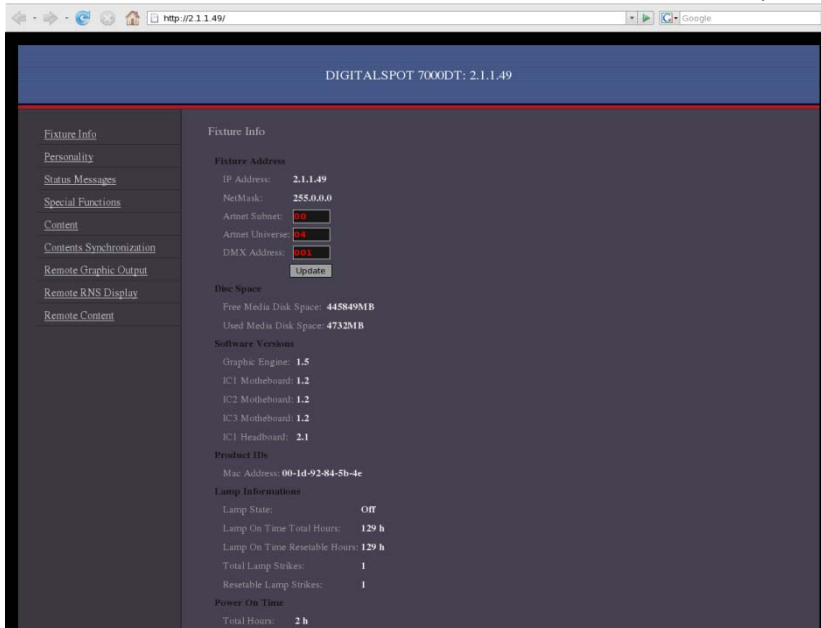

Personality - the window allows you to change the fixture settings like a pan/tilt reverse, feedback, speed, lamp status, DMX protocol selection etc.



DigitalSpot 7000 DT

Status Messages -the window under this option displays error and status messages.

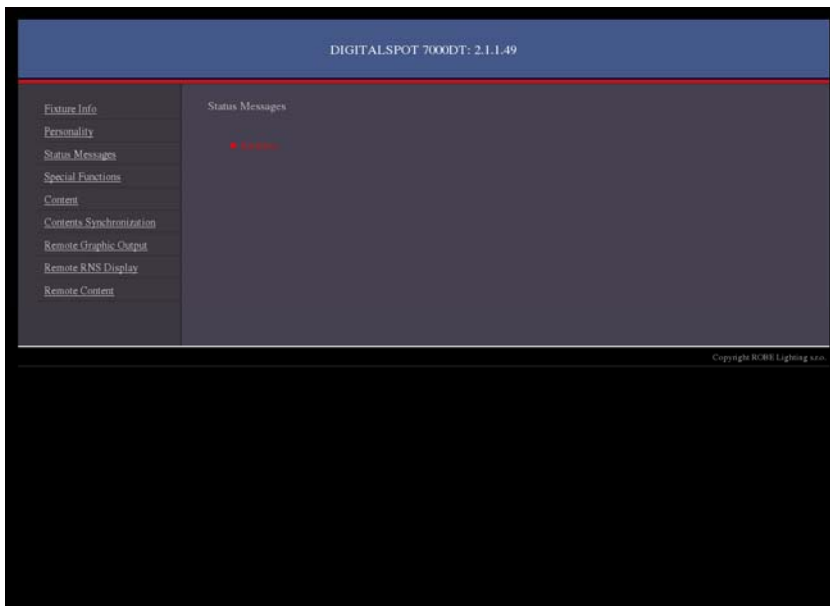

Special Functions - the window offers several items:

"**Thumbnails size**" - changing the size of the thumbnails. The change takes effect in the item "Content". If you change the thumbnail size, use the button "**Update**" below the size box.

"**Log File**" - enables to generate log file for service purposes.

"**System Reboot**"- starts reboot of the fixture

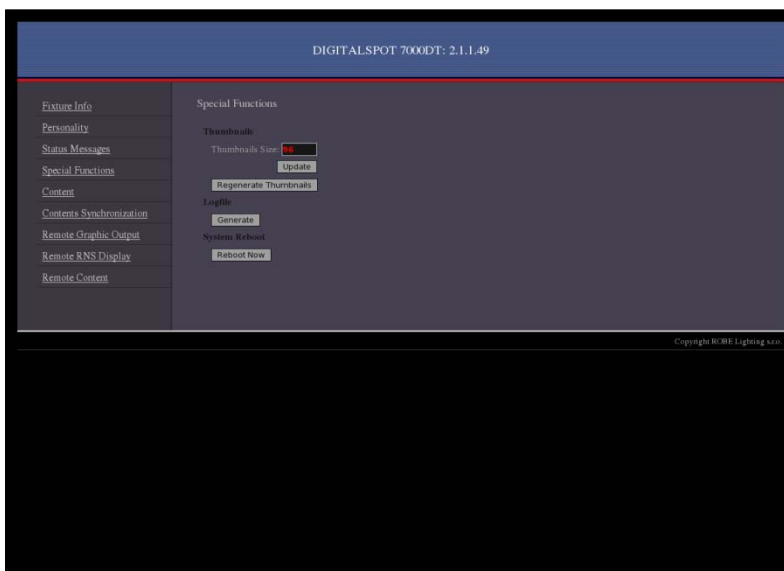

DigitalSpot 7000 DT

Content - by entering this window a complete overview of all gobo folders is offered, from which the folder to be view can be selected. Click a desired folder to display its content. Click a desired picture to zoom it in.

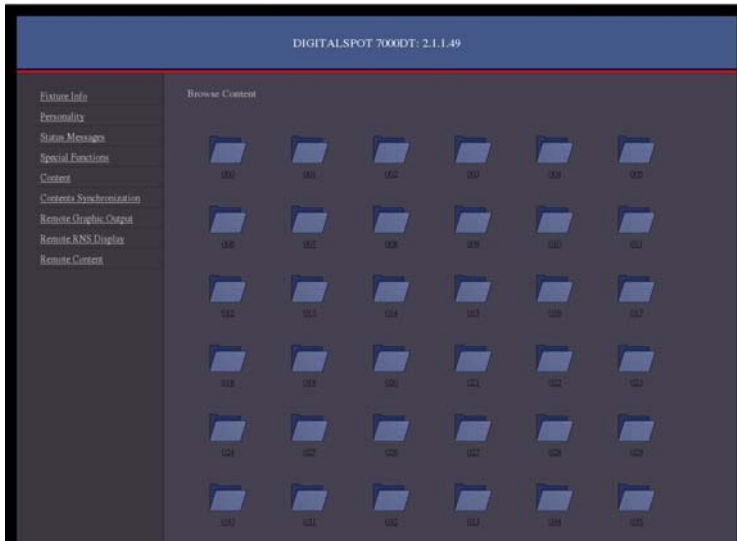

Contents Synchronization - the window allows you copy (addition) media content from a current fixture to another fixtures on an ethernet network.

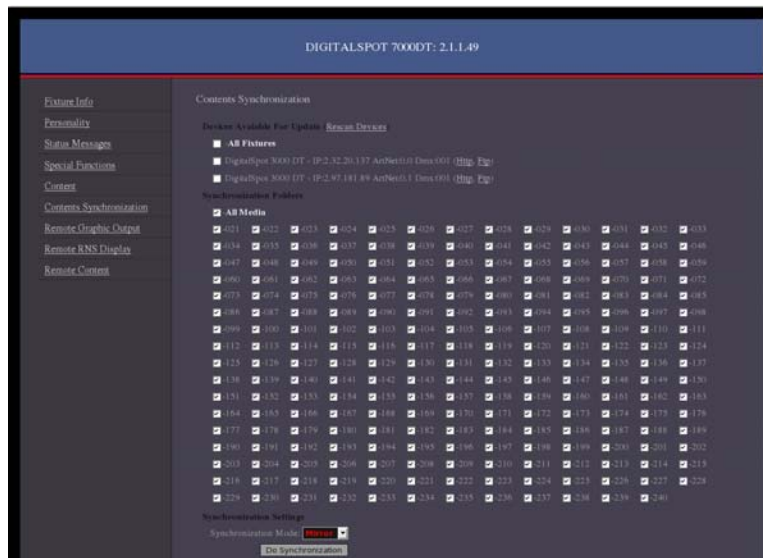

There is a list of available fixtures under **Device Available for Update**. If you connect another fixture to a network, use option "**Rescan Devices**" to refresh the list of fixtures.

A list of available folders with their check boxes is placed under **Synchronization Folders**.

Option "**Synchronization Mode**" gives you possibility to select the way how the files will be moved to target folder:

"Mirror"- a content of the target folder will be fully overwritten by a content of the source folder.

"Add"- files from the source folder are added to existing files in the target folder.

The last folder "**Update**" next to the gobo folder no. 240 serves for a synchronization of the "update" folders between the fixtures.

To move files.

1. Select desired folders check boxes. If you want to select all folders, check "All Media" check box.
2. Select a target fixture (fixtures) in a list of available fixtures.
3. Select desired Synchronization mode and click the "Do Synchronization" button to start file transfer.

Remote Graphics Output - preview of the current projecting output.

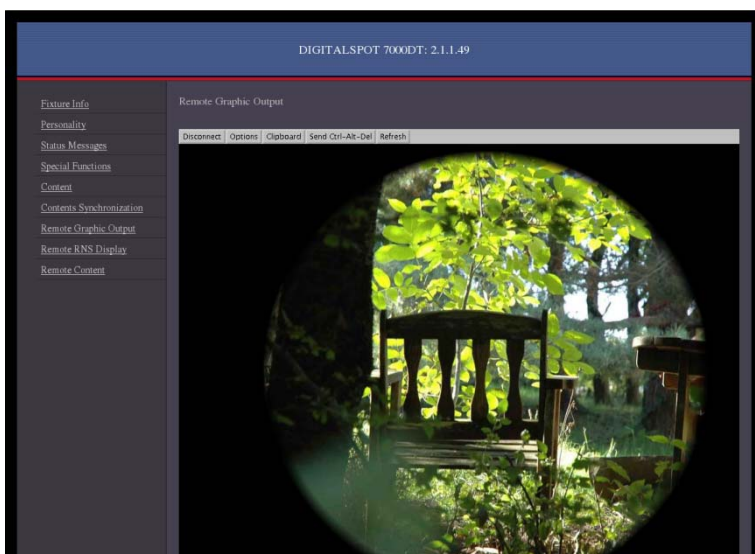

Remote RNS Display - the window "takes" the fixture's control panel. You can browse and adjust all items in this fixture menu by means of your keyboard. Use the Up/Down and Enter/Escape keys.



Remote Content - the window offers a table for definition of streaming sources. Type a streaming protocol, an IP address and a port number for the desired streaming source (e.g. laptop) to the first line in the following format: **http://2.x.x.x:port number** (for example **http://2.1.1.3:1234**) and click the "Update" button on the right side of the line to save the streaming source address. This source is assigned to the DMX value of 1 on channel "Gobo selection". Up to 20 streaming sources is possible to define in this way.

All defined streaming sources are assigned to DMX values of the **Gobo selection** channel and can be used on each gobo layer.

Previous channel **Gobo folder selection** has to be set at DMX value of 252 in order to allow the use of streaming sources assigned to the **Gobo selection** channel. See the chapter Streaming video.



To end the Remote control program, close WWW browser (or use option "**Logout**" if you entered the program using the user name and password).

23. Picture merging

The picture merging system allows to create a panoramic projection controlled from a light DMX console. The resulting seamless image consists of the images of the individual projectors. It is possible to create an image field up to 64 segments (non-mirrored configuration).

You can display the original DigitalSpot 7000 DT gobos/videos or custom gobos/videos from user folders.

23.1 Picture merging control channels

Global effect 1

DMX values in a range of 1-7 enable the picture merging procedure. You can select from several predefined widths of the picture overlapping edges (from 0 to 35%). In many cases the projection screen is smaller than the total merged image of the projectors. This total image can be scaled either using Keystoning parameters or, (better) adjusting the width of blending areas.

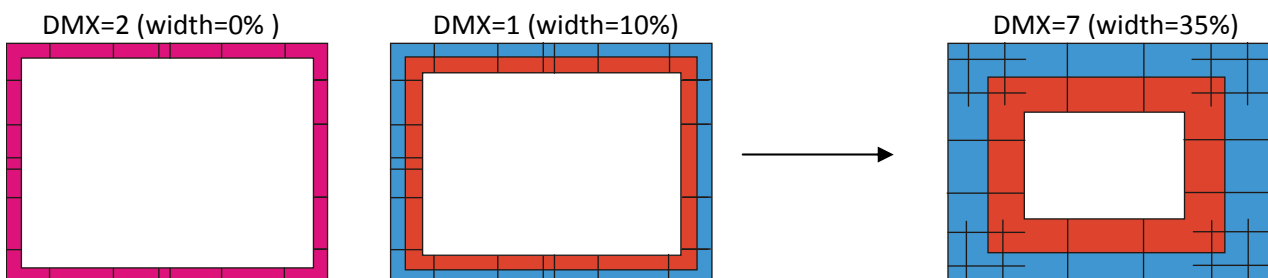

Global effect 1- Parameter 1

The DMX value from the range of 1- 235 allows selection of desired image field configuration according to the tables on the following pages.

DigitalSpot 7000 DT

Image field configuration

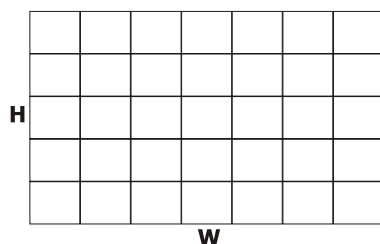

Non-mirrored configuration

DMX value	Image field Configuration W x H	Total number of fixtures	DMX value	Image field Configuration W x H	Total number of fixtures
1	2 x 1	2	56	4 x 8	32
2	1 x 2	2	57	8 x 5	40
2	2 x 2	4	58	5 x 8	40
4	3 x 1	3	59	8 x 6	48
5	1 x 3	3	60	6 x 8	48
6	3 x 2	6	61	8 x 7	56
7	2 x 3	6	62	7 x 8	56
8	3 x 3	9	63	8 x 8	64
9	4 x 1	4	64	9 x 1	9
10	1 x 4	4	65	1 x 9	9
11	4 x 2	8	66	9 x 2	18
12	2 x 4	8	67	2 x 9	18
13	4 x 3	12	68	9 x 3	27
14	3 x 4	12	69	3 x 9	97
15	4 x 4	16	70	9 x 4	36
16	5 x 1	5	71	4 x 9	36
17	1 x 5	5	72	9 x 5	45
18	5 x 2	10	73	5 x 9	45
19	2 x 5	10	74	9 x 6	54
20	5 x 3	15	75	6 x 9	54
21	3 x 5	15	76	9 x 7	63
22	5 x 4	20	77	7 x 9	63
23	4 x 5	20	78	10 x 1	10
24	5 x 5	25	79	1 x 10	10
25	6 x 1	6	80	10 x 2	20
26	1 x 6	6	81	2 x 10	20
27	6 x 2	12	82	10 x 3	30
28	2 x 6	12	83	3 x 10	30
29	6 x 3	18	84	10 x 4	40
30	3 x 6	18	85	4 x 10	40
31	6 x 4	24	86	10 x 5	50
32	4 x 6	24	87	5 x 10	50
33	6 x 5	30	88	10 x 6	60
34	5 x 6	30	89	6 x 10	60
35	6 x 6	36	90	11 x 1	11
36	7 x 1	7	91	1 x 11	11

DMX value	Image field Configuration W x H	Total number of fixtures	DMX value	Image field Configuration W x H	Total number of fixtures
38	7 x 2	14	93	2 x 11	22
39	2 x 7	14	94	11 x 3	33
40	7 x 3	21	95	3 x 11	33
41	3 x 7	21	96	11 x 4	44
42	7 x 4	28	97	4 x 11	44
43	4 x 7	28	98	11 x 5	55
44	7 x 5	35	99	5 x 11	55
45	5 x 7	35	100	12 x 1	12
46	7 x 6	42	101	1 x 12	12
47	6 x 7	42	102	12 x 2	24
48	7 x 7	49	103	2 x 12	24
49	8 x 1	8	104	12 x 3	36
50	1 x 8	8	105	3 x 12	36
51	8 x 2	16	106	12 x 4	48
52	2 x 8	16	107	4 x 12	48
53	8 x 3	24	108	12 x 5	60
54	3 x 8	24	109	5 x 12	60
55	8 x 4	32	-	-	-

Example

Image field configuration:

W x H = 2 x 2 = 4 projectors

DMX= 3

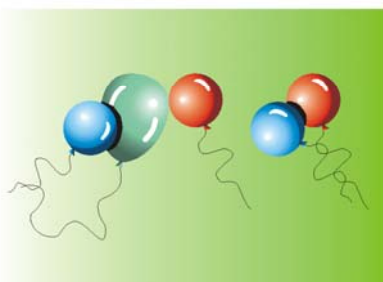
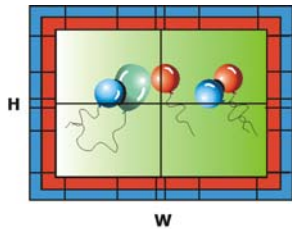

W x H = 4 x 4 = 16 projectors

DMX=15

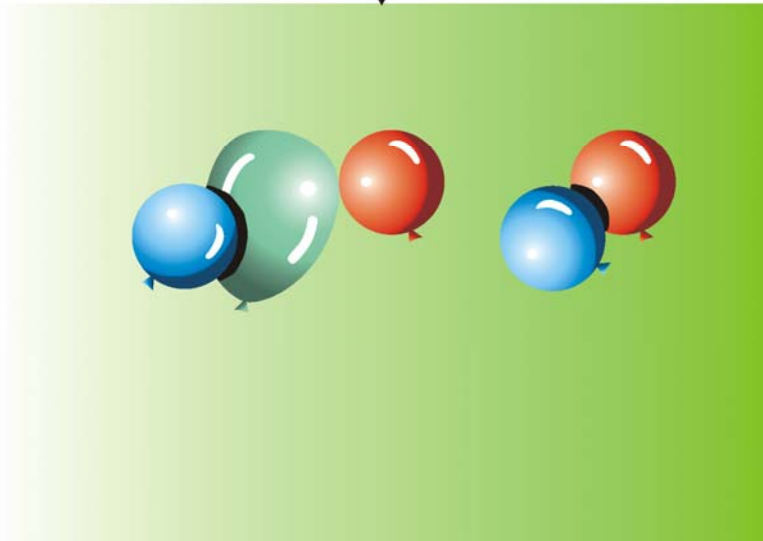
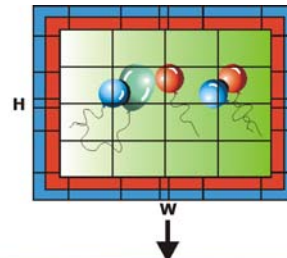

Horizontally mirrored configuration

DMX value	Image field configuration of base matrix W x H	Total number of fixtures in base matrix	DMX value	Image field configuration of base matrix W x H	Total number of fixtures in base matrix
128	2 x 1	2	146	10 x 2	20
129	4 x 1	4	147	4 x 5	20
130	2 x 2	4	148	10 x 3	30
131	4 x 2	8	149	6 x 5	30
132	6 x 1	6	150	10 x 4	40
133	2 x 3	6	151	8 x 5	40
134	6 x 2	12	152	10 x 5	50
135	4 x 3	12	153	12 x 1	12
136	6 x 3	18	154	2 x 6	12
137	8 x 1	8	155	12 x 2	24
138	2 x 4	8	156	4 x 6	24
139	8 x 2	16	157	12 x 3	36
140	4 x 4	16	158	6 x 6	36
141	8 x 3	24	159	12 x 4	48
142	6 x 4	24	160	8 x 6	48
143	8 x 4	32	161	12 x 5	60
144	10 x 1	10	162	10 x 6	60
145	2 x 5	10	163	12 x 6	72

Example

Image field configuration:

W x H = 2 x 2 = 4 projectors

DMX= 130

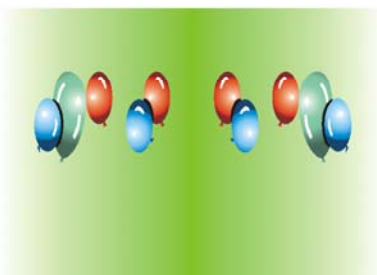
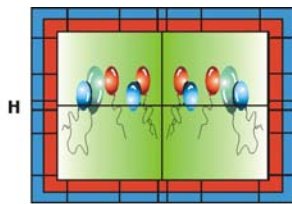

W x H = 4 x 4 = 16 projectors

DMX=140

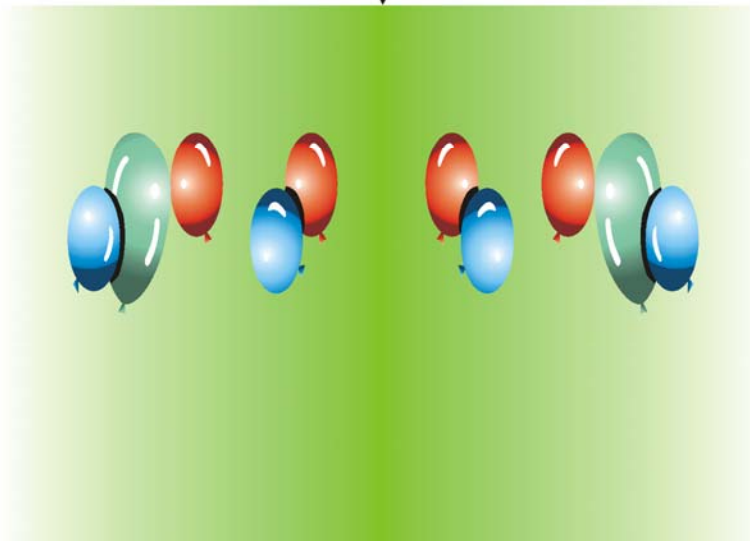
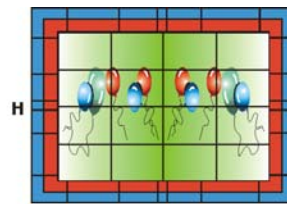

Vertically mirrored configuration

DMX value	Image field configuration of base matrix W x H	Total number of fixtures in base matrix	DMX value	Image field configuration of base matrix W x H	Total number of fixtures in base matrix
164	1 x 2	2	182	5 x 4	20
165	2 x 2	4	183	2 x 10	20
166	1 x 4	4	184	5 x 6	30
167	2 x 4	8	185	3 x 10	30
168	3 x 2	6	186	5 x 8	40
169	1 x 6	6	187	4 x 10	40
170	3 x 4	12	188	5 x 10	50
171	2 x 6	12	189	6 x 2	12
172	3 x 6	18	190	1 x 12	12
173	4 x 2	8	191	6 x 4	24
174	1 x 8	8	192	2 x 12	24
175	4 x 4	16	193	6 x 6	36
176	2 x 8	16	194	3 x 12	36
177	4 x 6	24	195	6 x 8	48
178	3 x 8	24	196	4 x 12	48
179	4 x 8	32	197	6 x 10	60
180	5 x 2	10	198	5 x 12	60
181	1 x 10	10	199	6 x 12	72

Example

Image field configuration:

W x H = 2 x 2 = 4 projectors

DMX= 165

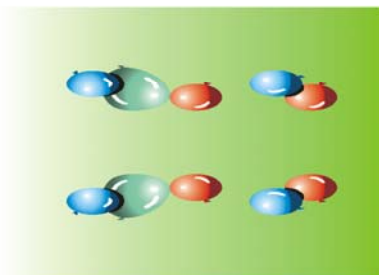
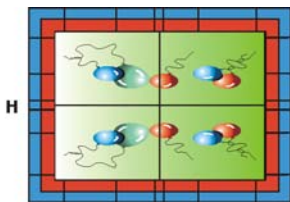

W x H = 4 x 4 = 16 projectors

DMX=175

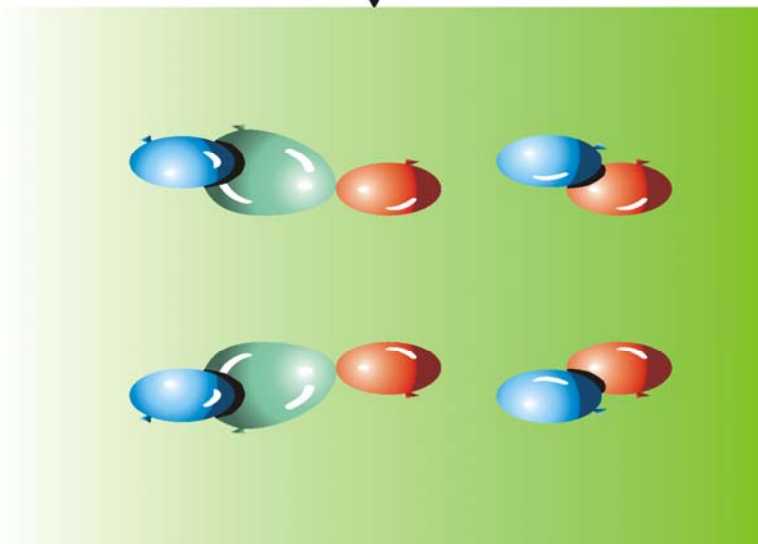
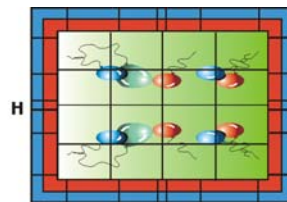

Vertically and horizontally mirrored configuration

DMX value	Image field configuration of base matrix W x H	Total number of fixtures in base matrix	DMX value	Image field configuration of base matrix W x H	Total number of fixtures in base matrix
200	2 x 2	4	218	10 x 4	40
201	4 x 2	8	219	4 x 10	40
202	2 x 4	8	220	10 x 6	60
203	4 x 4	16	221	6 x 10	60
204	6 x 2	12	222	10 x 8	80
205	2 x 6	12	223	8 x 10	80
206	6 x 4	24	224	10 x 10	100
207	4 x 6	24	225	12 x 2	24
208	6 x 6	36	226	2 x 12	24
209	8 x 2	16	227	12 x 4	48
210	2 x 8	16	228	4 x 12	48
211	8 x 4	32	229	12 x 6	72
212	4 x 8	32	230	6 x 12	72
213	8 x 6	48	231	12 x 8	96
214	6 x 8	48	232	8 x 12	96
215	8 x 8	64	233	12 x 10	120
216	10 x 2	20	234	10 x 12	120
217	2 x 10	20	235	12 x 12	144

Example

Image field configuration:

W x H = 2 x 2 = 4 projectors

DMX= 200

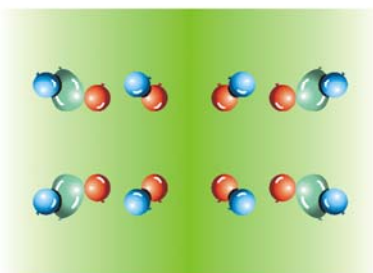
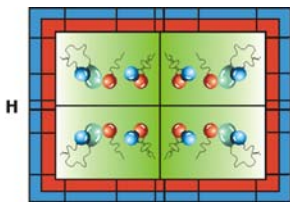

W x H = 4 x 4 = 16 projectors

DMX=203

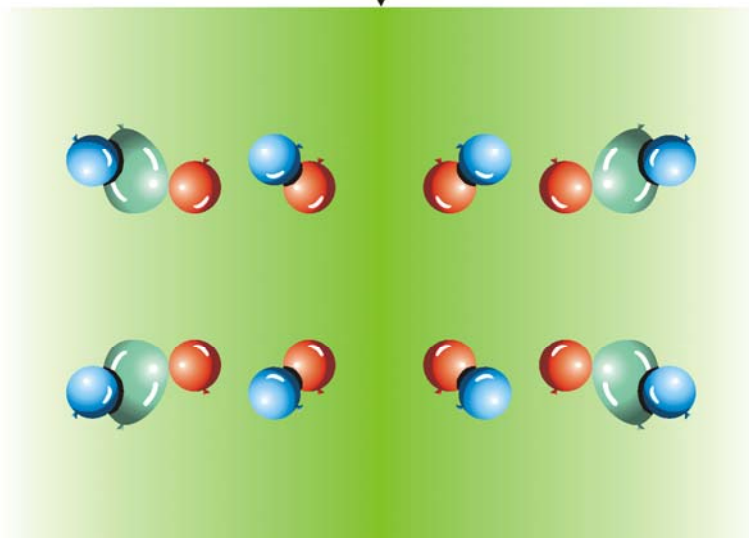
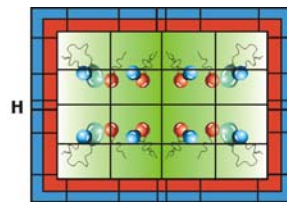

The mirrored image configurations bring 2 advantages:

1. Resolution of the source image and merged images on the wall is the same in comparison with non-mirrored configuration (if you use suitable mirrored configuration – see example 3 below).
2. By using the picture merging with mirrored configuration you can cover any size of projection area. The total number of used projectors is unlimited.

Examples: 4 DigitalSpots 7000DT are used in the picture merging.

Source picture

Aspect ratio: 4:3

Resolution: 1024 x 768

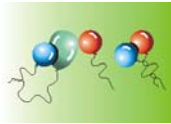

Images on the wall:

Example 1. Horizontally mirrored configuration 4 x 1 (DMX=129) set on all fixtures

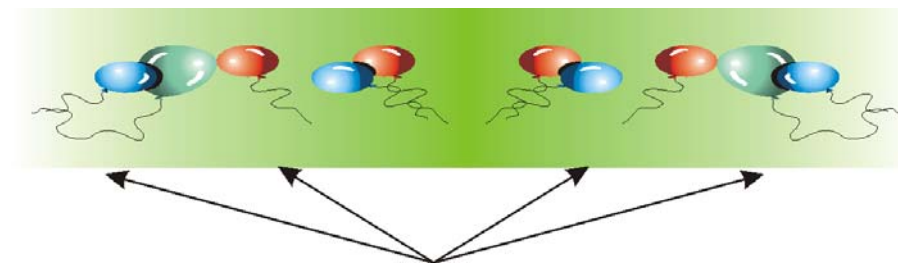

All projected images have a resolution of 1024 x 768, but the resolution of 1024 pixels is “made” from 512 pixels as each fixture projects 1/2 of the source picture (this half has a source resolution 512 x 768).

Example 2. Horizontally mirrored configuration 2 x 1 (DMX=128) set on two pairs of fixtures

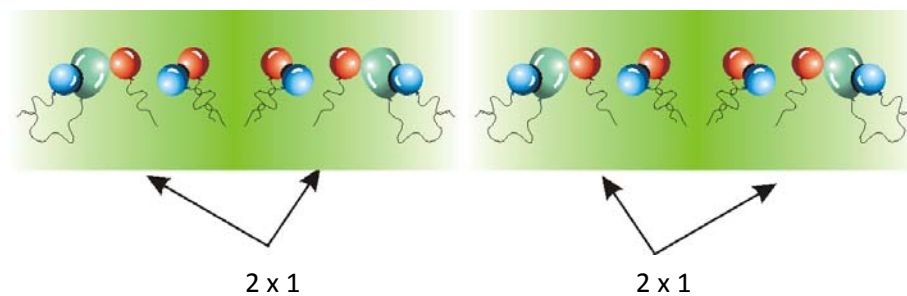

All projected images have a resolution of 1024 x 768 pixels and the total image does not have any distortion (horizontally or vertically). The base matrix 2 x 1 is twice repeated.

Example 3. Non- mirrored configuration 4 x 1 (DMX=9) set on all fixtures

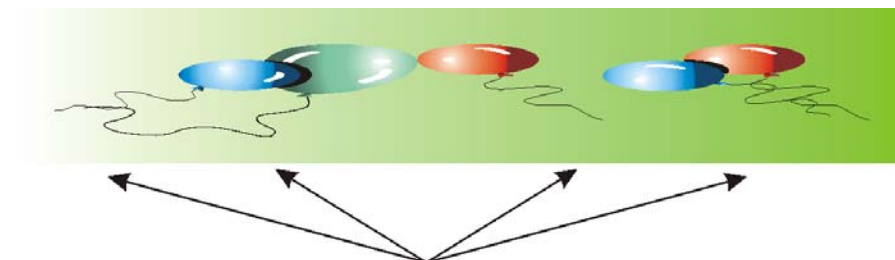

All projected images have resolution 1024 x 768, but the resolution of 1024 pixels is “made” from 256 pixels as each fixture projects ¼ of the source picture (this quarter has a source resolution 256 x 768).

Global effect 1- Parameter 2

The DMX values from the range of 0-255 are used to step segment by segment throw the image grid. The DMX value of 0 corresponds to the upper left segment of the image grid. The stepping runs from the left to the right and down from top (see example for field 8x3 segments below).

DMX=0 Segment 1	Segment 2	Segment 3	Segment 4	Segment 5	Segment 6	Segment 7	Segment 8
DMX=8 Segment 9	Segment 10	Segment 11	Segment 12	Segment 13	Segment 14	Segment 15	Segment 16
DMX=16 Segment 17	Segment 18	Segment 19	Segment 20	Segment 21	Segment 22	Segment 23	Segment 24

Global effect 1- Parameter 3

This channel enables to transform displaying of the segment edges-sharp or blended edges. You can also display the blue and red auxiliary frame with the alignment marks for easier alignment of the adjacent segments:

Channel	Value	Type of control	Type of control
53	0-130	Global effect 1 - Parameter 3	
	131-141	Displays segment with blended edges (active keystoneing)	step
	142-150	Displays segment with sharp edges (active keystoneing)	step
	151-160	Displays segment with sharp edges	step
	161-171	Displays auxiliary patern frame with sharp edges (active keystoneing)	step
	172-255	Reserved	step

To align segments use pan/tilt, zoom and keystone channels.

Segments before alignment:

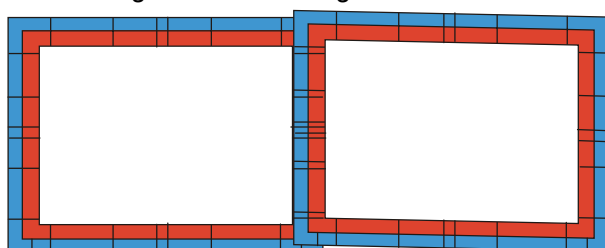

Segments after alignment:

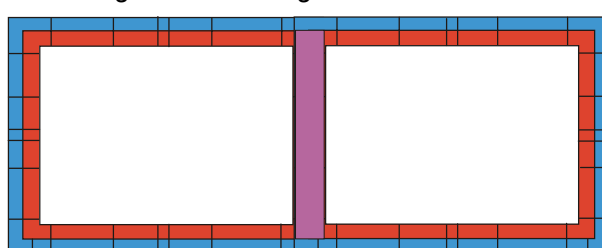

At adjacent edges, there is the blue edge that overlaps the red one and respectively :

Note. DMX values of both channels **Global effect 1** and **Global effect 1- Parameter 1** have to be set at the same values on all fixtures used in the picture merging.

Global effect 2

A DMX value of 20 enables fine adjusting of the red, green and blue gamma curve at overlapping edges to achieve consistent colour (brightness) of these parts of image.

Note. After selecting desired image segment for the gamma correction (by means of the **Global effect 1 - Parameter 2**), set the channel **Global effect 1 - Parameter 3** to 0 in order to display blended edges of the picture segment.

Global effect 2- Parameter 1

The parameter adjust the red gamma value at respective image edge.

Global effect 2- Parameter 2

The parameter adjust the green gamma value at respective image adge.

Global effect 2- Parameter 3

The parameter adjust the blue gamma value at respective image adge.

23.2 Picture merging example

Here is an example of the image field 3x2.

1. All fixtures that are a part of the picture merging should have a different fixture ID (**The fixture ID= the last number of its IP address**). The fixture's IP address consists of four numbers separated by the dot e.g. 002.168.002.**010**.
2. Select the same gobo/video on the six DigitalSpots 7000 DT.
3. On all fixtures you are configuring set a DMX value=1 at the channel **Global Effect 1**.
On all fixtures you are configuring set a DMX value=6 at the channel **Global Effect 1-Parameter 1**.
4. Set a DMX value at the channel **Global Effect 1- Parameter 3** between 151-160 to define a sharp edges of segments for a fine alignment.
5. On each individual fixture set a DMX value between 0-5 at **Global Effect 1 - Parameter 2** to select the segment that the fixture will project.
6. Use pan/tilt/zoom and keystone channels to align the projections of individual fixtures in such a way that there is some overlap between the separate portions of the image. This overlap is necessary for the picture merging adjustment.
7. Set a DMX value at **Global Effect 1- Parameter 3** between 131-141 to display the segment with sharp edges for fine adjustment by means the fine pan/tilt and keystones channels. After it set this parameter to 0 and the channel **Global Effect 2** set to 20 to enable fine RGB gamma correction by means of the **Global Effect 2 – Parameter 1-3**.
8. To execute the picture merging ,run the same gobo/video on all six fixtures and set the channels **Global Effect 1-Parameter 3** to a DMX value of 0-130.

Note: In order to assure a correct playback of videos sequences , all fixtures in the picture merging system should be synchronized to the one (master) fixture - see the chapter bellow.

24. Pre-cut content mode for Picture Merging

The mode is useful when you want to cover large projection area with full resolution for each projector or you don't want to be restricted with limits of matrix configuration.

The basic idea is that before projection you have to prepare the pre-cut content (e.g. picture) and upload the single parts of the splitted source picture into individual fixtures.

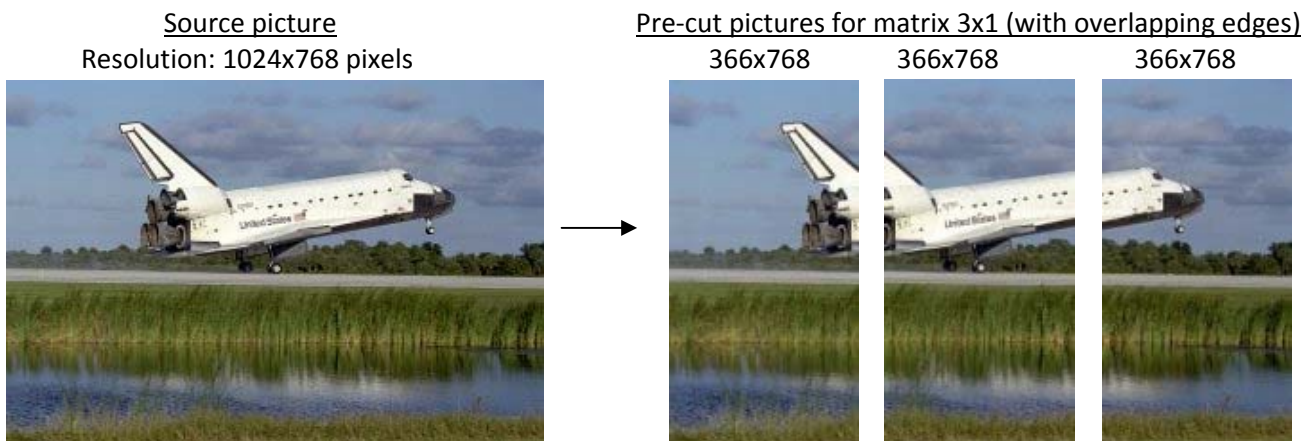

Single segments of the source picture must have the same size (pixels) which is given by:

$$L_{partX} = L_{totalX} / [x - (b/100) * (x-1)] \quad \text{..... Size of the single segment in X-axis}$$

$$L_{partY} = L_{totalY} / [y - (b/100) * (y-1)] \quad \text{..... Size of the single segment in Y-axis}$$

where

L_{partX} = size (pixels) of picture segment in X-axis

L_{partY} = size (pixels) of picture segment in Y-axis

L_{totalX} = total size (pixels) of the source picture in X-axis

L_{totalY} = total size (pixels) of the source picture in Y-axis

x = number of picture segments in X-axis

y = number of picture segments in Y-axis

b = size of overlapping edges in %

Positions at which single picture segments start in the source picture are given by:

$$L_{posX} = (N_x - 1) * L_{partX} * [1.0 - (b/100)] \quad \text{..... Position in X-axis}$$

$$L_{posY} = (N_y - 1) * L_{partY} * [1.0 - (b/100)] \quad \text{..... Position in Y-axis}$$

where

L_{posX} = position (pixels) at which segment starts in X-axis

L_{posY} = position (pixels) at which segment starts in Y-axis

N_x = order of the fixture image in X-axis (figured from the left side of the source picture)

N_y = order of the fixture image in Y-axis (figured from the bottom side of the source picture)

b = size of overlapping edges in %

The pre-cut content mode has several advantages compared to the standard picture merging:

- unlimited size of the image field configuration matrix
- allows full resolution of every matrix element
- less loading of fixtures ´graphics engines

But the time for preparing pictures and calculation of the overlapping edges has to be taken into account.

There is an example of calculation of needed points in the source fixture for the image stated above.

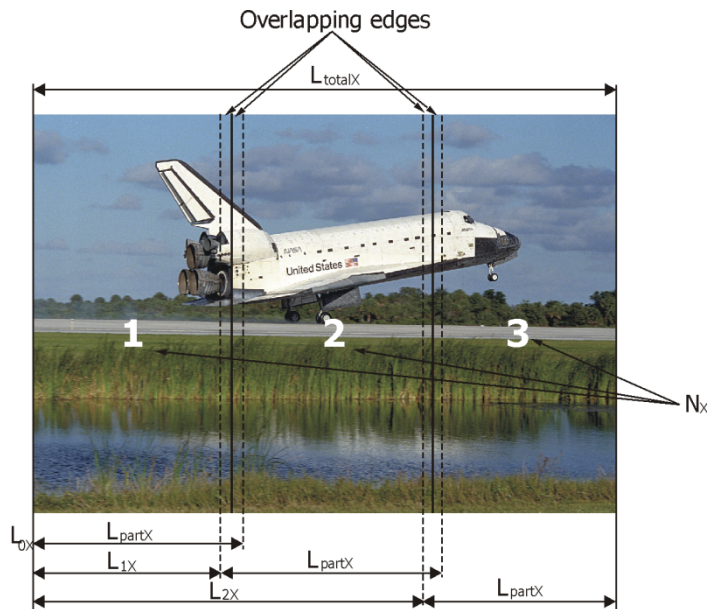

Size of segments in X-axis: $L_{partX} = L_{totalX} / [x - (b/100) * (x-1)]$

$$L_{partX} = 1024 / [3 - (10/100) * (3-1)] \quad \text{the size of overlapping edges was selected 10% (b=10)}$$

$$L_{partX} = 366 \text{ pixels}$$

Since the size of the segments in Y-axis is the same as at the source picture, each of the 3 fixtures will project picture with resolution of 366x768 pixels.

Note. On the other way round, if you need to calculate the resolution of the source picture to ensure that every fixture will use the resolution of 1024x768 pixels, use the formula:

$$L_{totalX} = L_{partX} * [x - (b/100) * (x-1)]$$

for this case: $L_{totalX} = 1024 * [3 - (10/100) * (3-1)]$ $L_{partX} = 1024 \text{ pixels}$
 $L_{totalX} = 2867 \text{ pixels}$

The source picture should have min. resolution of 2867x768 pixels.

Positions in X-axis at which single picture segments start:

$$L_{posX} = (N_x - 1) * L_{partX} * [1.0 - (b/100)]$$

For the segment 1: $L_{0X} = (1-1) * 366 * [1.0 - (10/100)] = 0 \text{ pixels}$ $N_x = 1$

For the segment 2: $L_{1X} = (2-1) * 366 * [1.0 - (10/100)] = 329 \text{ pixels}$ $N_x = 2$

For the segment 3: $L_{2X} = (3-1) * 366 * [1.0 - (10/100)] = 659 \text{ pixels}$ $N_x = 3$

Result: The first picture segment starts at point 0 pixels and has resolution of 366x768 pixels.

The second picture segment starts at point 329 pixels and has resolution of 366x768 pixels.

The third picture segment starts at point 659 pixels and has resolution of 366x768 pixels.

Using a suitable software you have to prepare these three pictures and copy them to the individual fixtures in order to use them in the picture merging procedure. On the channel **Global Effect 1** select a DMX value from the range of 11-17 DMX according as large overlapping edges you have calculated. All other settings are the same as for standard picture merging operation.

Note. For correct video files synchronization you have to ensure that all cutted video segments must have the same times of video lasting.

25. Effect video synchronization

The synchronization option can be set separately for each gobo layer (channels **Synchronization to ID**). The fixture synchronization acts with the fixture ID which is defined as the last number of fixture's IP address. This fixture ID is shown on the fixture's display. The fixtures are synchronized to the one fixture - named a master fixture.

The fixtures may be controlled by the DMX but the fixture synchronization runs over ethernet network - it means that all fixtures that are to be synchronized have to be connected to the ethernet.

Each DMX value of the synchronizing channel responds to the fixture ID of a certain fixture.

You have to set the DMX value (ID) of the master fixture on all fixtures that are to be synchronized. If the DMX value = fixture ID, in this case the fixture is set as a master.

Example: 4 DigitalSpots 7000 DT which are synchronized through the gobo layer 1 to the fixture 3 :

	IP address	Fixture ID	Synchronization to ID (Channel 85)	
Fixture 1	002.168.002.010	10	DMX=20	
Fixture 2	002.168.002.015	15	DMX=20	
Fixture 3	002.168.002. 020	20	DMX=20	Master fixture
Fixture 4	002.168.002.021	21	DMX=20	

Note: For a synchronous video projection on the layer 1, the channels **InFrame High, In Frame Low, Out Frame High, Out frame Low, Gobo control, Playback Speed** have to be set at the same values on all fixtures. The same rule proceeds for the gobo layer 2, 3 and 4.

26. Projection onto angular, cylindric or spheric surfaces

If a projection on curved surface is required a correction of the shape distortions is necessary. The DigitalSpot 7000 DT supports projection onto angular screens, cylinders and spheres.

26.1 Curved surface support channels

Global effect 2

This channel enables you to select desired shape of the surface:

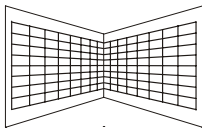
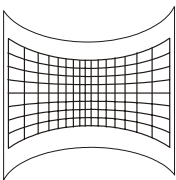
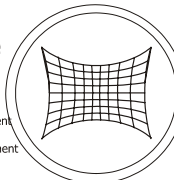
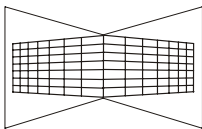
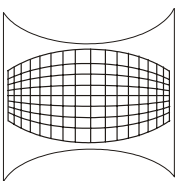
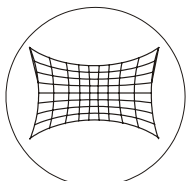
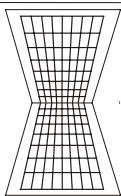
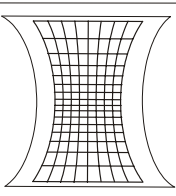
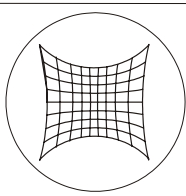
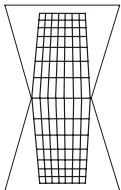
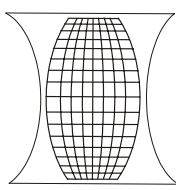
DMX Value	Surface	DMX Value	Surface	DMX Value	Surface
1	Vertical inside corner (opening towards fixture) 	5	Vertical convex cylinder (opening towards fixture) 	9	Orthographic sphere mapping Note: parameter 1 range: 0-127 - convex surface adjustment 128 - no adjustment (default) 129-255 - concave surface adjustment 
2	Vertical outside corner (opening away from fixture) 	6	Vertical concave cylinder (opening away from fixture) 	10	Rectangle to circle (sphere) Note: Keystone parameters have a different meaning 
3	Horizontal inside corner (opening towards fixture) 	7	Horizontal convex cylinder (opening towards fixture) 	11	Square to circle (sphere) Note: Keystone parameters have a different meaning 
4	Horizontal outside corner (opening away from fixture) 	8	Horizontal concave cylinder (opening away from fixture) 		

To simplify a correction process, there is a gobo with a net pattern (DMX value = 2) in a factory folder No. 20 (DMX value= 20) on a Gobo folder selection channel each gobo layer.

Global effect 2- parameter 1

This parameter enables to adjust the total length of the image edge. A value of 0 means no adjustment, a value of 255 means maximum correction.

Note. If a corner projection is selected on a **Global effect 1** (values of 1-4), the red guiding line will appear in the image (the gobo with the net pattern has to be projected).

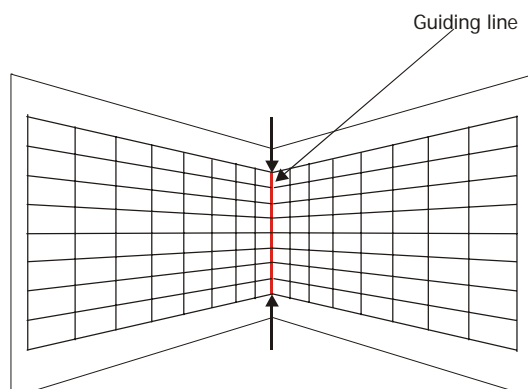

Global effect 2- parameter 2

This parameter enables to adjust the horizontal length of the edge. A DMX Value of 128 = no adjustment, values below 128 move the edge to the left, values above 128 move the edge to the right.

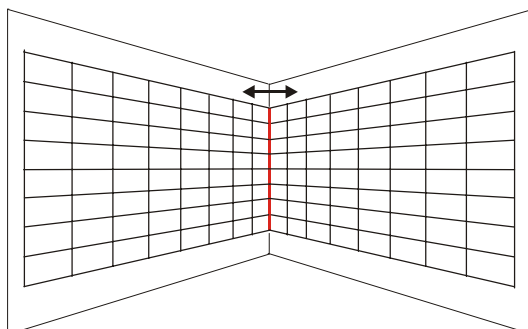

Global effect 2- parameter 3

This parameter enables to adjust the vertical length of the edge. A DMX Value of 128 = no adjustment, values below 128 move the edge downwards, values above 128 move the edge upwards.

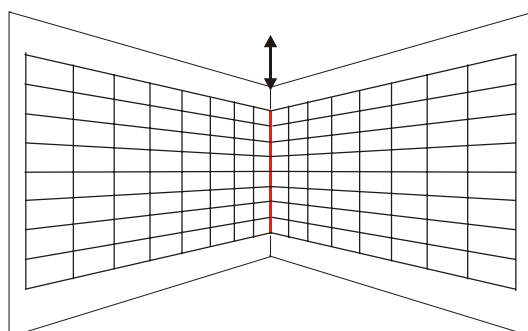

These global effect 2 parameters 1-3 have to be used in combination with the KeyStone and KeyStone X-ratio (Y-ratio) parameters to adjust desired shape of image.

Corner projection

Example:

1. Project the gobo with a net pattern on the wall (the channel **Gobo Folder selection** ,is set at a value of 20 ,the channel **Gobo selection** at a value of 2).
2. Set the channel **Global Effect 2** to a Horizontal inside corner mapping (DMX value=3)
3. Use the channel **Global Effect 2 -Parameter 1** to adjust the length of the image edge.
4. Use the channels **Global Effect 2 -Parameter 2**, and **Global Effect 2 -Parameter 3** and Keystone channels to correct image on the wall.
5. Use the **KeyStone Y-ratio** channel for the final correction of the image.

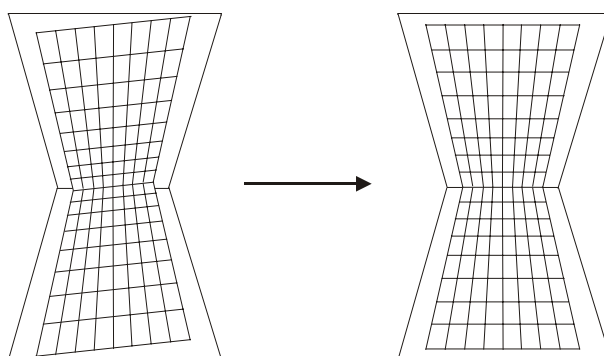

Note:

If a projection of rectangle (square) on a circle (sphere) is selected on the channel **Global Effect 2** (DMX value of 10 or 11), the meaning of the Keystone parameters in a DMX chart will be changed as follows:

Channel	DMX value	Function	Type of control
23	0 -127 128 129-255	Image moving in an X-direction Moving the image from left to center Center Moving the image from center to right	proportional step proportional
24	0 -127 128 129-255	Image moving in a Y-direction Moving the image from bottom to center Center Moving the image from center to top	proportional step proportional
25	0 - 255	Squeezing in an X-direction Continual squeezing	proportional
26	0 - 255	Squeezing in a Y-direction Continual squeezing	proportional
27	0 - 255	Squeezing in a diagonal direction (top right-bottom left) Continual squeezing	proportional
28	0 - 255	Squeezing in a diagonal direction (bottom left-top right) Continual squeezing	proportional
29	0-255	Zoom Continual zooming	proportional
30	0-255	Indexing Anticlockwise indexing	proportional

26.2 Rectangle onto circle (sphere) mapping with picture merging

This effect in contrast to the effects stated above allows not only a projection onto a circle (sphere) but in addition enables a picture merging onto a circle (sphere) surface.

This effect can be activated on the the **Global Effect 2 Selection** channel at a DMX Value of 12. The **Parameter 1** of the effect changes the sphere diameter. The **Parameter 2** and **Parameter 3** correct distortion in X-axis and Y-axis due to the different projection angles of the fixtures.

There are examples for the image field configuration 2x2:

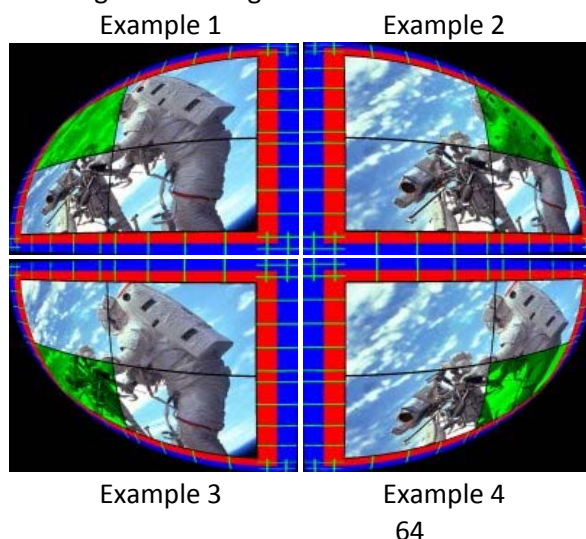

27. Video processing on gobo layers from a streaming video server

A streaming video is a video that is continuously sent by one device (e.g. PC) and received by another device (DigitalSpot 7000 DT) over an ethernet network.

The Streaming video software stated on the pictures below is available at <http://www.videolan.org/vlc/>.

Download VLC media player from this web page and install it on your streaming source (PC, notebook..).

Here are important installation points how to prepare a video processing on gobo layers from a remote streaming video source in the fixture.

Streaming source (here is an example for PC running Windows XP)

1. Download the VLC media player to the PC (Windows self-extracting package 0.8.6f),
2. Set PC network card for Art-Net network:
 - Menu path: "Start" --> "Control Panel" --> "Network Connection" --> "Connection"

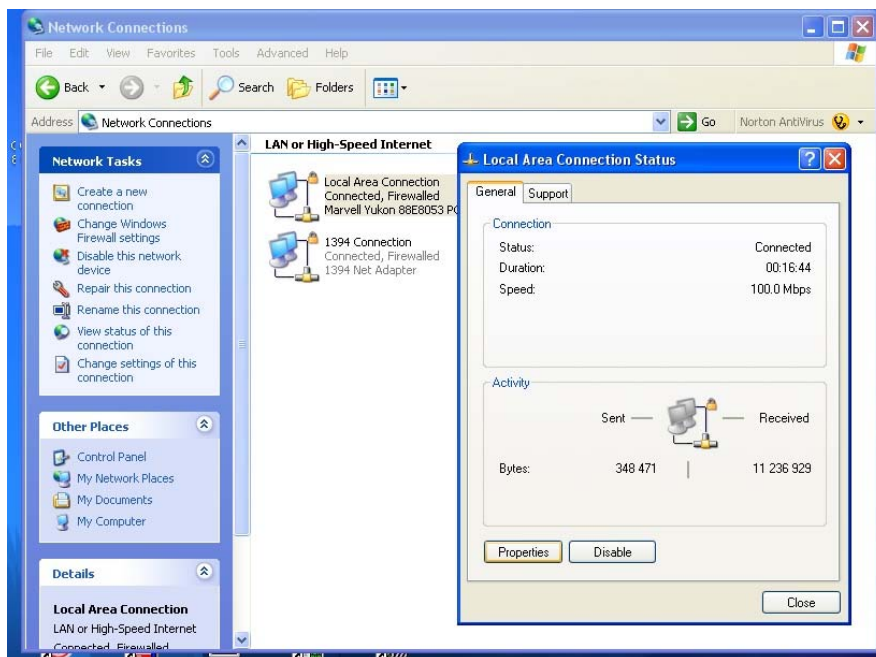

- Click on the "Properties" button and the following window will open.

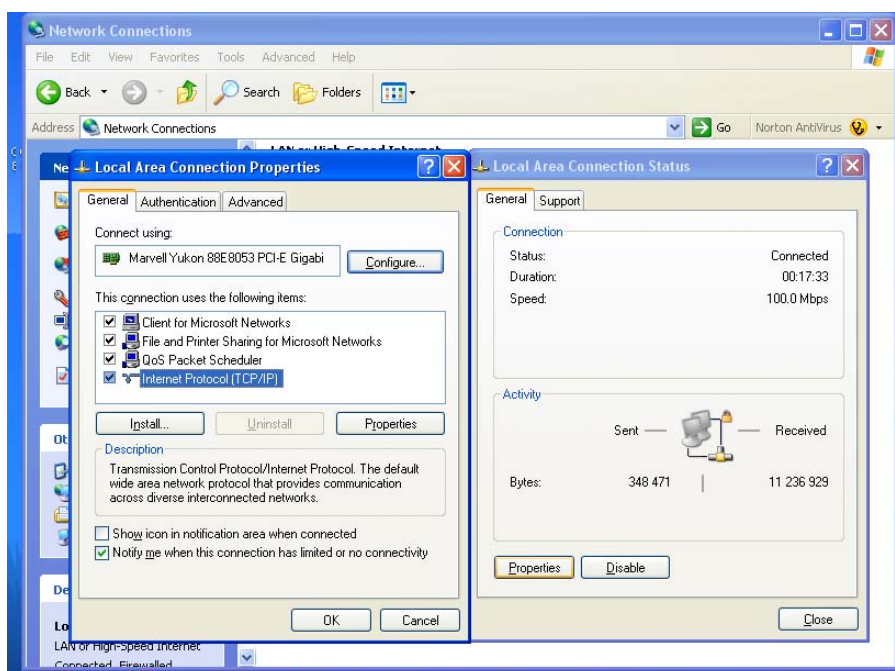

- Click on the item "Internet Protocol (TCP/IP)" and the Internet Protocol Properties window will open. Set IP address to something like 2.X.X.X with an IP mask of 255.0.0.0

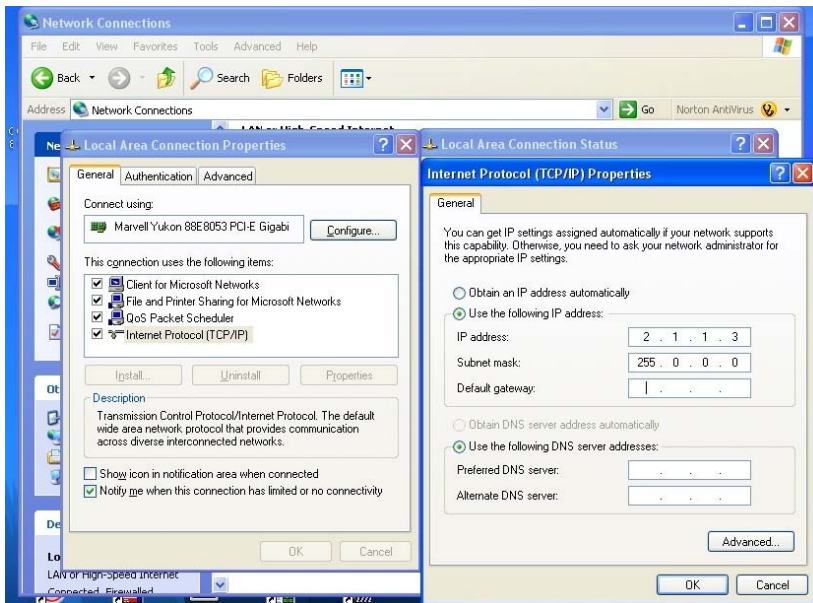

3. Install a VLC media player.

- click on a VLC media player self-extracting package located on the hard disk and follow the on-screen instructions. After installing it, run this VLC media player. In a horizontal menu "File" click on "Open" and the following window will open.

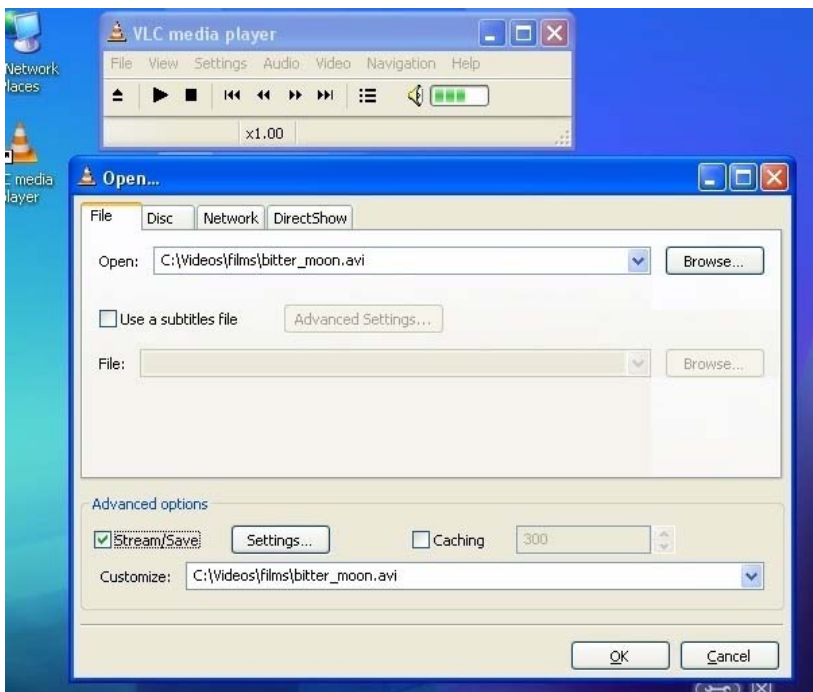

DigitalSpot 7000 DT

Type the name of video file in the "Open" field, check the "Stream/Save" option and click the "Settings" button. The "Stream output" window will open:

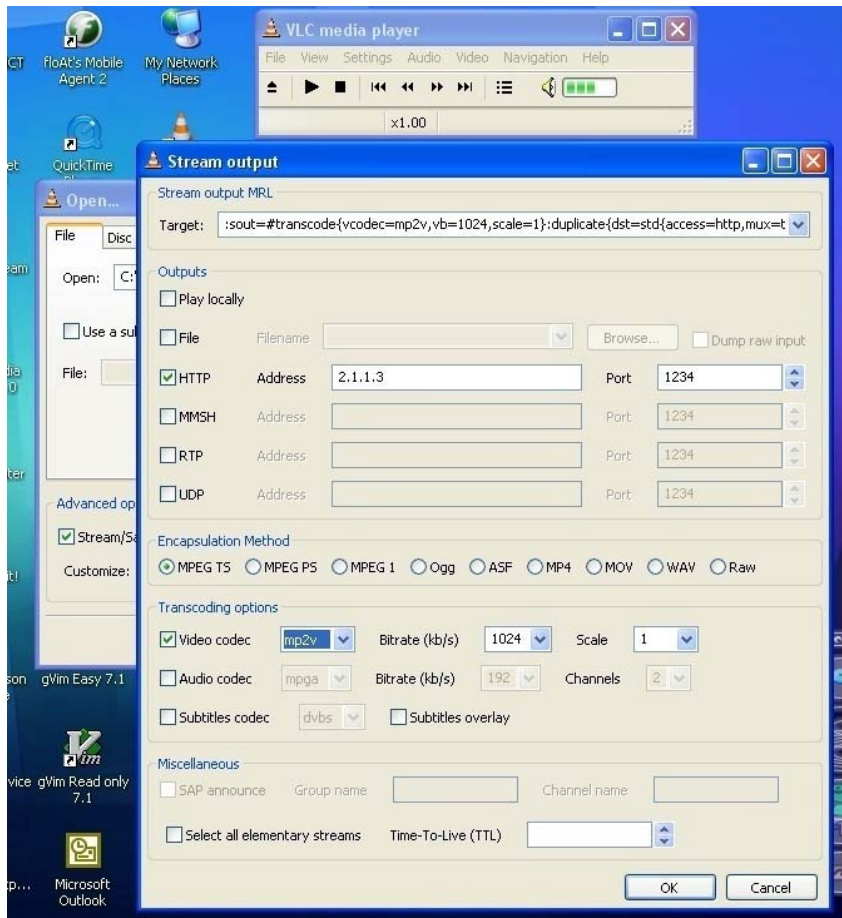

Check the "HTTP" option in a Outputs column, type an IP address of the PC in the "Address" field and a figure port in the "port" field.

Note: If you want to run more videos on this PC, you have to run the VLC media player for each video and every media player has to have a different figure of the port but the IP address will be the same.

Select the MPGTS or MPEGPS option in the "Encapsulation method" row. Check the "Video codec" option and select mp2v. In the field "Bitrate kb/s" set value of 1024 or higher.

The Bitrate is the number of kbits that are conveyed or processed per second. The higher is the number, the higher is the quality of the projected image. For streaming of desktop we recommend the bitrate of 8192.

Click the "OK" button and confirm the "Open" window.

The VLC media player is now ready for playing up the video sequences.



DigitalSpot 7000 DT

PC Desktop streaming.

The desktop streaming enables you to send your presentation directly to the DigitalSpot 7000 DT via an ethernet network. You do not need extra cables for connecting video inputs of the DigitalSpot 7000 DT with your PC.

A different setting of VLC media player for streaming of the PC desktop is required. Type the following line in the "Customize" field of the Open window:

screen:// screen-fps=10 :screen-caching=100

Space

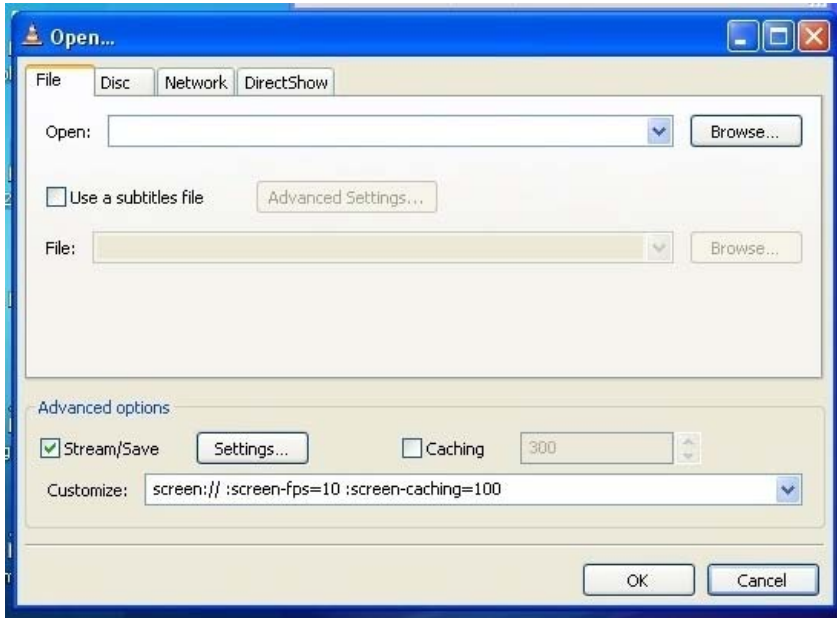

The Stream output window has the same setting like for video streaming except the field "Bitrate (kb/s)" which should be set at the value of 8192.

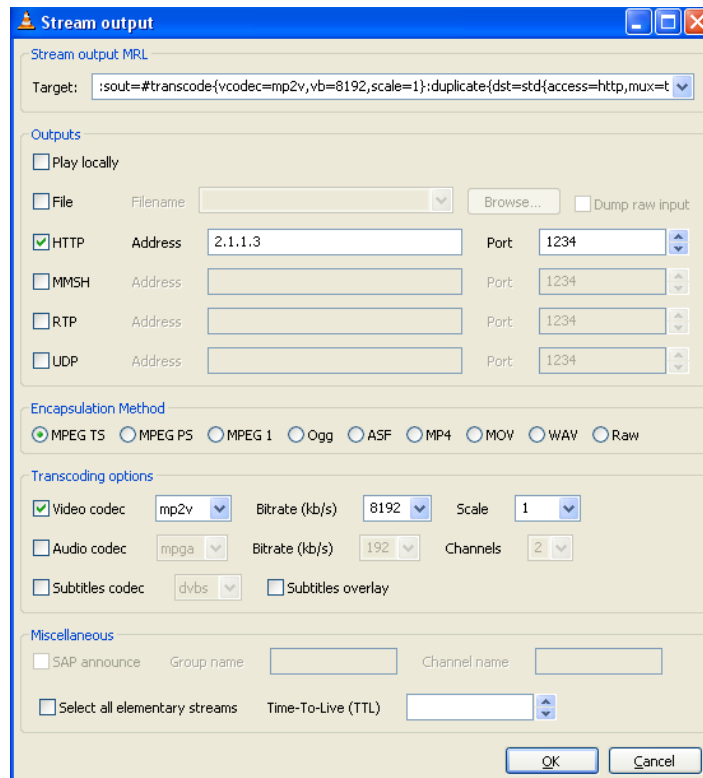

Important: The *Playback speed* channel at corresponding gobo layer should be set at a DMX value of 150-200.

Control PC (light console)

Type the IP address of the DigitalSpot 7000 DT which is to project data from a remote streaming video source in your WWW browser to run the Remote Control program.

Select the option "Remote Content" and the following window will open:

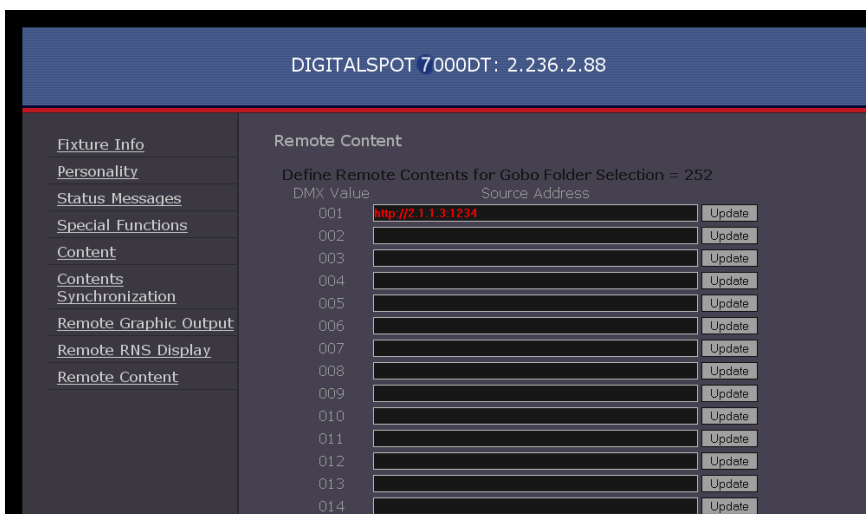

Type in the "source Address" field the IP address and the port number of the streaming source (in our case it is a PC) in this format: http://2.x.x.x:port number e.g. http://2.1.1.3:1234 and save it by clicking the "Update" button. This way defined streaming source is assigned to a DMX value of 1 at the channel **Gobo selection**.

You can define another videos from the same streaming source - the IP addresses will be the same for all videos only the port numbers have to be different.

After specifying all streaming sources close the "Remote Content" window.

To run a video processing on the fixture

On The DigitalSpot 7000 DT which is to project video data from a streaming video source, set the channel **Gobo folder selection** at value of 252 and on the following channel "Gobo selection" set a DMX value which responds to the streaming video source defined in the "Remote Content" window. The streaming video processing starts running with a delay of cca 10 seconds.

Example for gobo/video layer 1:

Channel	Value	Function	Type of control
59	0-20	<u>Gobo Folder selection</u>	
	21-240	Factory folders	step
	241-250	User folders	step
	251	Reserved	
	252	Live input (grab. card)-see channel 60	step
60	253-255	Streaming from remote source	step
		Reserved	
60	0	<u>Gobo selection</u>	step
	1 - 255	White	step
		255 Gobos/videos (one by one)	
		<i>If Live input (251 DMX) is selected on channel 59:</i>	
	0	White screen	step
	1-20	Video composite input-PAL system	step
	:	:	:

DigitalSpot 7000 DT

Fixture linkage:

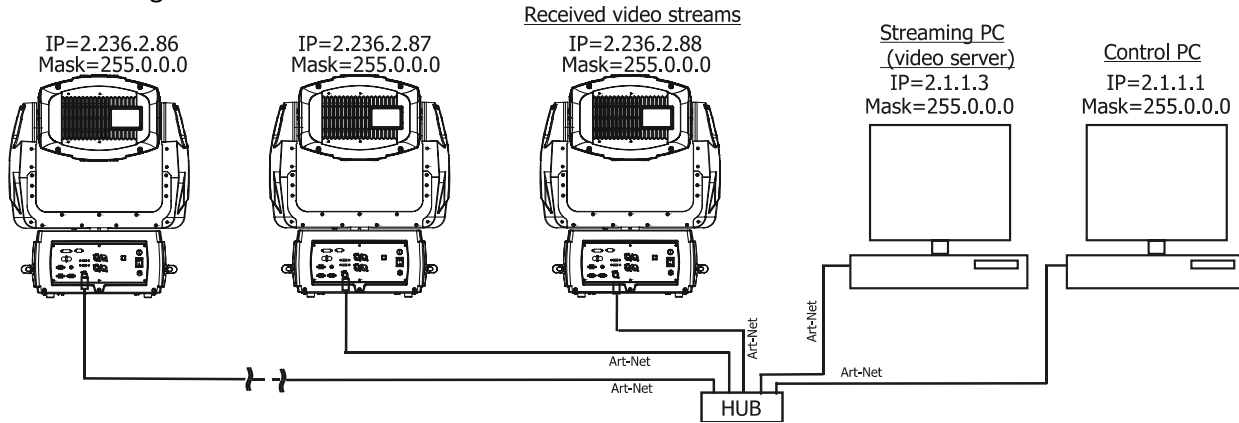

28. RDM

This fixture is ready for RDM operation. RDM (Remote Device Management) is a bi-directional communications protocol for use in DMX512 control systems, it is the new open standard for DMX512 device configuration and status monitoring.

The RDM protocol allows data packets to be inserted into a DMX512 data stream without adversely affecting existing non-RDM equipment. By using a special „Start Code,“ and by complying with the timing specifications for DMX512, the RDM protocol allows a console or dedicated RDM controller to send commands to and receive messages from specific moving lights.

RDM allows explicit commands to be sent to a device and responses to be received from it.

The ROBE DreamBox allows to utilize all DigitalSpot 7000 DT RDM functionality. Please read the DreamBox user manual for detail description of RDM possibilities.

29. Technical specifications

Electrical specifications

Auto-switching power supply

Input voltage range: 100-120V/ 200-240V AC, 50/60 Hz

Max. Power Consumption @ 230V: 780W (800VA), I=3.3A

Power factor: 0.96

Projector Specifications

Model:PLC-XP100L

Light output:6,500 ANSI lumens

Lamp:330 W NSHA

Rated lamp life: 3,000 h (eco mode); 2,000 h (normal mode)

Throw distance ratio: 1.8-2.4 : 1 (standard)

Contrast ratio:2000:1

LCD panel system:1.3" TFT Active Matrix type, 3 panels

Panel resolution:1,024 x 768 dots

Number of pixels: 2,359,296 (1,024 x 763 x 3 panels)

Hardware

Motherboard: MSI G31M-F

Processor: Intel Core2 Duo E6750, 2.66 GHz, 1333 MHz FSB

Memory: 1GB RAM

Graphics card: nVidia 9800 GT

Video capture card: AverMedia DVD EZMaker

Hard disk: Western Digital 500GB Caviar SE16 3.5"

Gigabit Ethernet

Operation system

Linux OS

Graphic engine

4 Digital Gobo Layers for Image and Video Control

Layer Media Control Modes (Copy, Add, Subtract, Multi, Minimum and Maximum)

Banner Effects creating action scripts for Images or Videos

Graphic engine supports a combined total of more than 60,000 original and user-created videos/gobos usable on all gobo layers

Digital Iris effect + 160 masking effects

Full Key-Stone correction

Digital strobe effect

CMY Image and Video Colour Mixing and CTC (Colour Temperature Correction)

2 independent effect channels on each gobo layer with more than one hundred of effects

Huge amount of Default Images/Videos

Import of User Images or Videos

Supported Image Formats: JPG, TGA, PNG, GIF, PCX, PNM, XPM and LBM (Max 4096x4096 pixel)

Supported Video Formats: MPEG1, MPEG2

Effect video synchronization

Preview of projecting output through web interface

Picture merging effect in the field up to 64 segments

Mirrored picture merging effect with unlimited numbers of pictures

Projection on to cylindrical/spherical surfaces and angular screens

Video processing on all gobo layers from a remote streaming video server

Electromechanical Effects

Zoom
Focus
Mechanical iris

Control

5" TFT LCD display & Robe navigation system
Web access for total control of fixture (user library management)
Media Content Synchronization in web interface
169 control channels max.
RDM support

Pan/Tilt

Pan movement range: 530°
Tilt movement range: 280°
16 bit movement resolution
Controllable speed of Pan/Tilt movement
Automatic Pan/Tilt position correction
Built-in Pan/Tilt macro effects

LedWash module

Light source: 2x 48 Luxeon Rebel LEDs (RGBW)
Optical system: 25° beam angle
RGB colour mixing
Shutter and adjustable strobe sequences
Full range dimming

Connections

video inputs: Data projector: 1 x S-Video (Mini Din 4 pin)
1 x VGA (Mini D-sub 15 pin)
Graphic Engine: standard:
1 x S-Video (Mini Din 4 pin)
1 x Composite video (RCA)
optional :
1 x DVI-D , 1 x VGA (Mini D-sub 15 pin)
1 x SDI/ASI (BNC)
DMX data in/out: Locking 3-pin and 5-pin XLRs
ArtNet: RJ 45 (Neutrik Ethercon)
AC power input: 1.3 m power cord without plug
2 x USB 2.0 (series A)

Environmental Specifications

Operating temperature range: 0° - 35°C
Maximum housing temperature: 60°C

Rigging

Mounting points: 4 pairs of ¼-turn locks
2 x Omega bracket with ¼-turn quick locks
Safety chain/cord attachment point

Accessories

Omega holder (No.99010420).....2 pieces
USB 2.0 flash drive with a System recovery utility.....1 piece

DigitalSpot 7000 DT

Optional Accessories

VGA/DVI capture card set (P.N. 99012388) – includes capture card DVI/VGA UFG-03A STD and mounting accessories

SDI/ASI capture card set (P.N. 99012445) – includes capture card SDI/ASI DTA-145-SDP and mounting accessories

Air filter for DS 7000 DT, PLC-XP100L (P.N. 17030507)

Long throw optics 2.7 – 3.5 : 1 (P.N. 10980056)

Short throw optics 1.2 – 1.7 : 1 (P.N. 10980057)

Dimensions (mm)

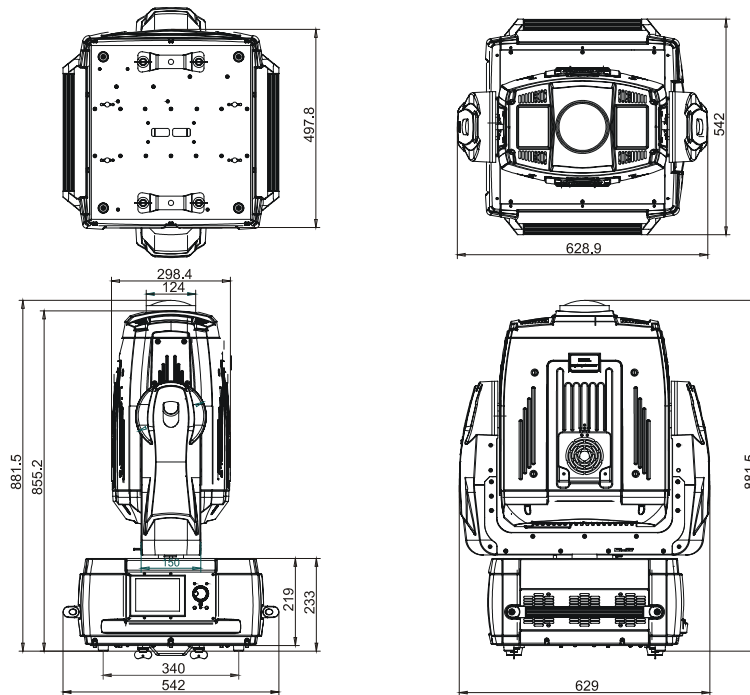

Weight

48 kg

DigitalSpot 7000 DT

Illuminance/Image size chart for Long Throw Optics (throw distance ratio 2.7 - 3.5 : 1)

Illuminance (white output)				Image Size	
Max. zoom	Min. zoom	Maximum	Minimum	Max. zoom	Min. zoom
132 lx 12 fc	212 lx 20 fc			X=6.7m (22') Y=5m (16.4')	X=5.1m (17') Y=3.9m (12.7')
167 lx 16 fc	268 lx 25 fc			X=5.9m (19.5') Y=4.4m (14.6')	X=4.6m (15') Y=3.4m (11.3')
190 lx 18 fc	305 lx 28 fc			X=5.6m (18.2') Y=4.17m (13.7')	X=4.3m (14.1') Y=3.2m (10.5')
254 lx 24 fc	406 lx 38 fc			X=4.8m (15.8') Y=3.6m (12')	X=3.7m (12.2') Y=2.8m (9.2')
354 lx 33 fc	568 lx 53 fc			X=4.1m (13.4') Y=3.1m (10')	X=3.1m (10.3') Y=2.4m (7.7')
529 lx 49 fc	848 lx 79 fc			X=3.3m (11') Y=2.5m (8.2')	X=2.6m (8.4') Y=2m (6.3')
670 lx 62 fc	1073 lx 100fc			X=3m (9.7') Y=2.2m (7.3')	X=2.3m (7.5') Y=1.7m (5.6')
875 lx 81 fc	1402 lx 130 fc			X=2.6m (8.5') Y=1.9m (6.4')	X=2m (6.6') Y=1.5m (4.9')
1190 lx 111 fc	1908 lx 172 fc			X=2.2m (7.3') Y=1.7m (5.5')	X=1.7m (5.6') Y=1.3m (4.2')
1714 lx 159 fc	2747 lx 255 fc			X=1.9m (6.1') Y=1.4m (4.6')	X=1.4m (4.7') Y=1.1m (3.5')
2678 lx 249 fc	4292 lx 399 fc			X=1.48m (4.9') Y=1.11m (3.6')	X=1.14m (3.7') Y=0.86m (2.8')
4761 lx 442 fc	7631 lx 709 fc			X=1.11m (3.6') Y=0.83m (2.7')	X=0.86m (2.8') Y=0.64m (2.1')
10713 lx 995 fc	17169 lx 1595 fc			X=0.74m (2.4') Y=0.56m (1.8')	X=0.57m (1.9') Y=0.43m (1.4')

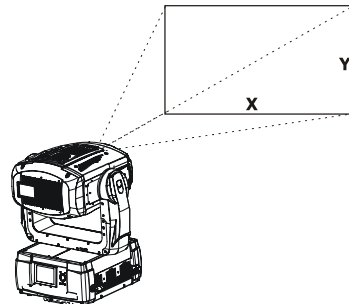
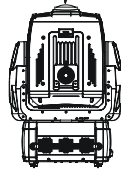

DigitalSpot 7000 DT

Illuminance/Image size chart for Short Throw Optics (throw distance ratio 1.2 - 1.7 : 1)

Illuminance (white output)		Image Size	
Max. zoom	Min. zoom	Max. zoom	Min. zoom
31 lx 3 fc	50 lx 5 fc	X=15m (49.2') Y=11.3m (40')	X=10.6m (34.7') Y=7.9m (26')
39 lx 3.6 fc	63 lx 6 fc	X=13.3m (43.7') Y=10m (32.8')	X=9.4m (31') Y=7m (23.1')
45 lx 4 fc	71 lx 7 fc	X=12.5m (41') Y=9.4m (31')	X=8.8m (28.9') Y=6.6m (21.7')
59 lx 6 fc	95 lx 9 fc	X=10.9m (35.5') Y=8.1m (26.7')	X=7.6m (25.1') Y=5.7m (18.8')
83 lx 8 fc	132 lx 12 fc	X=9.2m (30.1') Y=6.9m (22.6')	X=6.5m (21.2') Y=4.8m (15.9')
124 lx 12 fc	198 lx 18 fc	X=7.5m (24.6') Y=5.6m (18.5')	X=5.3m (17.4') Y=4m (13')
157 lx 15 fc	250 lx 23 fc	X=6.7m (22.1') Y=5m (16.4')	X=4.7m (15.5') Y=3.5m (11.5')
205 lx 19 fc	327 lx 30 fc	X=5.8m (19.1') Y=4.4m (14.4')	X=4.1m (13.5') Y=3.1m (10.1')
279 lx 26 fc	444 lx 41 fc	X=5m (16.4') Y=3.7m (12.3')	X=3.5m (11.6') Y=2.6m (8.7')
401 lx 37 fc	640 lx 60 fc	X=4.2m (13.7') Y=3.1m (10.3')	X=3m (9.6') Y=2.2m (7.3')
627 lx 58 fc	1000 lx 93 fc	X=3.33m (10.9') Y=2.5m (8.2')	X=2.35m (7.7') Y=1.76m (5.8')
1115 lx 104 fc	1778 lx 165 fc	X=2.5m (8.2') Y=1.88m (6.2')	X=1.76m (5.8') Y=1.32m (4.3')
2506 lx 233 fc	4000 lx 372 fc	X=1.67m (5.5') Y=1.25m (4.1')	X=1.18m (3.9') Y=0.88m (2.9')

Maximum Minimum

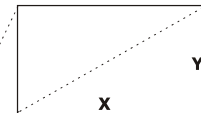
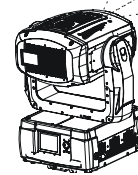
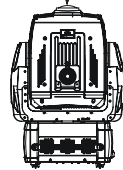

30. Error and information messages

The warning icon (triangle) on the bottom-right side of the fixture's screen indicates some error or information message which appears on the screen by pressing the [ESC] button.

Pan Error

The message will appear after the reset of the fixture if the yoke's magnetic-indexing circuit malfunctions (sensor failed or magnet is missing) or the stepping motor is defective or its driving IC3 on the PCB in the fixture base. The yoke is not located in the default position after the reset of the fixture.

Tilt Error

The message will appear after the reset of the fixture if the head's magnetic-indexing circuit malfunctions (sensor failed or magnet is missing) or the stepping motor is defective or its driving IC3 on the PCB in the fixture base. The head is not located in the default position after the reset of the fixture.

Focus Error

The message will appear after the reset of the fixture if the focus module's magnetic-indexing circuit malfunctions (sensor failed or magnet is missing) or the stepping motor is defective or its driving IC1 on the PCB in the fixture head. The focus is not located in the default position after the reset of the fixture.

Zoom Error

The message will appear after the reset of the fixture if the zoom's magnetic-indexing circuit malfunctions (sensor failed or magnet is missing) or the stepping motor is defective or its driving IC1 on the PCB in the fixture head. The zoom is not located in the default position after the reset of the fixture.

Power Down Mode

The fixture is in "power down mode"- this mode omits fixture reset after switching it on, and reduces the power of motors. "Power down mode" is useful in special cases e. g. if the fixture is in a flight case and you want to set its DMX address without taking it out from the case. To enter „Power down mode“, press and hold [ENTER] button and at the same time switch on the power switch.

Now you can set DMX address and behaviour of the fixture by using menu "Personality". If you want to go to a "normal operation mode", run a total fixture reset.

Please Clean Air Filters

The message warns you that the time interval adjusted in the menu item Time To Cleanup Filters in the Service menu has expired and you should clean fixture's air filters.

Please Update HW Processors in Menu "Special Functions"

Run update of the hardware functions - see chapter "Special functions".

LED Temperature Sensor Open

The message informs you that there is not communication between the sensor measuring the temperature of the LED module and the control PCB. This connection is broken.

LED Temperature Sensor Short

The message informs you that there is not communication between the sensor measuring the temperature of the LED module and the control PCB. This connection is in short circuit.

31. Maintenance

31.1 Replacing the lamp

Turn the power off and disconnect the fixture from the mains. If the lamp is hot, avoid burns by waiting for approximately 45 minutes until the lamp has cooled.

1. Use the tilt lock button (2) to secure the moving head in a horizontal position. If you look at the rear cover of the head, the warning writings has to be in a readable position

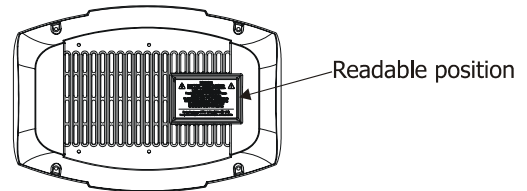

2. Remove the rear plastic cover (1) of the head by loosening the four quarter-turn fasteners (2).

3 Loosen the three quarter-turn fasteners (3) at the rear part of the projector chassis.

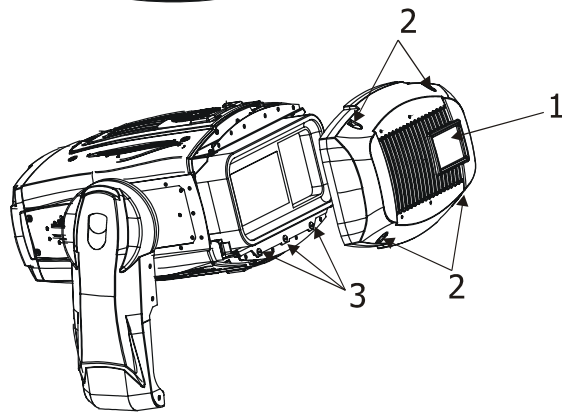

4. Carefully take the projector (4) with the chassis (5) out from the head. The lamp cover (6) is placed next to the filter compartment.

5 Loosen the screw and open the lamp cover. Pull out the lamp by using the built in handle. Do not turn the power on with the lamp cover removed.

6 Replace the lamp with a new one. Make sure that the lamp is properly and fully inserted.

7 Close the lamp cover and secure the screw.

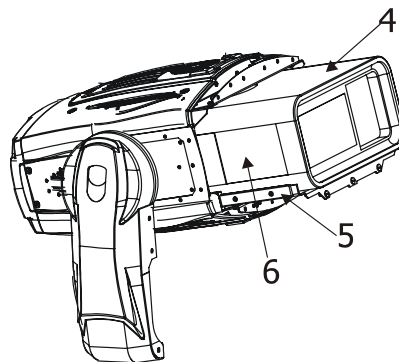

8. Insert the projector with chassis back to the head and secure the three quarter-turn fasteners (3).

31.2 Replacing the projector

If you need to remove the data projector, turn the power off and disconnect the DigitalSpot 7000 DT from the mains. If the projector lamp is on, wait 25 minutes until the projector has cooled.

1. Use the tilt lock button to secure the moving head in a horizontal position. If you look at the rear cover of the head, the warning writings has to be in a readable position.

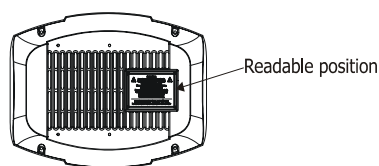

2. Remove top/bottom and front/rear plastic covers of the head by loosening the four quarter-turn fasteners (1) on each cover.

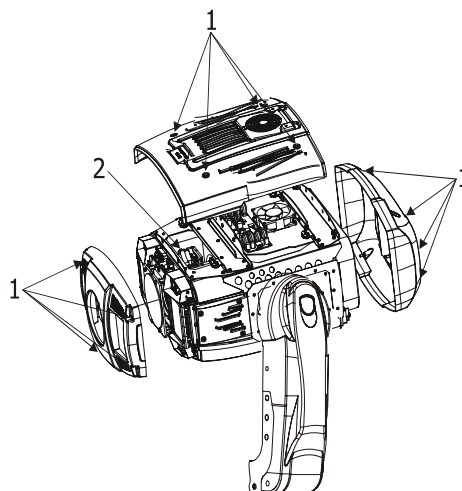

3. Disconnect cables (2) from motors and sensors (3 motor cables and 2 sensor cables) in the front part of the fixture head.

4. Disconnect power and data cables (3) from the rear panel of the projector (4). Cut the cable fixing eyes at the side of the projector chassis.

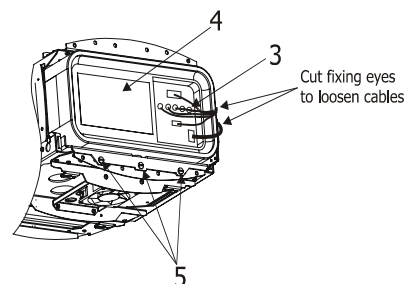

5. Unscrew the two Allen screws (5) at the bottom part of the projector chassis (7).

6. Loosen the three quarter-turn fasteners (5) at the rear part of the projector chassis.

Warning:

The projector can fall out from the head when these fasteners are loosen.

7. Carefully take the projector (4) with the chassis (7) out from the head. If the projector chassis is ejected in 2/3 of its way, you have to release the securing latches (8) placed on both sides of the chassis (by pressing one latch down and lifting next one on the opposite side).

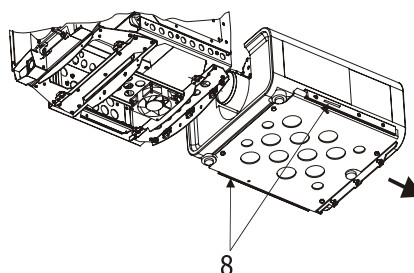
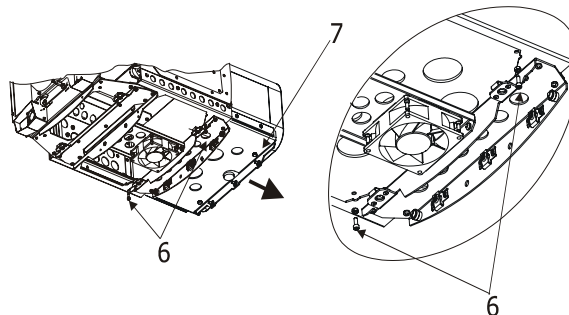

31.3 Accessing to the projector control buttons

If you need to use the projector control buttons which are situated at the side of the projector, move the fixture head to the horizontal position as figured on the picture below (if you look at the rear cover of the head, the warning writings has to be in a readable position), and remove the side plastic cover by loosening the 4 screws.

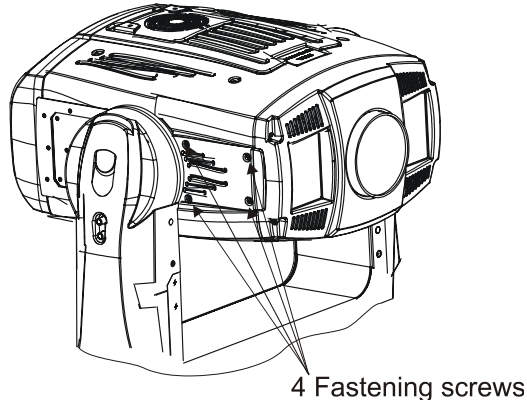

31.4 Installing the DVI/VGA capture card

To install the optional DVI/VGA capture card.

1. Disconnect the fixture from power.
2. Remove both top covers (1) of the fixture base by unscrewing 14 screws (2).
3. Remove the cover plate (3) of an unused slots for DVI/VGA connectors on the rear panel of the fixture by unscrewing 4 screws (4).
4. Screw the connecting block (5) with DVI/VGA connectors to the rear panel by means of the 4 hexagonal pillars which have a threaded stud.
5. Remove the capture card (6) from its packaging and gently press it down into the empty PCI slot. Secure the bracket of the card to the chassis by means of the screw (7) with M3 thread.
6. Connect a VGA and DVI cable to the capture card.
7. Place both top covers of the fixture base back and fasten them by 14 screws.
8. After switching the fixture on, the capture card should be ready for operation (to activate its DVI or VGA input, set DMX value on the **Gobo selection** channel at desired gobo layer).

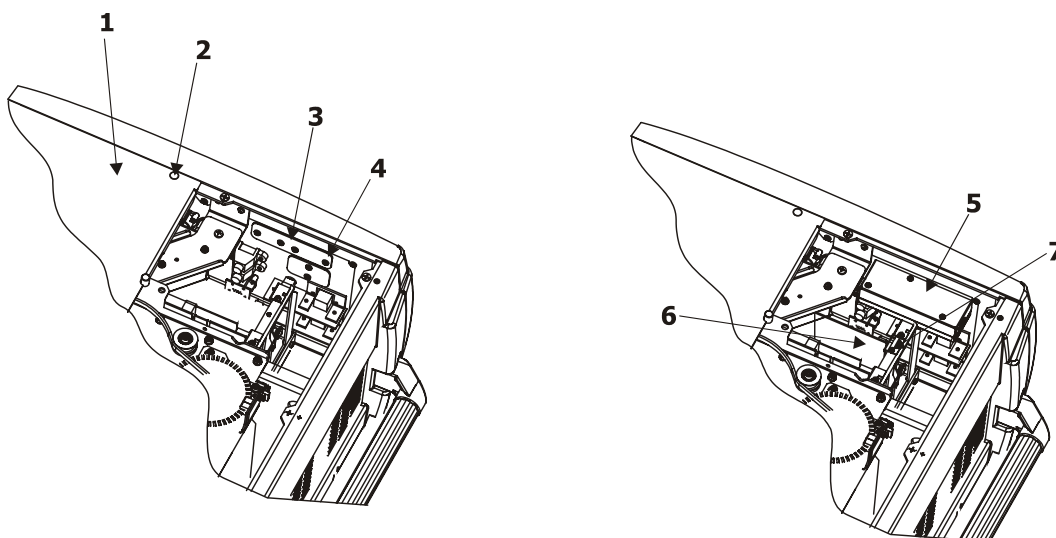

31.5 Installing the SDI/ASI capture card

To install the optional SDI/ASI capture card.

1. Disconnect the fixture from power.
2. Remove both top covers (1) of the fixture base by unscrewing 14 screws (2).
3. Remove the cover plate (6) of an unused slots for SDI/ASI connectors on the rear panel of the fixture by unscrewing the 2 screws (5) M3x6.
4. Unscrew six fastening screws (4) and carefully tilt the rear panel from the chassis.

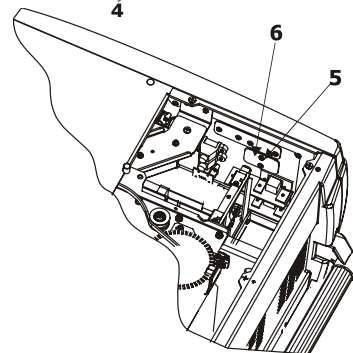
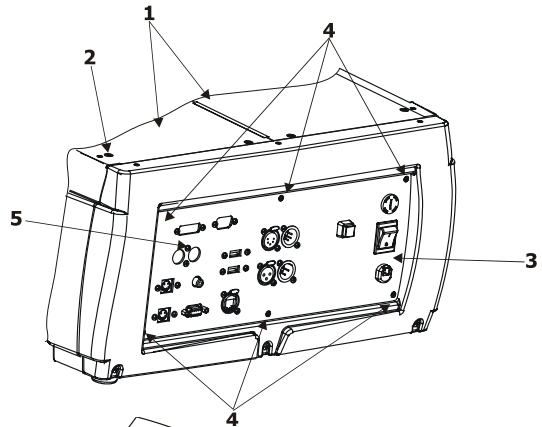

5. Remove the cover (7) of the SDI/ASI connectors holder (8) by unscrewing the two screws M3x6 (9).

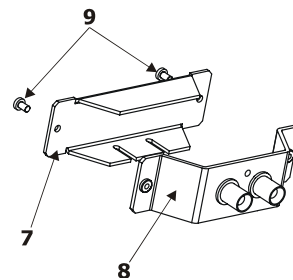

6. Snap the two insulating washers with outer diameter of 10mm (10) into SDI/ASI connectors holder (8) and fasten this holder on the rear panel (3) with two screws M3x10 (9). The SDI/ASI cables (11) have to aim at the bottom of the fixture base.

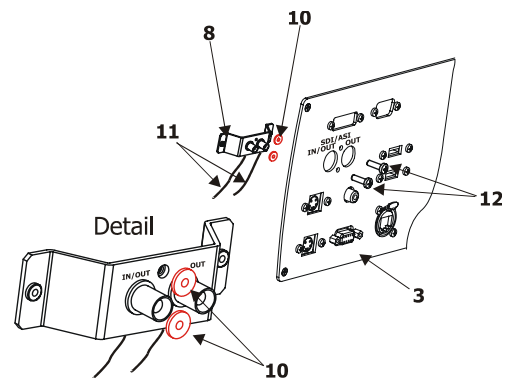

Keep right order of the insulating (13) and metal (14) washers on the screws (9) and tighten the nuts (15).

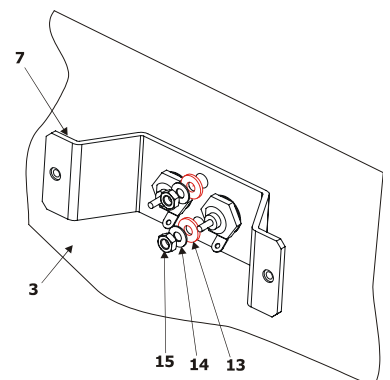

Warning: The SDI/ASI connectors holder has to be electrically insulated from the rear panel otherwise the capture card can be damaged.

Check right placing of the insulating washers.

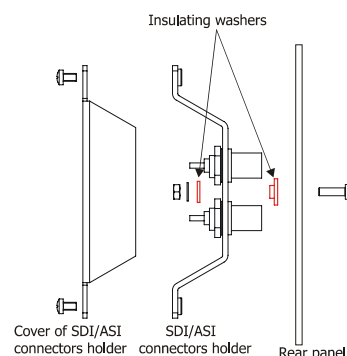

7. Screw the cover (7) to the SDI/ASI connectors holder (8) with two screws M3x6 (9). Screw the rear panel (3) back to the chassis.

8. Remove the capture card from its packaging and gently press it down into the empty PCI slot. Secure the bracket of the card to the chassis by means of the screw (16) with M3 thread.

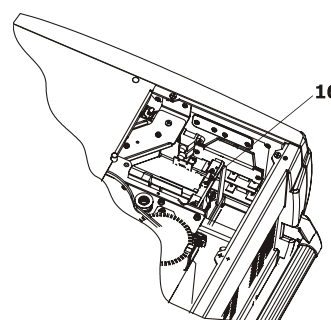

9. Connect the SDI/ASI cables to the capture card. The IN/OUT cable has a blue sleeve at BNC connector and the OUT cable has a red one.

BNC sockets on the capture card are marked $\text{---} \odot \rightarrow$ (OUT) and $\text{---} \odot \leftarrow$ (IN/OUT).

10. Place both top covers of the fixture base back and fasten them by 14 screws.

11. After switching the fixture on, the capture card should be ready for operation.

To activate its SDI or ASI input, set DMX value on the **Gobo selection** channel at desired gobo layer.

31.6 Installing the optional optics

To install the long throw optics (or short throw optics) follow the steps:

1. Disconnect the DigitalSpot 7000 DT from power.

2. Remove the front cover of the fixture head (2) by loosening the 4 quarter-turn fasteners (1).

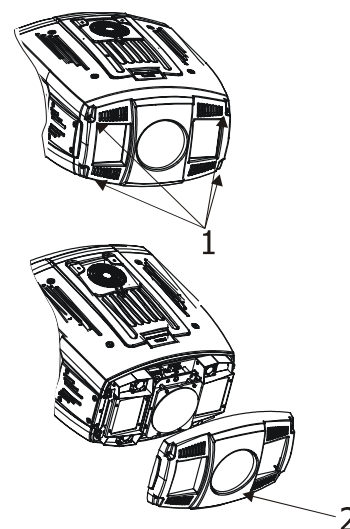

3. Remove the module of the glass cover (4) by loosening the three quarter-turn fasteners (3).

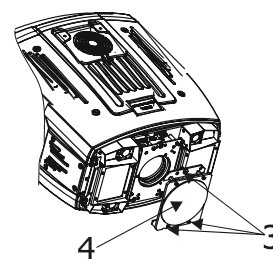

4. Place the long (short) throw optic module (5) instead of the module of the glass cover (4) and secure it by the 3 quarter-turn fasteners (6).

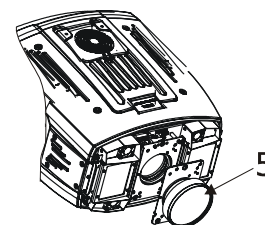

5. Fasten the plastic front cover back on the fixture head by means of the 4 quarter-turn fasteners.

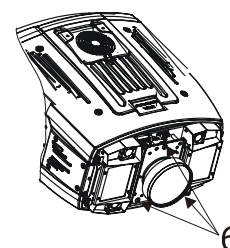

6. Select the option **Long Throw Optics** (for the long throw optics with throw distance ration 2.7-3.5: 1) or **Short Throw Optics** (for the short throw optics with throw distance ration 1.2-1.7:1) in the menu "Personality" ("Personality" → "Projection presetting" → "Throw Optics Mode).

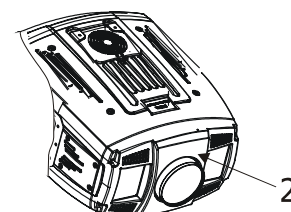

31.7 Replacing the fixture air filters

Important! Check the air filters periodically and clean before they become clogged!

Clean the air filters with a vacuum cleaner or you can wash them and put back dry.

Replacing air filters in the fixture head.

1. Disconnect the fixture from power.
2. Raise up the filter cover (fixed by two magnets) on the head cover.
3. Pull the air filter out.
4. Clean or replace the air filter.
5. Snap the filter cover back to the head cover.
6. Reset item "Time To Cleanup Filters" in the "Service menu"

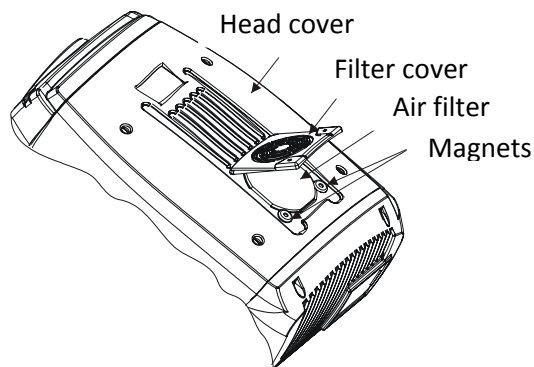

Replacing the air filter in the fixture base.

1. Disconnect the fixture from power.
2. Remove the side cover by loosening the 4 quarter-turn fasteners.
3. Pull the air filter out.
4. Clean or replace the air filter .
5. Put the side cover back.
6. Reset item "Time To Cleanup Filters" in the "Service menu".

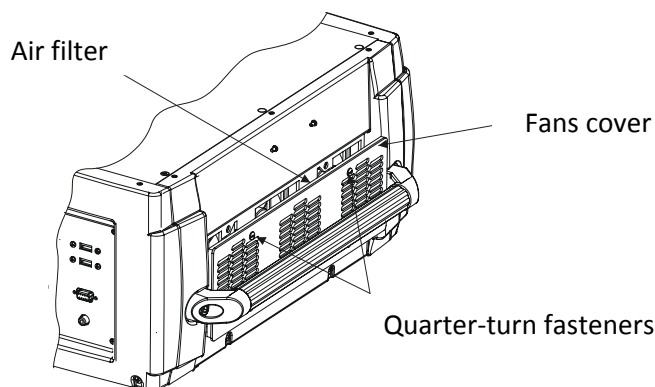

We recommend avoiding dusty/smoky environments when operating the fixture. Usage in these environments may cause a poor image quality. When using the fixture under dusty or smoky conditions, dust may accumulate on a lens, liquid crystal panels, or optical elements inside the projector. Such condition may degrade the quality of the projected image.

31.8 Replacing the filter cartridge in the projector.

1. Turn off the DigitalSpot 7000 DT and unplug the AC power cord from the AC outlet.
2. Remove the projector from the fixture chassis as described in the chapter **Replacing the projector**.
3. Press ▲ on the filter cover to release the latch and open the filter cover.
4. Pull out the filter cartridge. When taking out the filter cartridge, put your finger on the filter cartridge's tab and then pull.
5. Put the new one back into the position and close the filter cover. Make sure that the filter cartridge is properly and fully inserted. Make sure the filter cartridge is inserted in the projector. If the filter cartridge is not inserted, the projector cannot be turned on. Do not put anything into the air vents. Doing so may result in malfunction of the projector.
6. Turn the projector on and reset the filter counter and the scroll counter as described below.
7. Place the projector back to the fixture chassis.

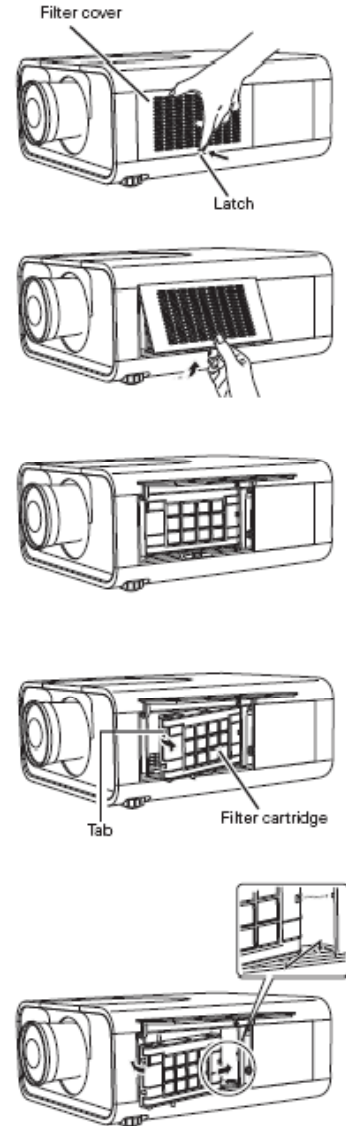

31.8.1 Reseting the Filter Counter

1. Press the MENU button on the projector to display the On-Screen Menu. Use the Point ◀▶ buttons to move the red frame pointer to the Setting Menu icon.

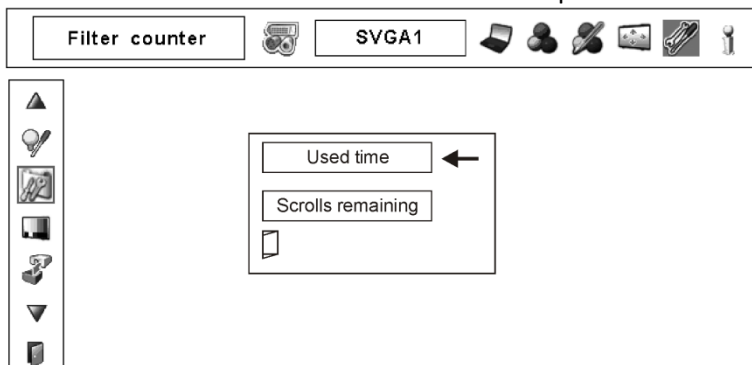

- Use the Point ▲▼ buttons to move the red frame pointer to Filter counter and then press the SELECT button. A dialog box appears showing the Used time option and the Scrolls remaining option. Use the Point ▲▼ buttons to select Used time.

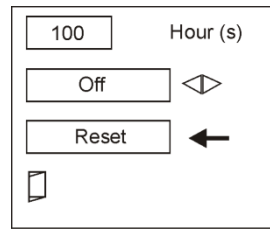

- Used time shows the total accumulated time of the filter use, a timer setting option, and the Reset option. Select Reset and the “Filter counter Reset?” appears. Select [Yes] to continue.

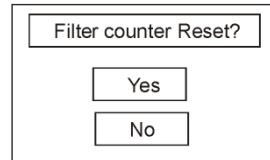

- Another confirmation dialog box appears, select [Yes] to reset the Filter counter.

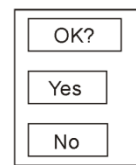

31.8.2 Ressetting the Scroll Counter

- Press the MENU button on the projector to display the On-Screen Menu. Use the Point ◀▶ buttons to move the red frame pointer to the Setting Menu icon.

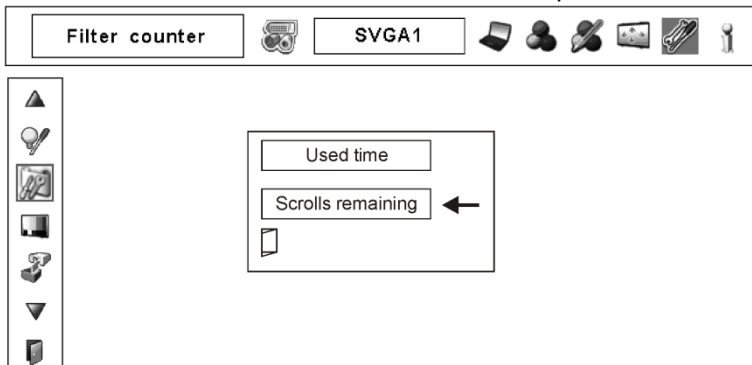

- Use the Point ▲▼ buttons to move the red frame pointer to Filter counter and then press the SELECT button. A dialog box appears showing the Used time option and the Scrolls remaining option. Use the Point ▲▼ buttons to select Scroll(s) remaining.

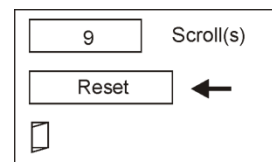

- Scroll(s) remaining shows the number of the remaining scrolls and the Reset option. Select Reset and the “Scroll counter Reset?” appears. Select [Yes] to continue.

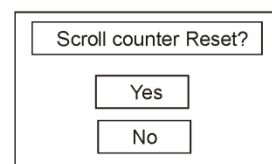

- Another confirmation dialog box appears, select [Yes] to reset the Scroll counter.

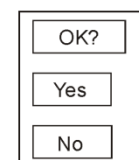

31.9 Replacing the fuse

Only replace the fuse by a fuse of same type and rating.

Before replacing the fuse, turn the power off and unplug the mains lead.

Procedure:

- 1) Unscrew the fuse holder on the rear panel of the base with a fitting screwdriver from the housing (anti - clockwise).
- 2) Remove the old fuse from the fuse holder.
- 3) Install the new fuse in the fuse holder.
- 4) Replace the fuse holder in the housing and fix it.

31.10 System restore

You can perform a system restore on the DigitalSpot 7000 DT with your System Restore USB flash drive.

Warning.
***The system restore replaces all fixture settings and the Media folder content.
This action return the device to a factory state.***

For a system restore, you will need:

- the USB flash drive with a System restore utility (part of Digital 7000 DT delivery)
- the USB keyboard

Use the following steps to perform a system restore:

1. Plug the USB flash drive with System restore utility and the USB keyboard into two external USB ports on the DigitalSpot 7000 DT.
2. Power on the DigitalSpot 7000 DT. When the fixture boots, press Delete key on the keyboard to enter the fixture's computer SETUP and set the boot from USB drive (Path: "Advanced Bios Features" --- >"1st boot device"----> "[USB]).
3. Save this setting and exit SETUP. The fixture continues booting, wait until you see a full-screen menu titled:

Image Manager for ROBE Digital Products

Options:

Write "rescue" for enter to Main Menu

4. Type the word **rescue** on the keyboard and the following screen will appear:

Options:

Restore From Backup

Restart

5. Select option "Restore From Backup" to start recovery process This process will take cca 5 minutes.
6. Select option "Restart" to restart the fixture. After a few minutes you may remove all your external USB devices. Now the fixture is in a factory state and you should perform update (if required) of graphical software, HW processors and media content to the current state.

31.11 Cleaning

Turn the power off and disconnect the fixture from the mains before starting cleaning procedure.

It is absolutely essential that the fixture is kept clean and that dust, dirt and smoke-fluid residues must not build up on or within the fixture. Otherwise, the fixture's light-output will be significantly reduced. Regular cleaning will not only ensure the maximum light-output, but will also allow the fixture to function reliably throughout its life.

A soft lint-free cloth moistened with any good glass cleaning fluid is recommended, under no circumstances should alcohol or solvents be used!

DANGER !
***Disconnect from the mains before starting any
cleaning and maintenance work***

The front covering glasses will require weekly cleaning as smoke-fluid tends to building up residues, reducing the light output very quickly.

The cooling fans should be cleaned monthly.

The interior of the fixture should be cleaned at least annually using a vacuum-cleaner or an air-jet.

More complicated maintenance and service operations are only to be carried out by authorized dealers.

Cleaning a projection lens of the projector.

Apply a non-abrasive camera lens cleaner to a soft, dry cleaning cloth. Avoid using an excessive amount of cleaner. Abrasive cleaners, solvents or other harsh chemicals might scratch a surface. Lightly wipe a cleaning cloth over projection lens.

DigitalSpot 7000 DT - DMX protocol v. 1.4, June 25, 2009			
DMX Channel	DMX Value	Function	Type of control
1		Pan	
	0-255	Pan movement by 530°	proportional
2		Pan Fine	
	0-255	Fine control of pan movement	proportional
3		Tilt	
	0-255	Tilt movement by 280°	proportional
4		Tilt Fine	
	0-255	Fine control of tilt movement	proportional
5		Pan/Tilt speed,Pan/Tilt time	
	0	Max.speed (tracking mode)	step
		<i>P./T. speed-set Speed Mode in menu: Pan/Tilt Mode</i>	
	1-255	Speed from max. to min.(vector mode)	step
		<i>P./T. time-set Time Mode in menu: Pan/Tilt Mode</i>	
	1-255	Time from 0.1s to 25.5s	step
6		Pan/Tilt macro selection	
	0-9	Disabled pan/tilt macro	step
	10-31	Reserved	
	32-63	Figure of circle (from small to large)	proportional
	64-95	Figure of horizontal eight (from small to large)	proportional
	96-127	Figure of vertical eight (from small to large)	proportional
	128-159	Figure of reactangle (from small to large)	proportional
	160-191	Figure of triangle (from small to large)	proportional
	192-223	Figure of star (from small to large)	proportional
	224-255	Figure of cross (from small to large)	proportional
7		Pan/Tilt macro speed	
	0	No macro	step
	1-127	Macro generation from fast to slow (forwards)	proportional
	128-129	No macro	step
	130-255	Macro generation from slow to fast (backwards)	proportional
8		Power/Special functions	
	0-39	Reserved	
		To activate following function, the LED Shutter (channel 21) must be at range 240-250 DMX.	
	40-44	Internal Hardware (PC) reset	step
	45-49	Reserved	
		To activate following functions,hold DMX value 3 sec. and digital iris must be closed at least 3 sec. (channel 38 must be at 255 DMX).Corresponding menu items are temporarily overridden	
	50-59	Pan/Tilt speed mode	step
	60-69	Pan/Tilt time mode	step
	70-79	Blackout while pan/tilt moving	step
	80-89	Disabled blackout while pan/tilt moving	step
	90-94	Ceiling projection On	step
	95-99	Ceiling projection Off	step
	100-104	Rear projection On	step
	105-109	Rear projection Off	step
	110-114	DMX In	step
	115-119	Artnet In	step
	120-129	Reserved	

DMX protocol

DMX Channel	DMX Value	Function	Type of control
8		To activate following functions,hold DMX value 3 seconds	
	130-139	Lamp On	step
	140-149	Pan/Tilt reset	step
	150-179	Reserved	
	180-189	Zoom/Focus reset	step
	190-199	Mechanical iris reset	step
	200-209	Total reset	step
	210-215	Graphic engine reset/software update executing	step
	216-229	Reserved	
	230-239	Lamp Off	step
	240-249	Lamp Off,Fixture Off (<i>hold DMX value 5 seconds</i>)	step
	250-255	Reserved	
9		Video input selection	
	0-63	Internal graphic engine	step
	64-127	External VGA to projector	step
	128-191	External S-video to projector	step
	192-255	Reserved	
10		Zoom	
	0-255	Zoom from min. to max. (128-default)	proportional
11		Focus	
	0-255	Continuous adjustment from far to near (128-default)	proportional
12		Mechanical iris	
	0	Open	step
	1-255	Fom max. diameter to min. diameter	proportional
13		Red LEDs 1	
	0-255	Red LEDs saturation control 0 --> 100 %	proportional
14		Green LEDs 1	
	0-255	Green LEDs saturation control 0 --> 100 %	proportional
15		Blue LEDs 1	
	0-255	Blue LEDs saturation control 0 --> 100 %	proportional
16		White LEDs 1	
	0-255	White LEDs saturation control 0 --> 100 %	proportional
17		Red LEDs 2	
	0-255	Red LEDs saturation control 0 --> 100 %	proportional
18		Green LEDs 2	
	0-255	Green LEDs saturation control 0 --> 100 %	proportional
19		Blue LEDs 2	
	0-255	Blue LEDs saturation control 0 --> 100 %	proportional
20		White LEDs 2	
	0-255	White LEDs saturation control 0 --> 100 %	proportional
21		LED shutter and strobe	
	0-31	Shutter closed	step
	32-63	Shutter open	step
	64-95	Strobe effect, slow --> fast	proportional
	96-127	Shutter open	step
	128-143	Opening pulses in sequences, slow --> fast	proportional
	144-159	Closing pulses in sequences, fast --> slow	proportional
	160-191	Shutter open	step
	192-223	Random strobe-effects, slow --> fast	proportional

DMX protocol

DMX Channel	DMX Value	Function	Type of control
	224-255	Shutter open	step
22		LED Dimmer	
	0-255	Led module dimmer intensity 0 --> 100 %	proportional
Common digital effects for all gobo layers			
23		KeyStone Top Left X	
	0-255	Move top left corner X value to center (0-default)	proportional
24		KeyStone Top Left Y	
	0-255	Move top left corner Y value to center (0-default)	proportional
25		KeyStone Top Right X	
	0-255	Move top right corner X value to center (0-default)	proportional
26		KeyStone Top Right Y	
	0-255	Move top right corner Y value to center (0-default)	proportional
27		KeyStoneBottom Right X	
	0-255	Move bottom right corner X value to center (0-default)	proportional
28		KeyStone Bottom Right Y	
	0-255	Move bottom right corner Y value to center (0-default)	proportional
29		KeyStone Bottom Left X	
	0-255	Move bottom left corner X value to center (0-default)	proportional
30		KeyStone Bottom Left Y	
	0-255	Move bottom left corner Y value to center (0-default)	proportional
31		KeyStone X-ratio	
	0-127	Ratio control from left to center	proportional
	128	Center (default)	step
	129-255	Ratio control from center to right	proportional
32		KeyStone Y-ratio	
	0-127	Ratio control from bottom to center	proportional
	128	Center (default)	step
	129-255	Ratio control from center to top	proportional
33		Cyan	
	0-255	Cyan continuously (0-white,255-full cyan)	proportional
34		Magenta	
	0-255	Magenta continuously (0-white,255-full magenta)	proportional
35		Yellow	
	0-255	Yellow continuously (0-white,255-full yellow)	proportional
36		CTF	
	0	Without CTF	step
	1	14000 K	step
	2	13000 K	step
	3	12500 K	step
	4	12000 K	step
	5	11500 K	step
	6	11000 K	step
	7	10500 K	step
	8	10000 K	step
	9	9500 K	step
	10	9000 K	step
	11	8600 K	step
	12	8575 K	step
	13	8550 K	step

DMX protocol

DMX Channel	DMX Value	Function	Type of control
	:	:	:
	255	2500 K	step
37		Digital Iris-type selection	
	0	Circular ,outside-->in,sharp edge	step
	1	Circular ,outside-->in,fuzzy edge 1	step
	2	Circular ,outside-->in,fuzzy edge 2	step
	3	Circular ,outside-->in,fuzzy edge 3	step
	4	Circular ,outside-->in,fuzzy edge 4 (maximum)	step
	5	Circular ,inside-->out,sharp edge	step
	6	Circular ,inside-->out,fuzzy edge 1	step
	7	Circular ,inside-->out,fuzzy edge 2	step
	8	Circular ,inside-->out,fuzzy edge 3	step
	9	Circular ,inside-->out,fuzzy edge 4 (maximum)	step
	10	Horizontal ellipse ,outside-->in,sharp edge	step
	11	Horizontal ellipse ,outside-->in,fuzzy edge 1	step
	12	Horizontal ellipse ,outside-->in,fuzzy edge 2	step
	13	Horizontal ellipse ,outside-->in,fuzzy edge 3	step
	14	Horizontal ellipse ,outside-->in,fuzzy edge 4 (maximum)	step
	15	Horizontal ellipse ,inside-->out,sharp edge	step
	16	Horizontal ellipse ,inside-->out,fuzzy edge 1	step
	17	Horizontal ellipse ,inside-->out,fuzzy edge 2	step
	18	Horizontal ellipse ,inside-->out,fuzzy edge 3	step
	19	Horizontal ellipse ,inside-->out,fuzzy edge 4 (maximum)	step
	20	Vertical ellipse ,outside-->in,sharp edge	step
	21	Vertical ellipse ,outside-->in,fuzzy edge 1	step
	22	Vertical ellipse ,outside-->in,fuzzy edge 2	step
	23	Vertical ellipse ,outside-->in,fuzzy edge 3	step
	24	Vertical ellipse ,outside-->in,fuzzy edge 4 (maximum)	step
	25	Vertical ellipse ,inside-->out,sharp edge	step
	26	Vertical ellipse ,inside-->out,fuzzy edge 1	step
	27	Vertical ellipse ,inside-->out,fuzzy edge 2	step
	27	Vertical ellipse ,inside-->out,fuzzy edge 3	step
	29	Vertical ellipse ,inside-->out,fuzzy edge 4 (maximum)	step
	30	Clockwise wipe,sharp edge	step
	31	Clockwise wipe,fuzzy edge 1	step
	32	Clockwise wipe,fuzzy edge 2	step
	33	Clockwise wipe,fuzzy edge 3	step
	34	Clockwise wipe,fuzzy edge 4 (maximum)	step
	35	Anticlockwise wipe,sharp edge	step
	36	Anticlockwise wipe,fuzzy edge 1	step
	37	Anticlockwise wipe,fuzzy edge 2	step
	38	Anticlockwise wipe,fuzzy edge 3	step
	39	Anticlockwise wipe,fuzzy edge 4 (maximum)	step
	40	Wedge wipe ,top-->down, sharp edge	step
	41	Wedge wipe ,top-->down, fuzzy edge 1	step
	42	Wedge wipe ,top-->down, fuzzy edge 2	step
	43	Wedge wipe ,top-->down, fuzzy edge 3	step
	44	Wedge wipe ,top-->down, fuzzy edge 4 (maximum)	step
45	Wedge wipe ,bottom-->up, sharp edge	step	
46	Wedge wipe ,bottom-->up, fuzzy edge 1	step	

DMX protocol

DMX Channel	DMX Value	Function	Type of control
37	47	Wedge wipe ,bottom-->up, fuzzy edge 2	step
	48	Wedge wipe,bottom-->up, fuzzy edge 3	step
	49	Wedge wipe,bottom-->up, fuzzy edge 4 (maximum)	step
	50	Radial wipe ,left -->bottom,sharp edge	step
	51	Radial wipe ,left -->bottom,fuzzy edge 1	step
	52	Radial wipe ,left -->bottom,fuzzy edge 2	step
	53	Radial wipe ,left -->bottom,fuzzy edge 3	step
	54	Radial wipe ,left -->bottom,fuzzy edge 4 (maximum)	step
	55	Radial wipe ,bottom-->left,sharp edge	step
	56	Radial wipe ,bottom-->left,fuzzy edge 1	step
	57	Radial wipe ,bottom-->left,fuzzy edge 2	step
	58	Radial wipe ,bottom-->left,fuzzy edge 3	step
	59	Radial wipe ,bottom-->left,fuzzy edge 4 (maximum)	step
	60	Radial wipe ,top-->left,sharp edge	step
	61	Radial wipe ,top-->left,fuzzy edge 1	step
	62	Radial wipe ,top-->left,fuzzy edge 2	step
	63	Radial wipe ,top-->left,fuzzy edge 3	step
	64	Radial wipe ,top-->left,fuzzy edge 4 (maximum)	step
	65	Radial wipe ,left-->top,sharp edge	step
	66	Radial wipe ,left-->top,fuzzy edge 1	step
	67	Radial wipe ,left-->top,fuzzy edge 2	step
	68	Radial wipe ,left-->top,fuzzy edge 3	step
	69	Radial wipe ,left-->top,fuzzy edge 4 (maximum)	step
	70	Vertical barn-doors,outside-->in,sharp edge	step
	71	Vertical barn-doors,outside-->in,fuzzy edge 1	step
	72	Vertical barn-doors,outside-->in,fuzzy edge 2	step
	73	Vertical barn-doors,outside-->in,fuzzy edge 3	step
	74	Vertical barn-doors,outside-->in,fuzzy edge 4 (maximum)	step
	75	Vertical barn-doors,inside-->out,sharp edge	step
	76	Vertical barn-doors,inside-->out,fuzzy edge 1	step
77	Vertical barn-doors,inside-->out,fuzzy edge 2	step	
78	Vertical barn-doors,inside-->out,fuzzy edge 3	step	
79	Vertical barn-doors,inside-->out,fuzzy edge 4 (maximum)	step	
80	Horizontal barn-doors,outside-->in,sharp edge	step	
81	Horizontal barn-doors,outside-->in,fuzzy edge 1	step	
82	Horizontal barn-doors,outside-->in,fuzzy edge 2	step	
83	Horizontal barn-doors,outside-->in,fuzzy edge 3	step	
84	Horizontal barn-doors,outside-->in,fuzzy edge 4 (maximum)	step	
85	Horizontal barn-doors,inside-->out,sharp edge	step	
86	Horizontal barn-doors,inside-->out,fuzzy edge 1	step	
87	Horizontal barn-doors,inside-->out,fuzzy edge 2	step	
88	Horizontal barn-doors,inside-->out,fuzzy edge 3	step	
89	Horizontal barn-doors,inside-->out,fuzzy edge 4 (maximum)	step	
90	Horizontal one-way band wipe,top left-->bottom right	step	
91	Horizontal one-way band wipe,bottom right-->top left	step	
92	Horizontal one-way band wipe,top right-->bottom left	step	
93	Horizontal one-way band wipe,bottom left-->top right	step	
94	Horizontal two-way band wipe,top left-->bottom right	step	
95	Horizontal two-way band wipe,bottom right-->top left	step	
96	Horizontal two-way band wipe,top right-->bottom left	step	

DMX protocol

DMX Channel	DMX Value	Function	Type of control
37	97	Horizontal two-way band wipe,bottom left-->top right	step
	98	Vertical one-way band wipe,top left-->bottom right	step
	99	Vertical one-way band wipe,bottom right-->top left	step
	100	Vertical one-way band wipe,bottom left-->top right	step
	101	Vertical one-way band wipe,top right-->bottom left	step
	102	Vertical two-way band wipe,top right-->bottom left	step
	103	Vertical two-way band wipe,bottom right-->top left	step
	104	Vertical two-way band wipe,bottom left-->top right	step
	105	Vertical two-way band wipe,top right-->bottom left	step
	106	Horizontal bands 4x,top-->bottom	step
	107	Horizontal bands 4x,bottom-->top	step
	108	Vertical bands 4x,left -->right	step
	109	Vertical bands 4x,right -->left	step
	110	Horizontal bands 8x,top-->bottom	step
	111	Horizontal bands 8x,bottom-->top	step
	112	Vertical bands 8x,left-->right	step
	113	Vertical bands 8x,right-->left	step
	114	Horizontal bands 16x,top-->bottom	step
	115	Horizontal bands 16x,bottom-->top	step
	116	Vertical bands 16x,left-->right	step
	117	Vertical bands 16x,right-->left	step
	118	Horizontal bands 32x,top-->bottom	step
	119	Horizontal bands 32x,bottom-->top	step
	120	Vertical bands 32x,left-->right	step
	121	Vertical bands 32x,right-->left	step
	122	Horizontal crossing 4x	step
	123	Horizontal crossing 4x,inverse	step
	124	Vertical crossing 4x	step
	125	Vertical crossing 4x,inverse	step
	126	Horizontal crossing 8x	step
	127	Horizontal crossing 8x,inverse	step
	128	Vertical crossing 8x	step
	129	Vertical crossing 8x,inverse	step
	130	Horizontal crossing 16x	step
	131	Horizontal crossing 16x,inverse	step
	132	Vertical crossing 16x	step
	133	Vertical crossing 16x,inverse	step
134	Checker wipe 3x4, left-->right	step	
135	Checker wipe 3x4, right-->left	step	
136	Checker wipe 4x4, left-->right	step	
137	Checker wipe 4x4, right-->left	step	
138	Checker wipe 5x8, left-->right	step	
139	Checker wipe 5x8, right-->left	step	
140	Checker wipe 9x8, left-->right	step	
141	Checker wipe 9x8, right-->left	step	
142	Checker wipe 9x16, left-->right	step	
143	Checker wipe 9x16, right-->left	step	
144	Checker wipe 10x32, left-->right	step	
145	Checker wipe 10x32, right-->left	step	
146	2 diagonal curtains, bottom left-->center<-- top right	step	

DMX protocol

DMX Channel	DMX Value	Function	Type of control
37	147	2 diagonal curtains, top left-->center<-- bottom right	step
	148	Grid wipe 8x8,bottom right-->top left	step
	149	Grid wipe 8x8,bottom right-->top left,inverse	step
	150	Grid wipe 8x8,top right-->bottom left	step
	151	Grid wipe 8x8,top right-->bottom left,inverse	step
	152	Grid wipe 16x16,bottom right-->top left	step
	153	Grid wipe 16x16,bottom right-->top left,inverse	step
	154	Grid wipe 16x16,top right-->bottom left	step
	155	Grid wipe 16x16,top right-->bottom left,inverse	step
	156	Grid wipe 32x32,bottom right-->top left	step
	157	Grid wipe 32x32,bottom right-->top left,inverse	step
	158	Grid wipe 32x32,top right-->bottom left	step
	159	Grid wipe 32x32,top right-->bottom left,inverse	step
	160	4 sliding triangles	step
	161-169	Reserved	
	170	Rectangular ,outside-->in,sharp edge	step
	171	Rectangular ,outside-->in,fuzzy edge 1	step
	172	Rectangular ,outside-->in,fuzzy edge 2	step
	173	Rectangular ,outside-->in,fuzzy edge 3	step
	174	Rectangular ,outside-->in,fuzzy edge 4 (maximum)	step
	175	Rectangular ,inside-->out,sharp edge	step
176	Rectangular ,inside-->out,fuzzy edge 1	step	
177	Rectangular ,inside-->out,fuzzy edge 2	step	
178	Rectangular ,inside-->out,fuzzy edge 3	step	
179	Rectangular ,inside-->out,fuzzy edge 4 (maximum)	step	
180-255	Reserved		
38		Digital Iris	
	0	Open iris	step
	1-254	From max. diameter to min. diameter	proportional
	255	Closed iris	step
39		Digital Iris fine	
	0-255	Iris fine	proportional
40		Digital strobe	
	0 - 30	Open light output	step
	31 - 80	Digital strobe-effect from slow to fast	proportional
	81 - 110	Open light output	step
	111 - 140	Random digital strobe-effect from slow to fast	proportional
	141 - 149	Open light output	step
	150 - 154	Iris displays current gobo from gobo layer 1	step
	155 - 159	Iris displays current gobo from gobo layer 2	step
	160 - 164	Iris displays current gobo from gobo layer 3	step
	165 - 169	Iris displays current gobo from gobo layer 4	step
	170 - 189	Reserved	
	190-194	Banner displays current gobo from gobo layer 1	step
	195-199	Banner displays current gobo from gobo layer 2	step
	200 - 204	Banner displays current gobo from gobo layer 3	step
	205-209	Banner displays current gobo from gobo layer 4	step
210-244	Reserved		
245-255	Digital strobe closed	step	
41		Banner left positioning	

DMX protocol

DMX Channel	DMX Value	Function	Type of control
	0-255	Positioning from left to right (0-default)	proportional
42		Banner left rotation	
	0-255	Rotation +/- 45° (128-default)	proportional
43		Banner right positioning	
	0-255	Positioning from right to left (0-default)	proportional
44		Banner right rotation	
	0-255	Rotation +/- 45° (128-default)	proportional
45		Banner top positioning	
	0-255	Positioning from top to bottom (0-default)	proportional
46		Banner top rotation	
	0-255	Rotation +/- 45° (128-default)	proportional
47		Banner bottom positioning	
	0-255	Positioning from bottom to top (0-default)	proportional
48		Banner bottom rotation	
	0-255	Rotation +/- 45° (128-default)	proportional
49		All Banners rotation	
	0-255	Rotation +/- 45° (128-default)	proportional
50		Global Effect 1	
	0	No effect	step
		<u>Picture merging -selection of width of overlapping edges:</u>	
	1	Width of overlapping edges -10 %	P1, P2, P3
	2	Width of overlapping edges - 0 %	P1, P2, P3
	3	Width of overlapping edges - 15 %	P1, P2, P3
	4	Width of overlapping edges - 20 %	P1, P2, P3
	5	Width of overlapping edges - 25 %	P1, P2, P3
	6	Width of overlapping edges - 30 %	P1, P2, P3
	7	Width of overlapping edges - 35 %	P1, P2, P3
	8-10	Reserved	
		<u>Picture merging -selection of width of overlapping edges for pre-cut content mode:</u>	
	11	Width of overlapping edges -10 %	P1, P2, P3
	12	Width of overlapping edges - 0 %	P1, P2, P3
	13	Width of overlapping edges - 15 %	P1, P2, P3
	14	Width of overlapping edges - 20 %	P1, P2, P3
	15	Width of overlapping edges - 25 %	P1, P2, P3
	16	Width of overlapping edges - 30 %	P1, P2, P3
	17	Width of overlapping edges - 35 %	P1, P2, P3
		<i>P1- field configuration, P2- segment selection, P3- segment edge</i>	
18-255	Reserved		
51		Global effect 1- Parameter 1	
	0	None	
		<u>Image field configuration for Picture merging</u>	
	1-109	Non-mirrored configurations	step
	110-127	Reserved	
	128-163	Horizontally mirrored configurations	step
	164-199	Vertically mirrored configurations	step
	200-235	Horizontally and vertically mirrored configurations	step
236-255	Reserved		
52		Global effect 1- Parameter 2	
	0-255	<u>Segment selection for Pixture merging</u>	step

DMX protocol

DMX Channel	DMX Value	Function	Type of control
53		Global effect 1- Parameter 3	
	0-171	Segment edge display for Pixture merging	step
	172-255	Reserved	
54		Global Effect 2	
	0	None	
	1	Vertical inside corner mapping	P1, P2,P3
	2	Vertical outside corner mapping	P1, P2,P3
	3	Horizontal inside corner mapping	P1, P2,P3
	4	Horizontal outside corner mapping	P1, P2,P3
	5	Vertical convex cylinder mapping	P1, P2,P3
	6	Vertical concave cylinder mapping	P1, P2,P3
	7	Horizontal convex cylinder mapping	P1, P2,P3
	8	Horizontal concave cylinder mapping	P1, P2,P3
	9	Orthographic sphere mapping	P1, P2,P3
	10	Rectangle on circle (sphere) mapping*	P1, P2,P3
	11	Square on circle (sphere) mapping*	P1, P2,P3
	12	Rectangle on circle (sphere) mapping with picture merging	P1, P2,P3
	13-19	Reserved	
20	Picture merging - R/G/B gamma adjustment in blended edges <i>P 1- red, P 2 - green, P 3- blue</i>	P1, P2,P3	
21-255	Reserved		
55		Global Effect 2 - Parameter 1	
	0-255	Function depends on selected Global Effect 2	depends on effect
56		Global Effect 2 - Parameter 2	
	0-255	Function depends on selected Global Effect 2	depends on effect
57		Global Effect 2 - Parameter 3	
	0-255	Function depends on selected Global Effect 2	depends on effect
Gobo layer 1			
58		Dimmer	
	0-255	Dimmer intensity from 0% to 100% (255-default)	proportional
59		Gobo Folder selection	
	0-20	Factory folders	step
	21-240	User folders	step
	241-250	Reserved	
	251	Live input (grab. card)-see channel 60	step
	252	Streaming from remote sources	step
253-255	Reserved		
60		Gobo selection	
	0	White	step
	1-255	255 Gobos (one by one)	step
		If Live input (251 DMX) is selected on channel 59 :	
	0	White screen	step
	1-20	Video composite input-PAL system	step
	21-40	SVIDEO input- PAL system	step
	21-60	Video composite input-NTSC system	step
	61-80	SVIDEO input- NTSC system	step
	81-100	Video composite input-SECAM system	step
	101-120	SVIDEO input- SECAM system	step
121-140	Reserved		

DMX protocol

DMX Channel	DMX Value	Function	Type of control
		<i>If Grabber Card is installed in the fixture</i>	
	141-160	VGA input of DVI/VGA grabber card	step
	161-180	DVI-I input of DVI/VGA grabber card	step
	181-200	SDI input of SDI/ASI grabber card	step
	201-220	ASI input of SDI/ASI grabber card	step
	221-255	Reserved	
61		In Frame High	
	0-255	Defines the beginning of a media file segment as a percentage of the movie length (0-default)	proportional
62		In Frame Low	
	0-255	Defines the beginning of a media file segment as a percentage of the movie length (0-default)	proportional
63		Out Frame High	
	0-255	Defines the end of a media file segment as a percentage of the movie length (255-default)	proportional
64		Out Frame Low	
	0-255	Defines the beginning of a media file segment as a percentage of the movie length (255-default)	proportional
65		Gobo control	
		<u>Copy mode</u>	
		<i>Video stream 1:</i>	
	0	Play forward if dimmer (on layer 1) > 0, looping continuously	step
	1	Play forward if dimmer (on layer 1) > 0, hold on last frame	step
	2	Pause	step
	3	Play forward in continuous loop	step
	4	Play forward once and hold on the last frame	step
	5	No function	
	6	Scrub (Display) the selected In Frame	step
	7	Scrub (Display) the selected Out Frame	step
	8-9	Reserved	
		<i>Video stream 2 (the same functionality as for Video stream 1):</i>	
	10	Play forward if dimmer (on layer 1) > 0, looping continuously	step
	11	Play forward if dimmer (on layer 1) > 0, hold on last frame	step
	12	Pause	step
	13	Play forward in continuous loop	step
	14	Play forward once and hold on the last frame	step
	15	No function	
	16	Scrub (Display) the selected In Frame	step
	17	Scrub (Display) the selected Out Frame	step
	18-19	Reserved	
		<u>Addition mode</u>	
		<i>Video stream 1:</i>	
	20	Play forward if dimmer (on layer 1) > 0, looping continuously	step
	21	Play forward if dimmer (on layer 1) > 0, hold on last frame	step
	22	Pause	step
	23	Play forward in continuous loop	step
	24	Play forward once and hold on the last frame	step
	25	No function	
	26	Scrub (Display) the selected In Frame	step
	27	Scrub (Display) the selected Out Frame	step

DMX protocol

DMX Channel	DMX Value	Function	Type of control
65	28-29	Reserved	
		<i>Video stream 2:</i>	
	30-37	<i>The same functionality as for Video stream 1</i>	step
	38-39	Reserved	
		<u>Substraction mode</u>	
		<i>Video stream 1:</i>	
	40	Play forward if dimmer (on layer 1) > 0, looping continuously	step
	41	Play forward if dimmer (on layer 1) > 0, hold on last frame	step
	42	Pause	step
	43	Play forward in continuous loop	step
	44	Play forward once and hold on the last frame	step
	45	No function	
	46	Scrub (Display) the selected In Frame	step
	47	Scrub (Display) the selected Out Frame	step
	48-49	Reserved	
		<i>Video stream 2:</i>	
	50-57	<i>The same functionality as for Video stream 1</i>	step
	58-59	Reserved	
		<u>Multiplication mode</u>	
		<i>Video stream 1:</i>	
	60	Play forward if dimmer (on layer 1) > 0, looping continuously	step
	61	Play forward if dimmer (on layer 1) > 0, hold on last frame	step
	62	Pause	step
	63	Play forward in continuous loop	step
	64	Play forward once and hold on the last frame	step
	65	No function	
	66	Scrub (Display) the selected In Frame	step
	67	Scrub (Display) the selected Out Frame	step
	68-69	Reserved	
		<i>Video stream 2:</i>	
	70-77	<i>The same functionality as for Video stream 1</i>	step
	78-79	Reserved	
	<u>Minimum mode</u>		
	<i>Video stream 1:</i>		
80	Play forward if dimmer (on layer 1) > 0, looping continuously	step	
81	Play forward if dimmer (on layer 1) > 0, hold on last frame	step	
82	Pause	step	
83	Play forward in continuous loop	step	
84	Play forward once and hold on the last frame	step	
85	No function		
86	Scrub (Display) the selected In Frame	step	
87	Scrub (Display) the selected Out Frame	step	
88-89	Reserved		
	<i>Video stream 2:</i>		
90-97	<i>The same functionality as for Video stream 1</i>		
98-99	Reserved		
	<u>Maximum mode</u>		
	<i>Video stream 1:</i>		
100	Play forward if dimmer (on layer 1) > 0, looping continuously	step	
101	Play forward if dimmer (on layer 1) > 0, hold on last frame	step	

DMX protocol

DMX Channel	DMX Value	Function	Type of control
	102	Pause	step
	103	Play forward in continuous loop	step
	104	Play forward once and hold on the last frame	step
	105	No function	
	106	Scrub (Display) the selected In Frame	step
	107	Scrub (Display) the selected Out Frame	step
	108-109	Reserved	
		<i>Video stream 2:</i>	
	110-117	<i>The same functionality as for Video stream 1</i>	step
	118-255	Reserved	
66		Playback Speed	
	0	Normal Speed	step
	1-127	Slow speeds from slowest ---> normal	proportional
	128	Normal Speed	step
	129-255	Faster than Normal ---> Fastest	proportional
67		Gobo rotation and indexing	
	0-63	Clockwise rotation from fast to slow	proportional
	64-127	Indexing	proportional
	128	No rotation-centre (128-default)	step
	129-192	Indexing	proportional
	193-255	Anticlockwise rotation from slow to fast	proportional
68		Gobo fine indexing (rotation)	
	0-255	Fine indexing (rotation)	proportional
69		Gobo effect 1 Selection	
	0	No effect	
	1	Zoom sinus	P1-speed
	2	Zoom bump in fade out	P1-speed
	3	Zoom fade in bump out	P1-speed
	4	Reserved	
	5	Zoom in fade	P1-speed
	6	Zoom out fade	P1-speed
	7	Scale xy sinus	P1-speed
	8	Reserved	
	9	Reserved	
	10	Reserved	
	11	XY pos. circle counter-clockwise	P1-speed
	12	XY pos. circle clockwise	P1-speed
	13	XY pos. scroll up	P1-speed
	14	XY pos. scroll down	P1-speed
	15	XY pos. scroll left	P1-speed
	16	XY pos. scroll right	P1-speed
	17	Right-left diag. down scroll	P1-speed
	18	Right-left diag. up scroll	P1-speed
	19	Left-right diag. down scroll	P1-speed
	20	Left-right diag. up scroll	P1-speed
	21	X rotate	P1-speed
	22	Y rotate	P1-speed
	23	XY rotate	P1-speed
	24	XY inv. rotate	P1-speed
25	X inv. y rotate	P1-speed	

DMX protocol

DMX Channel	DMX Value	Function	Type of control					
69	26	Tile xy	P1-amount					
	27	Tile xy	P1-speed					
	28	XYZ rot. cube	P1-speed					
	29	XYZ rot. sphere	P1-speed					
	30	X rot. cylinder	P1-speed					
	31	Y rot. cylinder	P1-speed					
	32	Reserved						
	33	Kaleidoscope	none					
	34	Squeeze in	none					
	35	Squeeze out	none					
	36	Bend X	none					
	37	Bend Y	none					
	38	Tile frame	none					
	39	Frame	none					
	40	Plane Flip X	none					
	41	Plane Flip Y	none					
	42	Plane Flip XY	none					
	43	Plane mirror X top	none					
	44	Plane mirror X bottom	none					
	45	Plane mirror Y left	none					
	46	Plane mirror Y right	none					
	47	Plane mirror XY segment 1	<table border="1"> <tr><td>segment 1</td><td>segment 2</td></tr> <tr><td>segment 4</td><td>segment 3</td></tr> </table>	segment 1	segment 2	segment 4	segment 3	none
	segment 1	segment 2						
	segment 4	segment 3						
	48	Plane mirror XY segment 2		none				
	49	Plane mirror XY segment 3	none					
	50	Plane mirror XY segment 4	none					
	51	Plane tile 2x	none					
	52	Plane tile 3x	none					
	53	Plane tile 4x	none					
	54	Plane tile 5x	none					
	55	Plane cross tile 2x	none					
	56	Plane cross tile 2x inverse	none					
	57	Plane cross tile 3x	none					
	58	Plane cross tile 3x inverse	none					
	59	Plane cross tile 4x	none					
	60	Plane cross tile 4x inverse	none					
	61	Plane cross tile 5x	none					
	62	Plane cross tile 5x inverse	none					
	63	Plane cross tiler 5x	none					
	64	Plane cross tiler 5x inverse	none					
	65	Plane bar	none					
	66	Plane bar inverse	none					
	67	Plane bar left-right	none					
	68	Plane bar top-bottom	none					
	69	Reserved						
	70	Reserved						
	71	Gobo disc	none					
	72	Gobo disc Flip X	none					
	73	Gobo disc Flip Y	none					
74	Gobo disc Flip XY	none						
75	Gobo disc mirror X	none						

DMX protocol

DMX Channel	DMX Value	Function	Type of control
	76	Gobo disc mirror Y	none
	77	Gobo disc mirror XY	none
	78-79	Reserved	
	80	Plane mirror X top inverse	none
	81	Plane mirror X bottom inverse	none
	82	Plane mirror Y left inverse	none
	83	Plane mirror Y right inverse	none
	84	Plane mirror XY inverse	none
	85	Plane mirror X-inverse,Y	none
	86	Plane mirror X,Y-inverse	none
	87-89	Reserved	
	90	Circular effect (Fish eye)	P1, P2, P3
		<i>P1-character, P2-X ratio, P3-Y ratio</i>	
	91-99	Reserved	
		<i>kaleidoscope - mode and mosaic segment selection:</i>	
	100	Square -static mode	P1, P2, P3
	101	Square -dynamic mode	P1, P2, P3
	102	Right triangular - static mode	P1, P2, P3
	103	Right triangular - dynamic mode	P1, P2, P3
	104	Isosceles triangular - static mode	P1, P2, P3
	105	Isosceles triangular - dynamic mode	P1, P2, P3
	106	Triangular 1 - static mode	P1, P2, P3
	107	Triangular 1 -dynamic mode	P1, P2, P3
	108	Triangular 2 -static mode	P1, P2, P3
	109	Triangular 2 - dynamic mode	P1, P2, P3
	110	Centered kaleidoscope (rough)-static mode	P1, P2, P3
	111	Centered kaleidoscope (rough)-dynamic mode	P1, P2, P3
	112	Centered kaleidoscope (fine)-static mode	P1, P2, P3
	113	Centered kaleidoscope (fine)-dynamic mode	P1, P2, P3
		<i>Stat. mode:P1-density, P2-content (coarse), P3-content (fine)</i>	
		<i>Dyn. mode:P1-density, P2-size and pulsation, P3-movement</i>	
	114-149	Reserved	
	150	Layer keystoneing	P1,P2,P3
		<i>P1-skewing in X, P2-skewing in Y, P3-squeezing/stretching in Y</i>	
	151-255	Reserved	
70		Gobo effect 1 - Parameter 1	
	0-255	Effect control	depends on effect
71		Gobo effect 1 - Parameter 2	
	0-255	Effect control	depends on effect
72		Gobo effect 1 - Parameter 3	
	0-255	Effect control	depends on effect
73		Gobo effect 2 Selection	
	0	No effect	
	1	Colour to black and white	P1-amount
	2	Colour to black and white inverse	P1-amount
73	3	Black and white to black and white inverse	P1-amount
	4	Inversion	P1-amount
	5	Black Mask	P1-amount
	6	Black Mask inverse	P1-amount
	7	Contrast	P1-amount

DMX protocol

DMX Channel	DMX Value	Function	Type of control	
73	8	Brightness	P1-amount	
	9	RGB to GBR	P1-amount	
	10	RGB to BRG	P1-amount	
	11	RGB to RBG	P1-amount	
	12	Black and white to black and white inverse timed	P1-speed	
	13	Colour to black and white timed	P1-speed	
	14	Colour to inverse timed	P1-speed	
	15	Cycle	P1-speed	
	16	Cycle inverse	P1-speed	
	17	Reserved		
	18	Reserved		
	19	Colour Key	P1-amount	
	20	Colour Key inverse	P1-amount	
	21	Key Black	P1-amount	
	22	Key Black inverse	P1-amount	
	23	Key White	P1-amount	
	24	Key White inverse	P1-amount	
	25	White flash	P1-amount	
	26	Black flash	P1-amount	
	27	Alpha flash	P1-amount	
	28	Invert flash	P1-amount	
	29	BW Flash	P1-amount	
	30	Black and white to black and white inverse Flash	P1-amount	
	31	Gradient Wipe X	P1-amount	
	32	Gradient Wipe Y	P1-amount	
	33-39	Reserved		
	40	Gaussian filter	P1-amount	
	41	Mean filter	P1-amount	
	42	Laplacian filter	P1-amount	
	43	Emboss filter	P1-amount	
	44	Sharpness filter	P1-amount	
	45-49	Reserved		
			RGB effects:	
		50	RGB subtract All Pixels	P1, P2, P3
		51	RGB add All Pixels	P1, P2, P3
		52	RGB add non-black Pixels	P1, P2, P3
		53	RGB subtract/add All Pixels	P1, P2, P3
		54	Swap RGB to RBG	P1, P2, P3
		55	Swap RGB to GRB	P1, P2, P3
		56	Swap RGB to GBR	P1, P2, P3
		57	Swap RGB to BRG	P1, P2, P3
		58	Swap RGB to BGR	P1, P2, P3
		59	RGB invert	P1, P2, P3
		60	Invert and swap RGB to BRG	P1, P2, P3
		61	Invert and swap RGB to GBR	P1, P2, P3
		62	Colour to Alpha	P1, P2, P3
		63	Colour to Alpha inverted	P1, P2, P3
		64-67	Reserved	P1, P2, P3
		68	RGB scale	P1, P2, P3
		<i>P1-red, P2-green, P3-blue</i>		

DMX protocol

DMX Channel	DMX Value	Function	Type of control
	69	Brightness scale	P1, P2
		<i>P1, P2 - inclination of conversion line</i>	
	70-149	<i>Reserved</i>	
	150	<i>Layer keystoneing</i>	P1,P2,P3
		<i>P1-squeezing/stretching in X, P2/P3-compressing & expanding in X/Y</i>	
151-255	Reserved		
74		Gobo effect 2 -Parameter 1	
	0-255	Effect control	depends on effect
75		Gobo effect 2 -Parameter 2	
	0-255	Effect control	depends on effect
76		Gobo effect 2 -Parameter 3	
	0-255	Effect control	depends on effect
77		Gobo Position X coarse	
	0-127	Movement forward	proportional
	128	Centre (128-default)	step
	129-255	Movement backward	proportional
78		Gobo position X fine	
	0-255	Position X fine	proportional
79		Gobo position Y coarse	
	0-127	Movement down	proportional
	128	Centre (128-default)	step
	129-255	Movement up	proportional
80		Gobo position Y fine	
	0-255	Position Y fine	proportional
81		Gobo zoom X coarse	
	0-127	Narrowing	proportional
	128	Centre (128-default)	step
	129-255	Widening	proportional
82		Gobo zoom X fine	
	0-255	Zoom X fine	proportional
83		Gobo zoom Y coarse	
	0-127	Narrowing	proportional
	128	Centre (128-default)	step
	129-255	Widening	proportional
84		Gobo zoom Y fine	
	0-255	Zoom Y fine	proportional
85		Synchronization to ID	
	0	No function	step
	1-255	Synchronization to fixture ID	proportional
Gobo layer 2			
86		Dimmer	
	0-255	Dimmer intensity from 0% to 100% (255-default)	proportional
87		Gobo Folder selection	
	0-20	Factory folders	step
	21-240	User folders	step
	241-250	Reserved	
	251	Live input (grab. card)-see channel 88	step

DMX protocol

DMX Channel	DMX Value	Function	Type of control
	252	Streaming from remote sources	step
	253-255	Reserved	
88		Gobo selection	
	0	White	step
	1-255	255 Gobos (one by one)	step
		<i>If Live input (251 DMX) is selected on channel 87:</i>	
	0	White screen	step
	1-20	Video composite input-PAL system	step
	21-40	SVIDEO input- PAL system	step
	21-60	Video composite input-NTSC system	step
	61-80	SVIDEO input- NTSC system	step
	81-100	Video composite input-SECAM system	step
	101-120	SVIDEO input- SECAM system	step
	121-140	Reserved	
		<i>If Grabber Card is installed in the fixture</i>	
	141-160	VGA input of grabber card	step
	161-180	DVI-I input of grabber card	step
	181-200	SDI input of SDI/ASI grabber card	step
201-220	ASI input of SDI/ASI grabber card	step	
221-255	Reserved		
89		In Frame High	
	0-255	Defines the beginning of a media file segment as a percentage of the movie length (0-default)	proportional
90		In Frame Low	
	0-255	Defines the beginning of a media file segment as a percentage of the movie length (0-default)	proportional
91		Out Frame High	
	0-255	Defines the end of a media file segment as a percentage of the movie length (255-default)	proportional
92		Out Frame Low	
	0-255	Defines the beginning of a media file segment as a percentage of the movie length (255-default)	proportional
93		Gobo control	
		Copy mode	
		<i>Video stream 1</i>	
	0	Play forward if dimmer (on layer 2) > 0, looping continuously	step
	1	Play forward if dimmer (on layer 2) > 0, hold on last frame	step
	2	Pause	step
	3	Play forward in continuous loop	step
	4	Play forward once and hold on the last frame	step
	5	No function	
	6	Scrub (Display) the selected In Frame	step
	7	Scrub (Display) the selected Out Frame	step
	8-9	Reserved	
		<i>Video stream 2 (the same functionality as for Video stream 1):</i>	
	10	Play forward if dimmer (on layer 2) > 0, looping continuously	step
	11	Play forward if dimmer (on layer 2) > 0, hold on last frame	step
12	Pause	step	
13	Play forward in continuous loop	step	
14	Play forward once and hold on the last frame	step	

DMX protocol

DMX Channel	DMX Value	Function	Type of control
93	15	No function	
	16	Scrub (Display) the selected In Frame	step
	17	Scrub (Display) the selected Out Frame	step
	18-19	Reserved	
		<u>Addition mode</u>	
		<i>Video Stream 1</i>	
	20	Play forward if dimmer (on layer 2) > 0, looping continuously	step
	21	Play forward if dimmer (on layer 2) > 0, hold on last frame	step
	22	Pause	step
	23	Play forward in continuous loop	step
	24	Play forward once and hold on the last frame	step
	25	No function	
	26	Scrub (Display) the selected In Frame	step
	27	Scrub (Display) the selected Out Frame	step
	28-29	Reserved	
		<i>Video stream 2</i>	
	30-37	<i>the same functionality as for Video stream 1</i>	step
	38-39	Reserved	
		<u>Substraction mode</u>	
		<i>Video Stream 1</i>	
	40	Play forward if dimmer (on layer 2) > 0, looping continuously	step
	41	Play forward if dimmer (on layer 2) > 0, hold on last frame	step
	42	Pause	step
	43	Play forward in continuous loop	step
	44	Play forward once and hold on the last frame	step
	45	No function	
	46	Scrub (Display) the selected In Frame	step
	47	Scrub (Display) the selected Out Frame	step
	48-49	Reserved	
		<i>Video Stream 2</i>	
	50-57	<i>the same functionality as for Video stream 1</i>	step
	58-59	Reserved	
		<u>Multiplication mode</u>	
		<i>Video stream 1</i>	
	60	Play forward if dimmer (on layer 2) > 0, looping continuously	step
	61	Play forward if dimmer (on layer 2) > 0, hold on last frame	step
	62	Pause	step
	63	Play forward in continuous loop	step
	64	Play forward once and hold on the last frame	step
	65	No function	
	66	Scrub (Display) the selected In Frame	step
	67	Scrub (Display) the selected Out Frame	step
	68-69	Reserved	
		<i>Video Stream 2</i>	
	70-77	<i>the same functionality as for Video stream 1</i>	step
	78-79	Reserved	
		<u>Minimum mode</u>	
	<i>Video stream 1</i>		
80	Play forward if dimmer (on layer 2) > 0, looping continuously	step	
81	Play forward if dimmer (on layer 2) > 0, hold on last frame	step	

DMX protocol

DMX Channel	DMX Value	Function	Type of control
	82	Pause	step
	83	Play forward in continuous loop	step
	84	Play forward once and hold on the last frame	step
	85	No function	
	86	Scrub (Display) the selected In Frame	step
	87	Scrub (Display) the selected Out Frame	step
	88-89	Reserved	
		<i>Video Stream 2</i>	
	90-97	<i>the same functionality as for Video stream 1</i>	step
	98-99	Reserved	
		Maximum mode	
		<i>Video stream 1</i>	
	100	Play forward if dimmer (on layer 2) > 0, looping continuously	step
	101	Play forward if dimmer (on layer 2) > 0, hold on last frame	step
	102	Pause	step
	103	Play forward in continuous loop	step
	104	Play forward once and hold on the last frame	step
	105	No function	
	106	Scrub (Display) the selected In Frame	step
	107	Scrub (Display) the selected Out Frame	step
108-109	Reserved		
	<i>Video Stream 2</i>		
110-117	<i>the same functionality as for Video stream 1</i>	step	
118-255	Reserved		
94		Playback Speed	
	0	Normal Speed	step
	1-127	Slow speeds from slowest ---> normal	proportional
	128	Normal Speed	step
	129-255	Faster than Normal ---> Fastest	proportional
95		Gobo rotation and indexing	
	0-63	Clockwise rotation from fast to slow	proportional
	64-127	Indexing	proportional
	128	No rotation-centre (128-default)	step
	129-192	Indexing	proportional
193-255	Anticlockwise rotation from slow to fast	proportional	
96		Gobo fine indexing (rotation)	
	0-255	Fine indexing (rotation)	proportional
97		Gobo effect 1 Selection	
	0	No effect	
	1	Zoom sinus	P1-speed
	2	Zoom bump in fade out	P1-speed
	3	Zoom fade in bump out	P1-speed
	4	Reserved	
	5	Zoom in fade	P1-speed
	6	Zoom out fade	P1-speed
	7	Scale xy sinus	P1-speed
	8	Reserved	
	9	Reserved	
	10	Reserved	
11	XY pos. circle counter-clockwise	P1-speed	

DMX protocol

DMX Channel	DMX Value	Function	Type of control
	12	XY pos. circle clockwise	P1-speed
	13	XY pos. scroll up	P1-speed
	14	XY pos. scroll down	P1-speed
	15	XY pos. scroll left	P1-speed
	16	XY pos. scroll right	P1-speed
	17	Right-left diag. down scroll	P1-speed
	18	Right-left diag. up scroll	P1-speed
	19	Left-right diag. down scroll	P1-speed
	20	Left-right diag. up scroll	P1-speed
	21	X rotate	P1-speed
	22	Y rotate	P1-speed
	23	XY rotate	P1-speed
	24	XY inv. rotate	P1-speed
	25	X inv. y rotate	P1-speed
	26	Tile xy	P1-amount
	27	Tile xy	P1-speed
	28	XYZ rot. cube	P1-speed
	29	XYZ rot. sphere	P1-speed
	30	X rot. cylinder	P1-speed
	31	Y rot. cylinder	P1-speed
	32	Reserved	
	33	Kaleidoscope	none
	34	Squeeze in	none
	35	Squeeze out	none
	36	Bend X	none
	37	Bend Y	none
	38	Tile frame	none
	39	Frame	none
	40	Plane Flip X	none
	41	Plane Flip Y	none
	42	Plane Flip XY	none
	43	Plane mirror X top	none
	44	Plane mirror X bottom	none
	45	Plane mirror Y left	none
	46	Plane mirror Y right	none
	47	Plane mirror XY segment 1	none
	48	Plane mirror XY segment 2	segment 1 segment 2
	49	Plane mirror XY segment 3	none
	50	Plane mirror XY segment 4	segment 4 segment 3
	51	Plane tile 2x	none
	52	Plane tile 3x	none
	53	Plane tile 4x	none
	54	Plane tile 5x	none
	55	Plane cross tile 2x	none
	56	Plane cross tile 2x inverse	none
	57	Plane cross tile 3x	none
	58	Plane cross tile 3x inverse	none
	59	Plane cross tile 4x	none
	60	Plane cross tile 4x inverse	none
	61	Plane cross tile 5x	none

DMX protocol

DMX Channel	DMX Value	Function	Type of control
97	62	Plane cross tile 5x inverse	none
	63	Plane cross tiler 5x	none
	64	Plane cross tiler 5x inverse	none
	65	Plane bar	none
	66	Plane bar inverse	none
	67	Plane bar left-right	none
	68	Plane bar top-bottom	none
	69	Reserved	
	70	Reserved	
	71	Gobo disc	none
	72	Gobo disc Flip X	none
	73	Gobo disc Flip Y	none
	74	Gobo disc Flip XY	none
	75	Gobo disc mirror X	none
	76	Gobo disc mirror Y	none
	77	Gobo disc mirror XY	none
	78-79	Reserved	
	80	Plane mirror X top inverse	none
	81	Plane mirror X bottom inverse	none
	82	Plane mirror Y left inverse	none
	83	Plane mirror Y right inverse	none
	84	Plane mirror XY inverse	none
	85	Plane mirror X-inverse,Y	none
	86	Plane mirror X,Y-inverse	none
	87-89	Reserved	
	90	Circular effect (Fish eye)	P1, P2, P3
		<i>P1-character, P2-X ratio, P3-Y ratio</i>	
	91-99	Reserved	
		<i>kaleidoscope - mode and mosaic segment selection:</i>	
	100	Square -static mode	P1, P2, P3
	101	Square -dynamic mode	P1, P2, P3
	102	Right triangular - static mode	P1, P2, P3
	103	Right triangular - dynamic mode	P1, P2, P3
	104	Isosceles triangular - static mode	P1, P2, P3
105	Isosceles triangular - dynamic mode	P1, P2, P3	
106	Triangular 1 - static mode	P1, P2, P3	
107	Triangular 1 -dynamic mode	P1, P2, P3	
108	Triangular 2 -static mode	P1, P2, P3	
109	Triangular 2 - dynamic mode	P1, P2, P3	
110	Centered kaleidoscope (rough)-static mode	P1, P2, P3	
111	Centered kaleidoscope (rough)-dynamic mode	P1, P2, P3	
112	Centered kaleidoscope (fine)-static mode	P1, P2, P3	
113	Centered kaleidoscope (fine)-dynamic mode	P1, P2, P3	
	<i>Stat. mode:P1-density, P2-content (coarse), P3-content (fine)</i>		
	<i>Dyn. mode:P1-density, P2-size and pulsation, P3-movement</i>		
114-149	Reserved		
150	Layer keystoneing	P1,P2,P3	
	<i>P1-skewing in X, P2-skewing in Y, P3-squeezing/stretching in Y</i>		
151-255	Reserved		
98		Gobo effect 1 - Parameter 1	

DMX protocol

DMX Channel	DMX Value	Function	Type of control
	0-255	Effect control	depends on effect
99		Gobo effect 1 - Parameter 2	
	0-255	Effect control	depends on effect
100		Gobo effect 1 - Parameter 3	
	0-255	Effect control	depends on effect
101		Gobo effect 2 Selection	
	0	No effect	
	1	Colour to black and white	P1-amount
	2	Colour to black and white inverse	P1-amount
	3	Black and white to black and white inverse	P1-amount
	4	Inversion	P1-amount
	5	Black Mask	P1-amount
	6	Black Mask inverse	P1-amount
	7	Contrast	P1-amount
	8	Brightness	P1-amount
	9	RGB to GBR	P1-amount
	10	RGB to BRG	P1-amount
	11	RGB to RBG	P1-amount
	12	Black and white to black and white inverse timed	P1-speed
	13	Colour to black and white timed	P1-speed
	14	Colour to inverse timed	P1-speed
	15	Cycle	P1-speed
	16	Cycle inverse	P1-speed
	17	Reserved	
	18	Reserved	
	19	Colour Key	P1-amount
	20	Colour Key inverse	P1-amount
	21	Key Black	P1-amount
	22	Key Black inverse	P1-amount
	23	Key White	P1-amount
	24	Key White inverse	P1-amount
	25	White flash	P1-amount
	26	Black flash	P1-amount
	27	Alpha flash	P1-amount
	28	Invert flash	P1-amount
	29	BW Flash	P1-amount
	30	Black and white to black and white inverse Flash	P1-amount
	31	Gradient Wipe X	P1-amount
	32	Gradient Wipe Y	P1-amount
	33-39	Reserved	
	40	Gaussian filter	P1-amount
	41	Mean filter	P1-amount
	42	Laplacian filter	P1-amount
	43	Emboss filter	P1-amount
	44	Sharpness filter	P1-amount
	45-49	Reserved	
		RGB effects:	
	50	RGB subtract All Pixels	P1, P2, P3
	51	RGB add All Pixels	P1, P2, P3
	52	RGB add non-black Pixels	P1, P2, P3

DMX protocol

DMX Channel	DMX Value	Function	Type of control
	53	RGB subtract/add All Pixels	P1, P2, P3
	54	Swap RGB to RBG	P1, P2, P3
	55	Swap RGB to GRB	P1, P2, P3
	56	Swap RGB to GBR	P1, P2, P3
	57	Swap RGB to BRG	P1, P2, P3
	58	Swap RGB to BGR	P1, P2, P3
	59	RGB invert	P1, P2, P3
	60	Invert and swap RGB to BRG	P1, P2, P3
	61	Invert and swap RGB to GBR	P1, P2, P3
	62	Colour to Alpha	P1, P2, P3
	63	Colour to Alpha inverted	P1, P2, P3
	64-67	Reserved	
	68	RGB scale <i>P1-red, P2-green, P3-blue</i>	P1, P2, P3
	69	Brightness scale <i>P1, P2 - inclination of conversion line</i>	P1, P2
	70-149	<i>Reserved</i>	
	150	<i>Layer keystoneing</i> <i>P1-squeezing/stretching in X, P2/P3-compressing & expanding in X/Y</i>	P1,P2,P3
	151-255	Reserved	
102		Gobo effect 2 -Parameter 1	
	0-255	Effect control	depends on effect
103		Gobo effect 2 -Parameter 2	
	0-255	Effect control	depends on effect
104		Gobo effect 2 -Parameter 3	
	0-255	Effect control	depends on effect
105		Gobo Position X coarse	
	0-127	Movement forward	proportional
	128	Centre (128-default)	step
	129-255	Movement backward	proportional
106		Gobo position X fine	
	0-255	Position X fine	proportional
107		Gobo position Y coarse	
	0-127	Movement down	proportional
	128	Centre (128-default)	step
	129-255	Movement up	proportional
108		Gobo position Y fine	
	0-255	Position Y fine	proportional
109		Gobo zoom X coarse	
	0-127	Narrowing	proportional
	128	Centre (128-default)	step
	129-255	Widening	proportional
110		Gobo zoom X fine	
	0-255	Zoom X fine	proportional
111		Gobo zoom Y coarse	
	0-127	Narrowing	proportional
	128	Centre (128-default)	step
	129-255	Widening	proportional
112		Gobo zoom Y fine	

DMX protocol

DMX Channel	DMX Value	Function	Type of control
	0-255	Zoom Y fine	proportional
113		Synchronization to ID	
	0	No function	step
	1-255	Synchronization to fixture ID	proportional
Gobo layer 3			
114		Dimmer	
	0-255	Dimmer intensity from 0% to 100% (255-default)	proportional
115		Gobo Folder selection	
	0-20	Factory folders	step
	21-240	User folders	step
	241-250	Reserved	
	251	Live input (grab. card)-see channel 116	step
	252	Straming from remote sources	step
	253-255	Reserved	
116		Gobo selection	
	0	White	step
	1-255	255 Gobos (one by one)	step
		<i>If Live input (251 DMX) is selected on channel 115:</i>	
	0	White screen	step
	1-20	Video composite input-PAL system	step
	21-40	SVIDEO input- PAL system	step
	21-60	Video composite input-NTSC system	step
	61-80	SVIDEO input- NTSC system	step
	81-100	Video composite input-SECAM system	step
	101-120	SVIDEO input- SECAM system	step
	121-140	Reserved	
		<i>If Grabber Card is installed in the fixture</i>	
	141-160	VGA input of grabber card	step
	161-180	DVI-I input of grabber card	step
	181-200	SDI input of SDI/ASI grabber card	step
	201-220	ASI input of SDI/ASI grabber card	step
221-255	Reserved		
117		In Frame High	
	0-255	Defines the beginning of a media file segment as a percentage of the movie length (0-default)	proportional
118		In Frame Low	
	0-255	Defines the beginning of a media file segment as a percentage of the movie length (0-default)	proportional
119		Out Frame High	
	0-255	Defines the end of a media file segment as a percentage of the movie length (255-default)	proportional
120		Out Frame Low	
	0-255	Defines the beginning of a media file segment as a percentage of the movie length (255-default)	proportional
121		Gobo control	
		<u>Copy mode</u>	
		<i>Video stream 1</i>	
	0	Play forward if dimmer (on layer 3) > 0, looping continuously	step
	1	Play forward if dimmer (on layer 3) > 0, hold on last frame	step

DMX protocol

DMX Channel	DMX Value	Function	Type of control
	2	Pause	step
	3	Play forward in continuous loop	step
	4	Play forward once and hold on the last frame	step
	5	No function	
	6	Scrub (Display) the selected In Frame	step
	7	Scrub (Display) the selected Out Frame	step
	8-9	Reserved	
		<i>Video stream 2 (the same functionality as for Video stream 1):</i>	
	10	Play forward if dimmer (on layer 3) > 0, looping continuously	step
	11	Play forward if dimmer (on layer 3) > 0, hold on last frame	step
	12	Pause	step
	13	Play forward in continuous loop	step
	14	Play forward once and hold on the last frame	step
	15	No function	
	16	Scrub (Display) the selected In Frame	step
	17	Scrub (Display) the selected Out Frame	step
	18-19	Reserved	
		<u>Addition mode</u>	
		<i>Video Stream 1</i>	
	20	Play forward if dimmer (on layer 3) > 0, looping continuously	step
	21	Play forward if dimmer (on layer 3) > 0, hold on last frame	step
	22	Pause	step
	23	Play forward in continuous loop	step
	24	Play forward once and hold on the last frame	step
	25	No function	
	26	Scrub (Display) the selected In Frame	step
	27	Scrub (Display) the selected Out Frame	step
	28-29	Reserved	
		<i>Video stream 2</i>	
	30-37	<i>the same functionality as for Video stream 1</i>	step
	38-39	Reserved	
		<u>Substraction mode</u>	
		<i>Video Stream 1</i>	
	40	Play forward if dimmer (on layer 3) > 0, looping continuously	step
	41	Play forward if dimmer (on layer 3) > 0, hold on last frame	step
	42	Pause	step
	43	Play forward in continuous loop	step
	44	Play forward once and hold on the last frame	step
	45	No function	
	46	Scrub (Display) the selected In Frame	step
	47	Scrub (Display) the selected Out Frame	step
	48-49	Reserved	
		<i>Video Stream 2</i>	
	50-57	<i>the same functionality as for Video stream 1</i>	step
	58-59	Reserved	
		<u>Multiplication mode</u>	
		<i>Video stream 1</i>	
	60	Play forward if dimmer (on layer 3) > 0, looping continuously	step
	61	Play forward if dimmer (on layer 3) > 0, hold on last frame	step
	62	Pause	step

DMX protocol

DMX Channel	DMX Value	Function	Type of control
121	63	Play forward in continuous loop	step
	64	Play forward once and hold on the last frame	step
	65	No function	
	66	Scrub (Display) the selected In Frame	step
	67	Scrub (Display) the selected Out Frame	step
	68-69	Reserved	
		<i>Video Stream 2</i>	
	70-77	<i>the same functionality as for Video stream 1</i>	step
	78-79	Reserved	
		<u>Minimum mode</u>	
		<i>Video stream 1</i>	
	80	Play forward if dimmer (on layer 3) > 0, looping continuously	step
	81	Play forward if dimmer (on layer 3) > 0, hold on last frame	step
	82	Pause	step
	83	Play forward in continuous loop	step
	84	Play forward once and hold on the last frame	step
	85	No function	
	86	Scrub (Display) the selected In Frame	step
	87	Scrub (Display) the selected Out Frame	step
	88-89	Reserved	
		<i>Video Stream 2</i>	
	90-97	<i>the same functionality as for Video stream 1</i>	step
	98-99	Reserved	
		<u>Maximum mode</u>	
		<i>Video stream 1</i>	
	100	Play forward if dimmer (on layer 3) > 0, looping continuously	step
	101	Play forward if dimmer (on layer 3) > 0, hold on last frame	step
	102	Pause	step
	103	Play forward in continuous loop	step
	104	Play forward once and hold on the last frame	step
	105	No function	
	106	Scrub (Display) the selected In Frame	step
107	Scrub (Display) the selected Out Frame	step	
108-109	Reserved		
	<i>Video Stream 2</i>		
110-117	<i>the same functionality as for Video stream 1</i>	step	
118-255	Reserved		
122		Playback Speed	
	0	Normal Speed	step
	1-127	Slow speeds from slowest ---> normal	proportional
	128	Normal Speed	step
	129-255	Faster than Normal ---> Fastest	proportional
123		Gobo rotation and indexing	
	0-63	Clockwise rotation from fast to slow	proportional
	64-127	Indexing	proportional
	128	No rotation-centre (128-default)	step
	129-192	Indexing	proportional
193-255	Anticlockwise rotation from slow to fast	proportional	
124		Gobo fine indexing (rotation)	
	0-255	Fine indexing (rotation)	proportional

DMX protocol

DMX Channel	DMX Value	Function	Type of control	
125		Gobo effect 1 Selection		
	0	No effect		
	1	Zoom sinus	P1-speed	
	2	Zoom bump in fade out	P1-speed	
	3	Zoom fade in bump out	P1-speed	
	4	Reserved		
	5	Zoom in fade	P1-speed	
	6	Zoom out fade	P1-speed	
	7	Scale xy sinus	P1-speed	
	8	Reserved		
	9	Reserved		
	10	Reserved		
	11	XY pos. circle counter-clockwise	P1-speed	
	12	XY pos. circle clockwise	P1-speed	
	13	XY pos. scroll up	P1-speed	
	14	XY pos. scroll down	P1-speed	
	15	XY pos. scroll left	P1-speed	
	16	XY pos. scroll right	P1-speed	
	17	Right-left diag. down scroll	P1-speed	
	18	Right-left diag. up scroll	P1-speed	
	19	Left-right diag. down scroll	P1-speed	
	20	Left-right diag. up scroll	P1-speed	
	21	X rotate	P1-speed	
	22	Y rotate	P1-speed	
	23	XY rotate	P1-speed	
	24	XY inv. rotate	P1-speed	
	25	X inv. y rotate	P1-speed	
	26	Tile xy	P1-amount	
	27	Tile xy	P1-speed	
	28	XYZ rot. cube	P1-speed	
	29	XYZ rot. sphere	P1-speed	
	30	X rot. cylinder	P1-speed	
	31	Y rot. cylinder	P1-speed	
	32	Reserved		
	33	Kaleidoscope	P1-speed	
	34	Squeeze in	P1-speed	
	35	Squeeze out	P1-speed	
	36	Bend X	P1-speed	
	37	Bend Y	P1-speed	
	38	Tile frame	P1-speed	
	39	Frame	P1-speed	
	125	40	Plane Flip X	P1-speed
		41	Plane Flip Y	P1-speed
		42	Plane Flip XY	P1-speed
		43	Plane mirror X top	P1-speed
		44	Plane mirror X bottom	P1-speed
		45	Plane mirror Y left	P1-speed
		46	Plane mirror Y right	P1-speed
47		Plane mirror XY segment 1	P1-speed	
48		Plane mirror XY segment 2	P1-speed	
		segment 1	segment 2	

DMX protocol

DMX Channel	DMX Value	Function	Type of control
	49	Plane mirror XY segment 3	P1-speed
	50	Plane mirror XY segment 4	P1-speed
	51	Plane tile 2x	P1-speed
	52	Plane tile 3x	P1-speed
	53	Plane tile 4x	P1-speed
	54	Plane tile 5x	P1-speed
	55	Plane cross tile 2x	P1-speed
	56	Plane cross tile 2x inverse	P1-speed
	57	Plane cross tile 3x	P1-speed
	58	Plane cross tile 3x inverse	P1-speed
	59	Plane cross tile 4x	P1-speed
	60	Plane cross tile 4x inverse	P1-speed
	61	Plane cross tile 5x	P1-speed
	62	Plane cross tile 5x inverse	P1-speed
	63	Plane cross tiler 5x	P1-speed
	64	Plane cross tiler 5x inverse	P1-speed
	65	Plane bar	P1-speed
	66	Plane bar inverse	P1-speed
	67	Plane bar left-right	P1-speed
	68	Plane bar top-bottom	P1-speed
	69	Reserved	
	70	Reserved	
	71	Gobo disc	none
	72	Gobo disc Flip X	none
	73	Gobo disc Flip Y	none
	74	Gobo disc Flip XY	none
	75	Gobo disc mirror X	none
	76	Gobo disc mirror Y	none
	77	Gobo disc mirror XY	none
	78-79	Reserved	
	80	Plane mirror X top inverse	none
	81	Plane mirror X bottom inverse	none
	82	Plane mirror Y left inverse	none
	83	Plane mirror Y right inverse	none
	84	Plane mirror XY inverse	none
	85	Plane mirror X-inverse,Y	none
	86	Plane mirror X,Y-inverse	none
	87-89	Reserved	
	90	Circular effect (Fish eye)	P1, P2, P3
		<i>P1-character, P2-X ratio, P3-Y ratio</i>	
	91-99	Reserved	
		<i>kaleidoscope - mode and mosaic segment selection:</i>	
	100	Square -static mode	P1, P2, P3
	101	Square -dynamic mode	P1, P2, P3
	102	Right triangular - static mode	P1, P2, P3
	103	Right triangular - dynamic mode	P1, P2, P3
	104	Isosceles triangular - static mode	P1, P2, P3
	105	Isosceles triangular - dynamic mode	P1, P2, P3
	106	Triangular 1 - static mode	P1, P2, P3
	107	Triangular 1 -dynamic mode	P1, P2, P3

DMX protocol

DMX Channel	DMX Value	Function	Type of control
	108	Triangular 2 -static mode	P1, P2, P3
	109	Triangular 2 - dynamic mode	P1, P2, P3
	110	Centered mosaic (rough)-static mode	P1, P2, P3
	111	Centered mosaic (rough)-dynamic mode	P1, P2, P3
	112	Centered mosaic (fine)-static mode	P1, P2, P3
	113	Centered mosaic (fine)-dynamic mode	P1, P2, P3
		<i>Stat. mode:P1-density, P2-content (coarse), P3-content (fine)</i>	
		<i>Dyn. mode:P1-density, P2-size and pulsation, P3-movement</i>	
	114-149	Reserved	
	150	Layer keystoneing	P1,P2,P3
		<i>P1-skewing in X, P2-skewing in Y, P3-squeezing/stretching in Y</i>	
151-255	Reserved		
126		Gobo effect 1 - Parameter 1	
	0 - 255	Effect control	depends on effect
127		Gobo effect 1 - Parameter 2	
	0 - 255	Effect control	depends on effect
128		Gobo effect 1 - Parameter 3	
	0 - 255	Effect control	depends on effect
129		Gobo effect 2 Selection	
	0	No effect	
	1	Colour to black and white	P1-amount
	2	Colour to black and white inverse	P1-amount
	3	Black and white to black and white inverse	P1-amount
	4	Inversion	P1-amount
	5	Black Mask	P1-amount
	6	Black Mask inverse	P1-amount
	7	Contrast	P1-amount
	8	Brightness	P1-amount
	9	RGB to GBR	P1-amount
	10	RGB to BRG	P1-amount
	11	RGB to RBG	P1-amount
	12	Black and white to black and white inverse timed	P1-speed
	13	Colour to black and white timed	P1-speed
	14	Colour to inverse timed	P1-speed
	15	Cycle	P1-speed
	16	Cycle inverse	P1-speed
	17	Reserved	
	18	Reserved	
	19	Colour Key	P1-amount
	20	Colour Key inverse	P1-amount
	21	Key Black	P1-amount
	22	Key Black inverse	P1-amount
	23	Key White	P1-amount
	24	Key White inverse	P1-amount
	25	White flash	P1-amount
	26	Black flash	P1-amount
	27	Alpha flash	P1-amount
	28	Invert flash	P1-amount
	29	BW Flash	P1-amount
	30	Black and white to black and white inverse Flash	P1-amount

DMX protocol

DMX Channel	DMX Value	Function	Type of control
	31	Gradient Wipe X	P1-amount
	32	Gradient Wipe Y	P1-amount
	33-39	Reserved	
	40	Gaussian filter	P1-amount
	41	Mean filter	P1-amount
	42	Laplacian filter	P1-amount
	43	Emboss filter	P1-amount
	44	Sharpness filter	P1-amount
	45-49	Reserved	
		RGB effects:	
	50	RGB subtract All Pixels	P1, P2, P3
	51	RGB add All Pixels	P1, P2, P3
	52	RGB add non-black Pixels	P1, P2, P3
	53	RGB subtract/add All Pixels	P1, P2, P3
	54	Swap RGB to RBG	P1, P2, P3
	55	Swap RGB to GRB	P1, P2, P3
	56	Swap RGB to GBR	P1, P2, P3
	57	Swap RGB to BRG	P1, P2, P3
	58	Swap RGB to BGR	P1, P2, P3
	59	RGB invert	P1, P2, P3
	60	Invert and swap RGB to BRG	P1, P2, P3
	61	Invert and swap RGB to GBR	P1, P2, P3
	62	Colour to Alpha	P1, P2, P3
	63	Colour to Alpha inverted	P1, P2, P3
	64-67	Reserved	
	68	RGB scale	P1, P2, P3
		<i>P1-red, P2-green, P3-blue</i>	
	69	Brightness scale	P1, P2
		<i>P1, P2 - inclination of conversion line</i>	
70-149	Reserved		
150	Layer keystoneing	P1,P2,P3	
	<i>P1-squeezing/stretching in X, P2/P3-compressing & expanding in X/Y</i>		
151-255	Reserved		
130		Gobo effect 2 -Parameter 1	
	0-255	Effect control	depends on effect
131		Gobo effect 2 -Parameter 2	
	0-255	Effect control	depends on effect
132		Gobo effect 2 -Parameter 3	
	0-255	Effect control	depends on effect
133		Gobo Position X coarse	
	0-127	Movement forward	proportional
	128	Centre (128-default)	step
	129-255	Movement backward	proportional
134		Gobo position X fine	
	0-255	Position X fine	proportional
135		Gobo position Y coarse	
	0-127	Movement down	proportional
	128	Centre (128-default)	step
	129-255	Movement up	proportional
136		Gobo position Y fine	

DMX protocol

DMX Channel	DMX Value	Function	Type of control
	0-255	Position Y fine	proportional
137		Gobo zoom X coarse	
	0-127	Narrowing	proportional
	128	Centre (128-default)	step
	129-255	Widening	proportional
138		Gobo zoom X fine	
	0-255	Zoom X fine	proportional
139		Gobo zoom Y coarse	
	0-127	Narrowing	proportional
	128	Centre (128-default)	step
	129-255	Widening	proportional
140		Gobo zoom Y fine	
	0-255	Zoom Y fine	proportional
141		Synchronization to ID	
	0	No function	step
	1-255	Synchronization to fixture ID	proportional
Gobo layer 4			
142		Dimmer	
	0-255	Dimmer intensity from 0% to 100% (255-default)	proportional
143		Gobo Folder selection	
	0-20	Factory folders	step
	21-240	User folders	step
	241-250	Reserved	
	251	Live input (grab. card)-see channel 144	step
	252	Straming from remote sources	step
	253-255	Reserved	
144		Gobo selection	
	0	White	step
	1-255	255 Gobos (one by one)	step
		If Live input (251 DMX) is selected on channel 143:	
	0	White screen	step
	1-20	Video composite input-PAL system	step
	21-40	SVIDEO input- PAL system	step
	21-60	Video composite input-NTSC system	step
	61-80	SVIDEO input- NTSC system	step
	81-100	Video composite input-SECAM system	step
	101-120	SVIDEO input- SECAM system	step
	121-140	Reserved	
		If Grabber Card is installed in the fixture	
	141-160	VGA input of grabber card	step
	161-180	DVI-I input of grabber card	step
	181-200	SDI input of SDI/ASI grabber card	step
	201-220	ASI input of SDI/ASI grabber card	step
221-255	Reserved		
145		In Frame High	
	0-255	Defines the beginning of a media file segment as a percentage of the movie length (0-default)	proportional
146		In Frame Low	

DMX protocol

DMX Channel	DMX Value	Function	Type of control
	0-255	Defines the beginning of a media file segment as a percentage of the movie length (0-default)	proportional
147		Out Frame High	
	0-255	Defines the end of a media file segment as a percentage of the movie length (255-default)	proportional
148		Out Frame Low	
	0-255	Defines the beginning of a media file segment as a percentage of the movie length (255-default)	proportional
149		Gobo control	
		<u>Copy mode</u>	
		<i>Video stream 1</i>	
	0	Play forward if dimmer (on layer 4) > 0, looping continuously	step
	1	Play forward if dimmer (on layer 4) > 0, hold on last frame	step
	2	Pause	step
	3	Play forward in continuous loop	step
	4	Play forward once and hold on the last frame	step
	5	No function	
	6	Scrub (Display) the selected In Frame	step
	7	Scrub (Display) the selected Out Frame	step
	8-9	Reserved	
		<i>Video stream 2 (the same functionality as for Video stream 1):</i>	
	10	Play forward if dimmer (on layer 3) > 0, looping continuously	step
	11	Play forward if dimmer (on layer 3) > 0, hold on last frame	step
	12	Pause	step
	13	Play forward in continuous loop	step
	14	Play forward once and hold on the last frame	step
	15	No function	
	16	Scrub (Display) the selected In Frame	step
	17	Scrub (Display) the selected Out Frame	step
	18-19	Reserved	
		<u>Addition mode</u>	
		<i>Video Stream 1</i>	
	20	Play forward if dimmer (on layer 4) > 0, looping continuously	step
	21	Play forward if dimmer (on layer 4) > 0, hold on last frame	step
	22	Pause	step
	23	Play forward in continuous loop	step
	24	Play forward once and hold on the last frame	step
	25	No function	
	26	Scrub (Display) the selected In Frame	step
	27	Scrub (Display) the selected Out Frame	step
	28-29	Reserved	
	<i>Video stream 2</i>		
30-37	<i>the same functionality as for Video stream 1</i>	step	
38-39	Reserved		
	<u>Substraction mode</u>		
	<i>Video Stream 1</i>		
40	Play forward if dimmer (on layer 4) > 0, looping continuously	step	
41	Play forward if dimmer (on layer 4) > 0, hold on last frame	step	
42	Pause	step	
43	Play forward in continuous loop	step	

DMX protocol

DMX Channel	DMX Value	Function	Type of control
149	44	Play forward once and hold on the last frame	step
	45	No function	
	46	Scrub (Display) the selected In Frame	step
	47	Scrub (Display) the selected Out Frame	step
	48-49	Reserved	
		<i>Video Stream 2</i>	
	50-57	<i>the same functionality as for Video stream 1</i>	step
	58-59	Reserved	
		<u>Multiplication mode</u>	
		<i>Video stream 1</i>	
	60	Play forward if dimmer (on layer 4) > 0, looping continuously	step
	61	Play forward if dimmer (on layer 4) > 0, hold on last frame	step
	62	Pause	step
	63	Play forward in continuous loop	step
	64	Play forward once and hold on the last frame	step
	65	No function	
	66	Scrub (Display) the selected In Frame	step
	67	Scrub (Display) the selected Out Frame	step
	68-69	Reserved	
		<i>Video Stream 2</i>	
	70-77	<i>the same functionality as for Video stream 1</i>	step
	78-79	Reserved	
		<u>Minimum mode</u>	
		<i>Video stream 1</i>	
	80	Play forward if dimmer (on layer 4) > 0, looping continuously	step
	81	Play forward if dimmer (on layer 4) > 0, hold on last frame	step
	82	Pause	step
	83	Play forward in continuous loop	step
	84	Play forward once and hold on the last frame	step
	85	No function	
	86	Scrub (Display) the selected In Frame	step
	87	Scrub (Display) the selected Out Frame	step
	88-89	Reserved	
		<i>Video Stream 2</i>	
	90-97	<i>the same functionality as for Video stream 1</i>	step
	98-99	Reserved	
		<u>Maximum mode</u>	
		<i>Video stream 1</i>	
	100	Play forward if dimmer (on layer 4) > 0, looping continuously	step
	101	Play forward if dimmer (on layer 4) > 0, hold on last frame	step
	102	Pause	step
	103	Play forward in continuous loop	step
	104	Play forward once and hold on the last frame	step
	105	No function	
	106	Scrub (Display) the selected In Frame	step
	107	Scrub (Display) the selected Out Frame	step
	108-109	Reserved	
	<i>Video Stream 2</i>		
110-117	<i>the same functionality as for Video stream 1</i>	step	
118-255	Reserved		

DMX protocol

DMX Channel	DMX Value	Function	Type of control
150		Playback Speed	
	0	Normal Speed	step
	1-127	Slow speeds from slowest ---> normal	proportional
	128	Normal Speed	step
	129-255	Faster than Normal ---> Fastest	proportional
151		Gobo rotation and indexing	
	0-63	Clockwise rotation from fast to slow	proportional
	64-127	Indexing	proportional
	128	No rotation-centre (128-default)	step
	129-192	Indexing	proportional
	193-255	Anticlockwise rotation from slow to fast	proportional
152		Gobo fine indexing (rotation)	
	0-255	Fine indexing (rotation)	proportional
153		Gobo effect 1 Selection	
	0	No effect	
	1	Zoom sinus	P1-speed
	2	Zoom bump in fade out	P1-speed
	3	Zoom fade in bump out	P1-speed
	4	Reserved	
	5	Zoom in fade	P1-speed
	6	Zoom out fade	P1-speed
	7	Scale xy sinus	P1-speed
	8	Reserved	
	9	Reserved	
	10	Reserved	
	11	XY pos. circle counter-clockwise	P1-speed
	12	XY pos. circle clockwise	P1-speed
	13	XY pos. scroll up	P1-speed
	14	XY pos. scroll down	P1-speed
	15	XY pos. scroll left	P1-speed
	16	XY pos. scroll right	P1-speed
	17	Right-left diag. down scroll	P1-speed
	18	Right-left diag. up scroll	P1-speed
	19	Left-right diag. down scroll	P1-speed
	20	Left-right diag. up scroll	P1-speed
	21	X rotate	P1-speed
	22	Y rotate	P1-speed
	23	XY rotate	P1-speed
	24	XY inv. rotate	P1-speed
	25	X inv. y rotate	P1-speed
	26	Tile xy	P1-amount
	27	Tile xy	P1-speed
	28	XYZ rot. cube	P1-speed
	29	XYZ rot. sphere	P1-speed
	30	X rot. cylinder	P1-speed
	31	Y rot. cylinder	P1-speed
	32	Reserved	
	33	Kaleidoscope	none
34	Squeeze in	none	
35	Squeeze out	none	

DMX protocol

DMX Channel	DMX Value	Function	Type of control					
153	36	Bend X	none					
	37	Bend Y	none					
	38	Tile frame	none					
	39	Frame	none					
	40	Plane Flip X	none					
	41	Plane Flip Y	none					
	42	Plane Flip XY	none					
	43	Plane mirror X top	none					
	44	Plane mirror X bottom	none					
	45	Plane mirror Y left	none					
	46	Plane mirror Y right	none					
	47	Plane mirror XY segment 1	<table border="1"> <tr><td>segment 1</td><td>segment 2</td></tr> <tr><td>segment 4</td><td>segment 3</td></tr> </table>	segment 1	segment 2	segment 4	segment 3	none
	segment 1	segment 2						
	segment 4	segment 3						
	48	Plane mirror XY segment 2		none				
	49	Plane mirror XY segment 3	none					
	50	Plane mirror XY segment 4	none					
	51	Plane tile 2x	none					
	52	Plane tile 3x	none					
	53	Plane tile 4x	none					
	54	Plane tile 5x	none					
	55	Plane cross tile 2x	none					
	56	Plane cross tile 2x inverse	none					
	57	Plane cross tile 3x	none					
	58	Plane cross tile 3x inverse	none					
	59	Plane cross tile 4x	none					
	60	Plane cross tile 4x inverse	none					
	61	Plane cross tile 5x	none					
	62	Plane cross tile 5x inverse	none					
	63	Plane cross tiler 5x	none					
	64	Plane cross tiler 5x inverse	none					
	65	Plane bar	none					
	66	Plane bar inverse	none					
	67	Plane bar left-right	none					
	68	Plane bar top-bottom	none					
	69	Reserved						
	70	Reserved						
	71	Gobo disc	none					
	72	Gobo disc Flip X	none					
	73	Gobo disc Flip Y	none					
	74	Gobo disc Flip XY	none					
	75	Gobo disc mirror X	none					
	76	Gobo disc mirror Y	none					
	77	Gobo disc mirror XY	none					
	78-79	Reserved						
	80	Plane mirror X top inverse	none					
	81	Plane mirror X bottom inverse	none					
	82	Plane mirror Y left inverse	none					
	83	Plane mirror Y right inverse	none					
	84	Plane mirror XY inverse	none					
	85	Plane mirror X-inverse,Y	none					
86	Plane mirror X,Y-inverse	none						

DMX protocol

DMX Channel	DMX Value	Function	Type of control
	87-89	Reserved	
	90	Circular effect (Fish eye) <i>P1-character, P2-X ratio, P3-Y ratio</i>	P1, P2, P3
	91-99	Reserved	
		<i>kaleidoscope - mode and mosaic segment selection:</i>	
	100	Square -static mode	P1, P2, P3
	101	Square -dynamic mode	P1, P2, P3
	102	Right triangular - static mode	P1, P2, P3
	103	Right triangular - dynamic mode	P1, P2, P3
	104	Isosceles triangular - static mode	P1, P2, P3
	105	Isosceles triangular - dynamic mode	P1, P2, P3
	106	Triangular 1 - static mode	P1, P2, P3
	107	Triangular 1 -dynamic mode	P1, P2, P3
	108	Triangular 2 -static mode	P1, P2, P3
	109	Triangular 2 - dynamic mode	P1, P2, P3
	110	Centered kaleidoscope (rough)-static mode	P1, P2, P3
	111	Centered kaleidoscope (rough)-dynamic mode	P1, P2, P3
	112	Centered kaleidoscope (fine)-static mode	P1, P2, P3
	113	Centered kaleidoscope (fine)-dynamic mode	P1, P2, P3
		<i>Stat. mode:P1-density, P2-content (coarse), P3-content (fine)</i>	
		<i>Dyn. mode:P1-density, P2-size and pulsation, P3-movement</i>	
114-149	Reserved		
150	Layer keystoneing <i>P1-skewing in X, P2-skewing in Y, P3-squeezing/stretching in Y</i>	P1,P2,P3	
151-255	Reserved		
154		Gobo effect 1 - Parameter 1	
	0 - 255	Effect control	depends on effect
155		Gobo effect 1 - Parameter 2	
	0 - 255	Effect control	depends on effect
156		Gobo effect 1 - Parameter 3	
	0 - 255	Effect control	depends on effect
157		Gobo effect 2 Selection	
	0	No effect	
	1	Colour to black and white	P1-amount
	2	Colour to black and white inverse	P1-amount
	3	Black and white to black and white inverse	P1-amount
	4	Inversion	P1-amount
	5	Black Mask	P1-amount
	6	Black Mask inverse	P1-amount
	7	Contrast	P1-amount
	8	Brightness	P1-amount
	9	RGB to GBR	P1-amount
	10	RGB to BRG	P1-amount
	11	RGB to RBG	P1-amount
	12	Black and white to black and white inverse timed	P1-speed
	13	Colour to black and white timed	P1-speed
	14	Colour to inverse timed	P1-speed
	15	Cycle	P1-speed
	16	Cycle inverse	P1-speed
	17	Reserved	

DMX protocol

DMX Channel	DMX Value	Function	Type of control	
157	18	Reserved		
	19	Colour Key	P1-amount	
	20	Colour Key inverse	P1-amount	
	21	Key Black	P1-amount	
	22	Key Black inverse	P1-amount	
	23	Key White	P1-amount	
	24	Key White inverse	P1-amount	
	25	White flash	P1-amount	
	26	Black flash	P1-amount	
	27	Alpha flash	P1-amount	
	28	Invert flash	P1-amount	
	29	BW Flash	P1-amount	
	30	Black and white to black and white inverse Flash	P1-amount	
	157	31	Gradient Wipe X	P1-amount
		32	Gradient Wipe Y	P1-amount
		33-39	Reserved	
		40	Gaussian filter	P1-amount
41		Mean filter	P1-amount	
42		Laplacian filter	P1-amount	
43		Emboss filter	P1-amount	
44		Sharpness filter	P1-amount	
45-49		Reserved		
		RGB effects:		
	50	RGB subtract All Pixels	P1, P2, P3	
	51	RGB add All Pixels	P1, P2, P3	
	52	RGB add non-black Pixels	P1, P2, P3	
	53	RGB subtract/add All Pixels	P1, P2, P3	
	54	Swap RGB to RBG	P1, P2, P3	
	55	Swap RGB to GRB	P1, P2, P3	
	56	Swap RGB to GBR	P1, P2, P3	
	57	Swap RGB to BRG	P1, P2, P3	
	58	Swap RGB to BGR	P1, P2, P3	
	59	RGB invert	P1, P2, P3	
	60	Invert and swap RGB to BRG	P1, P2, P3	
	61	Invert and swap RGB to GBR	P1, P2, P3	
	62	Colour to Alpha	P1, P2, P3	
	63	Colour to Alpha inverted	P1, P2, P3	
	64-67	Reserved		
	68	RGB scale	P1, P2, P3	
		<i>P1-red, P2-green, P3-blue</i>		
	69	Brightness scale	P1, P2	
		<i>P1, P2 - inclination of conversion line</i>		
	70-149	Reserved		
	150	Layer keystoneing	P1,P2,P3	
		<i>P1-squeezing/stretching in X, P2/P3-compressing & expanding in X/Y</i>		
	151-255	Reserved		
158		Gobo effect 2 -Parameter 1		
	0-255	Effect control	depends on effect	
159		Gobo effect 2 -Parameter 2		

DMX protocol

DMX Channel	DMX Value	Function	Type of control
	0-255	Effect control	depends on effect
160		Gobo effect 2 -Parameter 3	
	0-255	Effect control	depends on effect
161		Gobo Position X coarse	
	0-127	Movement forward	proportional
	128	Centre (128-default)	step
	129-255	Movement backward	proportional
162		Gobo position X fine	
	0-255	Position X fine	proportional
163		Gobo position Y coarse	
	0-127	Movement down	proportional
	128	Centre (128-default)	step
	129-255	Movement up	proportional
164		Gobo position Y fine	
	0-255	Position Y fine	proportional
165		Gobo zoom X coarse	
	0-127	Narrowing	proportional
	128	Centre (128-default)	step
	129-255	Widening	proportional
166		Gobo zoom X fine	
	0-255	Zoom X fine	proportional
167		Gobo zoom Y coarse	
	0-127	Narrowing	proportional
	128	Centre (128-default)	step
	129-255	Widening	proportional
168		Gobo zoom Y fine	
	0-255	Zoom Y fine	proportional
169		Synchronization to ID	
	0	No function	step
169	1-255	Synchronization to fixture ID	proportional
* DMX value 10 and 11 changes meaning of channels 23-30.			
See chapter "Projection onto angular, cylindric or spheric surfaces" in the User manual.			