

D-POWER 4

A



CLIP



I-OUT



SIGNAL



ON

B



CLIP



I-OUT



SIGNAL



ON

PM



MB



CAMCO

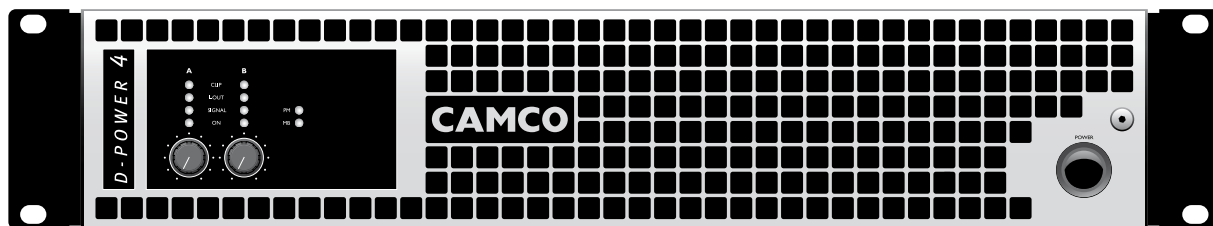

**INFORMATION FOR USE FOR MODELS
D-POWER 2, D-POWER 3 and D-POWER 4**

DUM_GB_2009-R2_06-2009

© Copyright 2009 by **CAMCO** Produktions- und Vertriebs-GmbH
für Beschallungs- und Beleuchtungsanlagen
Fischpicke 5, D-57482 Wenden, Germany
Telephone +49 (0) 2762 408-0

D - POWER SERIES



IMPORTANT SAFETY INSTRUCTIONS

- 1) Read the information for use (user manual).
- 2) Please keep this user manual in a safe place during the lifetime of the amplifier. The user manual forms an integral part of the amplifier. Reselling of the amplifier is only possible if the user manual is available. Any changes made to the amplifier have to be documented in writing and passed on to the buyer in the event of resale.
- 3) Heed all warnings.
- 4) Follow all instructions.
- 5) Do not expose this device to rain or moisture. Do not use this amplifier near water (for example, swimming pools and fountains). Do not place any objects containing liquids, such as bottles or glasses, on the top of the unit. Do not splash liquids on the unit. IP-20 equipment. No Protection against splashing water.
- 6) Clean only with dry cloth.
- 7) Do not block any ventilation openings. Install in accordance with the user manual.
- 8) Do not install near any heat sources such as radiators, heat registers, stoves or other apparatus that produce heat.
- 9) Protect the power cord from being walked on, pinched or damaged in any other way. Pay particular attention to plugs and the point where they exit from the amplifier.

10) The amplifier may only be used in accordance with the information provided in the user manual. Before and during the usage of the amplifier please ensure that all recommendations, especially the safety recommendations as detailed in the user manual, are adhered to.

The **D-POWER** Amplifier is designed for the amplification of pulsed audio signals and the amplifier should only be connected to speakers with an average impedance as indicated.



11) Do not place this amplifier on an unstable cart, stand, tripod, bracket or table. The device may fall, causing serious injury and serious damage to the device itself.

12) The amplifier can only be disconnected from the power supply by removing the plug which must be freely accessible at all times. Unplug this amplifier during lightning storms or when unused for long periods of time.

13) Refer all servicing to qualified service personnel.

Servicing is required when

- the power-supply cord or plug has been damaged,
- liquid has been spilled or objects have fallen into the amplifier,
- the amplifier has been exposed to rain or moisture,
- the amplifier has been dropped or suffered damage in any other way,
- the amplifier exhibits a distinct change from its normal function or performance.



CAUTION
RISK OF ELECTRIC SHOCK
DO NOT OPEN



CAUTION – HIGH VOLTAGE HAZARDS
EXIST WITHIN THIS PRODUCT.
REFER ALL SERVICING TO
AUTHORISED PERSONNEL.



THE LIGHTNING FLASH WITH ARROW HEAD SYMBOL IS INTENDED TO
ALERT THE USER TO THE PRESENCE OF UNINSULATED DANGEROUS
VOLTAGE WITHIN THE PRODUCT'S ENCLOSURE.



THE EXCLAMATION MARK IS INTENDED TO ALERT THE USER
TO IMPORTANT INSTRUCTIONS ALSO FOR MAINTENANCE IN THE
LITERATURE ACCOMPANYING THE AMPLIFIER.



THE LIGHTNING FLASH WITH ARROW HEAD SYMBOL ALERTS THE
USER TO DANGEROUSLY HIGH VOLTAGE AT THE OUTPUT CONNECTORS
THAT COULD POTENTIALLY BE LIFE THREATENING.

CAUTION – RISK OF ELECTRIC SHOCK – DO NOT OPEN.

WARNING – TO PREVENT FIRE OR SHOCK HAZARD, DO NOT EXPOSE THIS
AMPLIFIER TO RAIN OR MOISTURE.



THE AMPLIFIER MAY ONLY BE CONNECTED
TO A SOCKET WITH A PROTECTIVE EARTH CONDUCTOR.

1. Read the information for use (user manual)

When shipping the **D-POWER** amplifier always use the original shipping carton and packing materials. For maximum protection repack the unit as it was originally packed at the factory.

2. Environments

Use this amplifier only in E1, E2, E3 or E4 environments according to EN55103-2 "Electromagnetic compatibility – Product family standard for audio, video and audio-visual and entertainment lighting control apparatus for professional use – Part 2: Immunity"

3. Ventilation

Slots and openings in the cabinet are provided for ventilation to ensure reliable operation of the amplifier and to protect it from overheating. These openings must not be blocked or covered. This amplifier should not be installed unless proper ventilation is provided or manufacturer's instructions have been adhered to.

4. Water and Moisture

Do not expose this device to rain or moisture. Do not use this amplifier near water (for example, swimming pools and fountains). Do not place any objects containing liquids, such as bottles or glasses, on the top of the unit. Do not splash liquids on the unit. IP-20 equipment. No Protection against splashing water.

5. Cleaning

Unplug this amplifier from the wall outlet before cleaning. Do not use liquid or aerosol cleaners.

6. Power-cord Protection

Power-supply cords should be routed so that they are not likely to be walked on or pinched by items placed upon them or against them, paying particular attention to cords and plugs and the point where they exit from the amplifier.



7. Lightning

For added protection of this amplifier during lightning storms or when it is left unattended and unused for long periods of time, unplug it from the wall outlet. This will prevent damage to the amplifier due to lightning and power-line surges. Disconnection from the mains power supply can only be achieved by removing the plug from the mains socket and by external disconnecting all poles from the mains.

8. Interference of external objects and/or liquids with the appliance

Never push objects of any kind into this amplifier through openings as they may touch dangerous voltage points or short out parts that could result in a fire or electric shock. Never spill liquid of any kind on the amplifier.

9. Accessories

Do not place this amplifier on an unstable cart, stand, tripod, bracket or table. The amplifier may fall, causing serious injury and serious damage to the product. Any mounting of the amplifier should follow the manufacturers instructions and should use a mounting accessory recommended by the manufacturer.

10. Connecting

When you connect the amplifier to other equipment turn off the power and unplug all of the equipment from the supply source. Failure to do so may cause an electric shock and serious personal injury. Read the user manual of the other equipment carefully and follow the instructions when making the connections.

11. Sound Volume

Reduce the volume to minimum before you turn on the amplifier to prevent sudden high levels of noise which may cause hearing or speaker damage.
(See also section 4.2.1 Volume control)

12. Damages that require service

Unplug this amplifier from the mains supply and refer to your dealer/distributor or other authorised repair workshop if any of the following situations occur:

- if liquid has been spilled or objects have fallen into the amplifier
- if the amplifier does not operate normally as described in the user manual, operate the controls only as described in the user manual
- if the amplifier has been dropped or damaged in any other way
- when the amplifier exhibits a distinct change from its normal function or performance

13. Servicing

Do not attempt to service this amplifier yourself. As opening or removing covers may expose you to dangerous voltage or other hazards, the amplifier may only be opened by qualified personnel. Please refer to your dealer/distributor.

14. Servicing and Replacement Parts

All service and repair work must be carried out by a **CAMCO** authorised dealer. When replacement parts are required, please ensure that the dealer/distributor only uses replacement parts specified by the manufacturer. The use of unauthorized replacement parts may result in injury and/or damage through fire or electric shock or other electricity-related hazards.

15. Safety Check

Upon completion of any service or repairs to this product, ask the dealer/distributor to perform safety checks to determine that the amplifier is in proper operating condition.

Recommendations on how to carry out the safety test can be found in DIN VDE 0701-1 "Maintenance, Modification and Test of Electronic Appliances".



EC Declaration of Conformity in accordance to EC Directives:

electro-magnetic compatibility (Council Directive 2004/108/EC);
low-voltage electrical equipment (Council Directive 73/23/EEC)

Manufacturers Name:

CAMCO Produktions- und Vertriebs-GmbH
für Beschallungs- und Beleuchtungsanlagen

Manufacturers Address:

Fischpicke 5, D-57482 Wenden, Germany

Declares that the product with the model name:

CAMCO Power amplifier **D-POWER 2**, **D-POWER 3** and **D-POWER 4**

Conforms to the following standards:

- EN60065 Safety
- EN55103-1 Emission
- EN55103-2 Immunity

The operating conditions and application environments presupposed in the information for use (user manual) are to be kept accordingly.

Wenden, 17.04.2009

Joachim Stöcker



P.2	IMPORTANT SAFETY INSTRUCTIONS	4.2	Indicators	P.30	8 WARRANTY INFORMATION
P.3	EXPLANATION OF SYMBOLS / SAFETY	4.2.1	On LEDs	8.1	Summary Of Warranty
P.5	EC DECLARATION OF CONFORMITY	4.2.2	Signal / Protect LEDs	8.2	Items Excluded From This Warranty
P.6	CONTENTS	P.18	4.2.3 I-Out LEDs	8.3	What CAMCO Will Do
P.7	1 WELCOME	4.2.4	Clip LEDs	8.4	How To Obtain Warranty Service
1.1	Welcome to CAMCO	4.2.5	Mode Indicators	8.5	CAMCO's Product Improvement
1.2	Unpacking	P.19	4.3 Power Amp Protection Systems	P.31	9 SERVICE INFORMATION
P.8	1.3 The Amplifier	4.3.1	Clip Limiter	P.32	10 MAINTENANCE INFORMATION
P.9	2 FACILITIES	4.3.2	SOA Protection	11	DECOMMISSIONING
2.1	D-POWER – The Front	4.3.3	DC Protection	P.32	COMPANY INFORMATION
2.2	D-POWER – The Rear	4.3.4	DC Servo		
P.10	2.3 Factory Settings	4.3.5	Over Current Protection		
P.11	3 INSTALLATION	4.3.6	Thermal Protection		
3.1	Mains Supply	P.20	4.4 Mains Protections		
3.2	On/Off Switch	4.4.1	Inrush Current Limitation		
P.12	3.3 Mounting	4.4.2	Mains Over Voltage Detection		
3.4	Cooling	4.4.3	Mains Failure Detection		
3.5	Ground Lift	4.4.4	Fuse Protection		
P.13	3.6 Mode Selector	4.5	Main SMPS Protections		
3.7	Wiring	4.5.1	Over Current Protection		
3.7.1	XLR Connection	4.6	Fans		
P.14	3.7.2 Stereo Operation	P.21	4.7 Filter Cleaning		
3.7.3	Parallel-Mono Operation	P.22	4.8 Volume Control Security Cover (Accessory optional)		
3.7.4	Mono-Bridge Operation	P.23	5 TROUBLESHOOTING		
P.15	3.7.5 SPEAKON Connection	5.1	Problem: No Sound		
P.16	4 OPERATION	5.2	Problem: No Channel Separation		
4.1	Controls	5.3	Problem: Distorted Sound		
4.1.1	Volume Control	5.4	Problem: Hiss		
4.1.2	Gain Selector	5.5	Problem: Squeals and Feedback		
4.1.3	Gain and Input Sensitivity	P.24	6 SPECIFICATION		
4.1.4	Limiter Switch	P.26	7 TYPICAL PERFORMANCE DIAGRAMS		
P.17	4.1.5 High Pass Filter				



1.1 Welcome to CAMCO

Established in 1983, **CAMCO** has gained worldwide experience with professional sound reinforcement technology. Within the audio market **CAMCO** specialises in the production and marketing of high quality power amplifiers and sound systems for use both on tour and in fixed installations.

The success of the **LA, DL, DX, VORTEX** and **TECTON** series of power amps has made the **CAMCO** name synonymous with professional quality, high performance and utterly reliable power amps.

CAMCO's commitment to research and development, seen not just in the area of materials and technology but also most importantly in its highly skilled and motivated workforce, is one of the keys to its ongoing success.

Welcome to the new world of professional power amplifiers –

WELCOME TO CAMCO!

1.2 Unpacking

Please unpack and inspect your new amplifier for any damage that may have occurred during transit. If damage is found, notify the transportation company immediately. Only you the consignee may initiate a claim for shipping damage. **CAMCO** will be happy to cooperate fully as needed. Please save the shipping carton as evidence of damage for the shipper's inspection.

Even if the amplifier has arrived in perfect condition, save all packing materials so you will have them if you ever need to transport the unit.

NEVER SHIP THE AMPLIFIER WITHOUT THE ORIGINAL PACKING MATERIALS.

When shipping the **D-POWER** amplifier, always use the original shipping carton and packing materials. For maximum protection, repack the unit as it was originally packed at the factory.

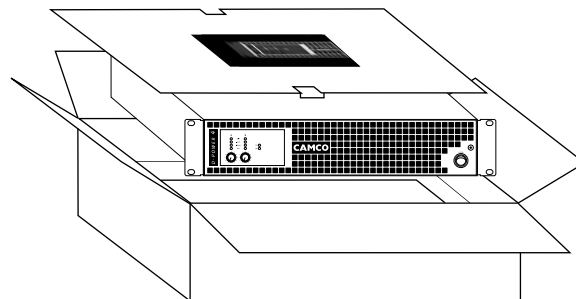



1.3 The Amplifier

The **D-POWER** is a Class-H power amplifier with a power output of:

- D-POWER 2** 1200 W per channel @ 4 Ω
2400 W in Mono-Bridge @ 8 Ω
2400 W in Parallel-Mono @ 2 Ω
- D-POWER 3** 1600 W per channel @ 4 Ω
3200 W in Mono-Bridge @ 8 Ω
3200 W in Parallel-Mono @ 2 Ω
- D-POWER 4** 1900 W per channel @ 4 Ω
3800 W in Mono-Bridge @ 8 Ω
3800 W in Parallel-Mono @ 2 Ω

D-POWER amplifiers are fitted with Switched Mode Power Supplies (SMPS), which significantly reduces the weight and size (only 2U) of the amplifier. Using SMPS, the 2 symmetrical supply voltages of the power amplifier are more stable than the power supplies used in conventional amplifiers.

The **D-POWER** has been designed as an intelligent and powerful product for performing specialised tasks within a complex audio system. Users can adapt the power amp to meet their specific audio requirements before use. Controls mounted on the front and the rear of the **D-POWER** allow access to the functionality.

Since some of the externally mounted controls have multiple functions, it is important that users should familiarise themselves thoroughly with the entire range of controls.

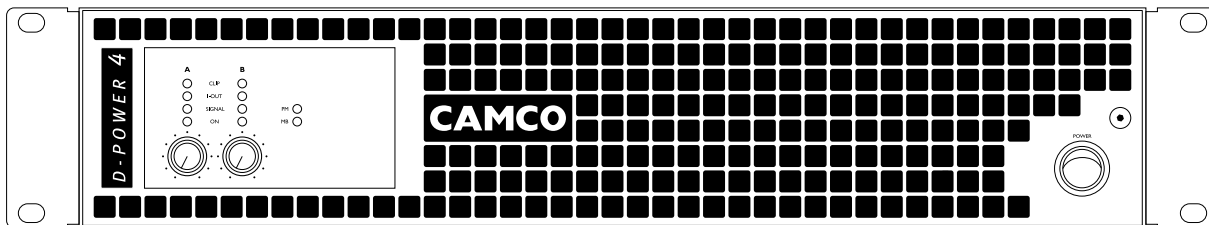

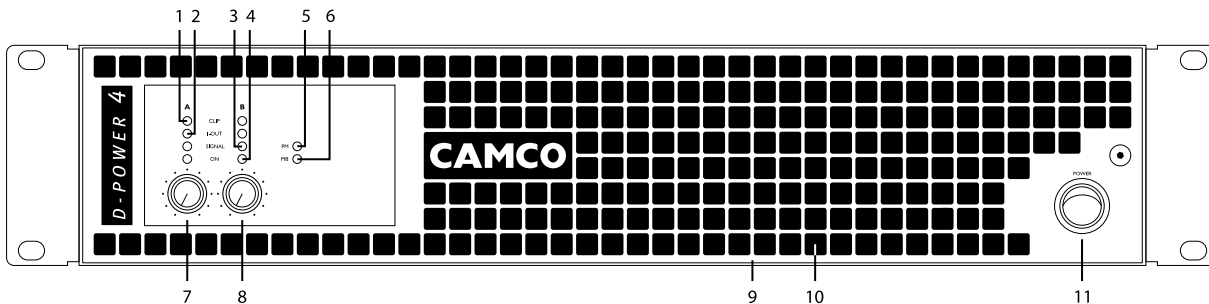

2.1 D-POWER – The Front

- 1 Clip LEDs
- 2 I-Out LEDs
- 3 Signal LEDs
- 4 On LEDs
- 5 Parallel-Mono Mode LED
- 6 Mono-Bridge Mode LED
- 7 Volume Control Channel A
- 8 Volume Control Channel B
- 9 Removable Air Filter
- 10 Cooling Air Inlet Vents
- 11 On/Off Switch

2.2 D-POWER – The Rear

- 12 Input Ground Lift Switch
- 13 High Pass Filter B
- 14 Mode Selector
- 15 Gain Selector
- 16 High Pass Filter A
- 17 Clip Limiter Switch
- 18 Rating Plate
- 19 AC Power Cable
- 20 SPEAKON Output A
- 21 SPEAKON Output B
- 22 Cooling Air Outlet Vents
- 23 XLR - Line Link A
- 24 XLR - Line Link B
- 25 XLR - Line Input A
- 26 XLR - Line Input B

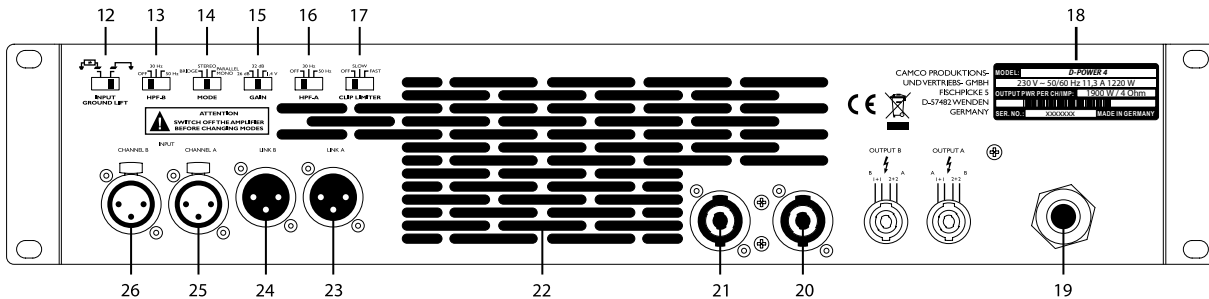

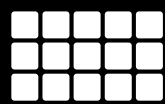

2.3 Factory Settings

D-POWER amplifiers are delivered with the following factory settings

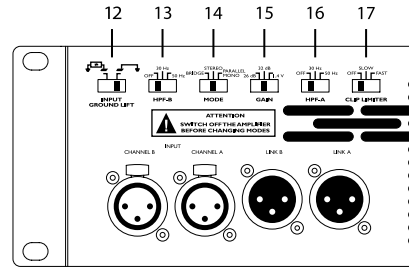
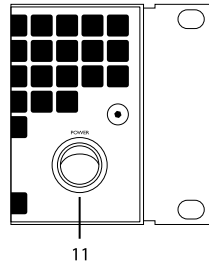
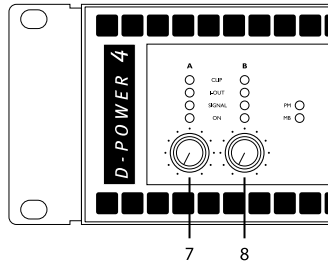

Front panel:

7	Volume Control Channel A	The volume is set to minimum.
8	Volume Control Channel B	The volume is set to minimum.
11	On/Off Switch	The amplifier is switched off.

Rear panel:

12	Input Ground Left	Grounded
13	High Pass Filter B	Off
14	Mode Selector	Stereo
15	Gain Selector	32 dB
16	High Pass Filter A	Off
17	Clip Limiter	Off

Make sure that the switches are set to the configuration needed for each particular application.

For more detailed information, see sections 3.5, 3.6, 3.7 and 4.1.

3.1 Mains Supply

When mounting or connecting the amp always disconnect it from mains. Only connect the D-POWER amplifier to an appropriate AC circuit and outlet, according to the requirements indicated in the second line on the rating plate.

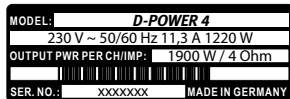
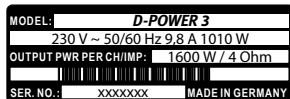
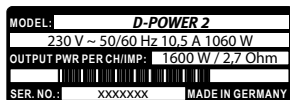

Exemplary rating plates for a mains supply of 230 V ~ 50/60 Hz.

Power supply data:

	Voltage	Mains Frequency	Current	Power Consumption
D-POWER 2	120 V	50/60 Hz	21 A	1060 W
D-POWER 2	220 V	60 Hz	10,5 A	1060 W
D-POWER 2	230 V	50/60 Hz	10,5 A	1060 W
D-POWER 3	120 V	50/60 Hz	19,6 A	1010 W
D-POWER 3	220 V	60 Hz	9,8 A	1010 W
D-POWER 3	230 V	50/60 Hz	9,8 A	1010 W
D-POWER 4	120 V	50/60 Hz	22,6 A	1220 W
D-POWER 4	220 V	60 Hz	11,3 A	1220W
D-POWER 4	230 V	50/60 Hz	11,3 A	1220 W

3.2 On/Off Switch

The On/Off Switch is a rocker-type switch. It is located on the right side of the front panel. To turn the amplifier on, press on the upper part of the switch. During power up the Clip and Signal LEDs from both channels will light up in red for a few seconds. To turn the amplifier off, press on the lower part of the switch.



Amplifier is switched on

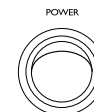

Amplifier is switched off

NOTE: This switch does NOT disconnect the amplifier from mains. Make sure the mains power socket or an alternative disconnect device is near by and easily accessible.

The switch initiates start-up by activating the inrush current limiter. As soon as the power amplifier is connected to the mains power supply, a voltage is supplied to both the line-filter and the fused input of the controllable rectifier. Disconnecting the amplifier from the main power supply can only be achieved by physically separating the amplifier from the mains by pulling the mains plug. The mains plug therefore has to be freely accessible. Disconnect the mains plug from the mains during a lightning storm or when the amplifier remains unused or unsupervised for a prolonged period of time. Alternatively, you can disconnect the amplifier via an external all-pole disconnection from the mains. If a power cut occurs while the amplifier is switched on, it will restart automatically once the power supply has been restored. All amplifier settings prior to the loss of power will be maintained.

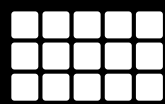

3.3 Mounting

Use four screws and washers when mounting the amplifier to the front rack rails. For mobile use, the amplifier should also be secured using the 19" mounting elements on the rear panel.

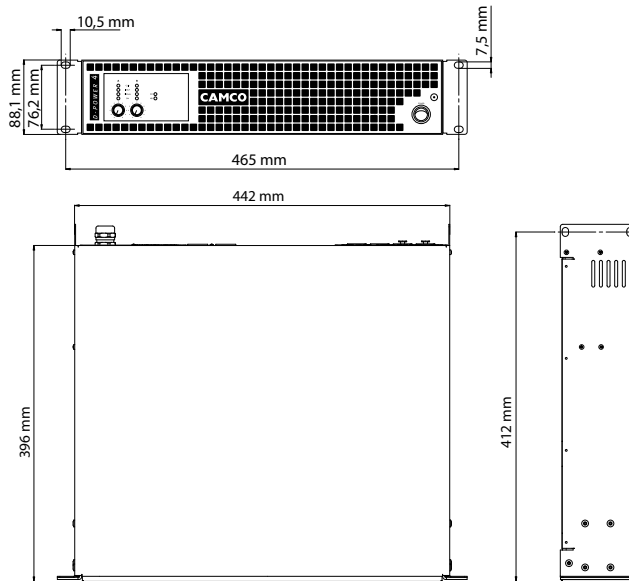

3.4 Cooling

Under normal operation of the power amp, overheating should never be a problem. The air is taken in from the front and out through the back. It is essential that while the amplifier is running the air is able to circulate around it freely. The efficiency of the cooling will depend on the immediate environment (e.g. an enclosed rack, direct sunlight). If the amp is installed in a case, the open area at the back of the case must be at least 140 cm². This area should be in line with the amplifier.

If this can not be achieved a forced ventilation system has to be used.

3.5 Ground Lift

The input signal ground (pin 1 for all 4 XLRs) is connected to the ground of the mains supply. In order to avoid ground loops, this connection can be separated via a resistor. The ground potential of the power amp and the ground of the loudspeaker always remain connected to the ground of the mains supply regardless of the setting of this switch.

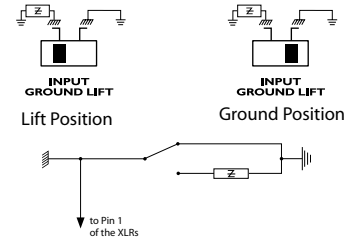

Removing or taping the mains connector ground is illegal and dangerous.



**DO NOT REMOVE MAINS CONNECTOR GROUND
IT IS ILLEGAL AND DANGEROUS**

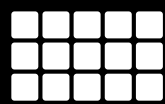

3.6 Mode Selector

The switch on the rear panel changes the operating mode.

WARNING!

Always turn off the amplifier before making changes on the Mode Selector.

When the amplifier is switched on again, the selected mode will operate.

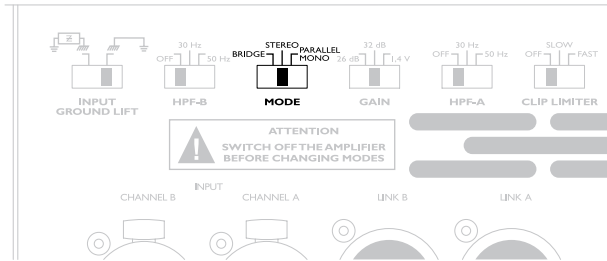

!
**ALWAYS SWITCH OFF THE AMPLIFIER
BEFORE CHANGING MODES**

3.7 Wiring

3.7.1 XLR Connection

XLR: Pin 1 = Ground (or lifted via 15 Ω resistor) (See 3.5 Ground Lift)

Pin 2 = Hot (inphase)

Pin 3 = Cold (out of phase)

Always use symmetrical (balanced) shielded cable to connect the amplifier.

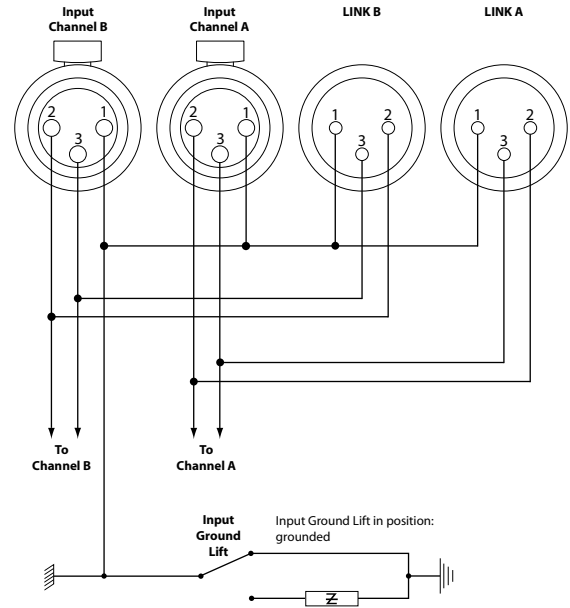



3.7.2 Stereo Operation, Two Channel Operation

Two fully independent amplifier channels (normal operating mode).

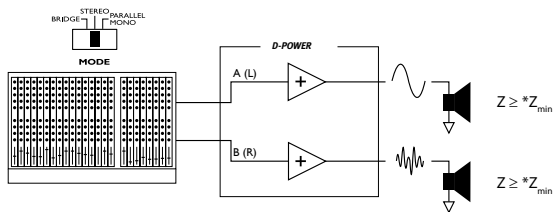

3.7.3 Parallel-Mono Operation

Parallel operation of the two channels together.

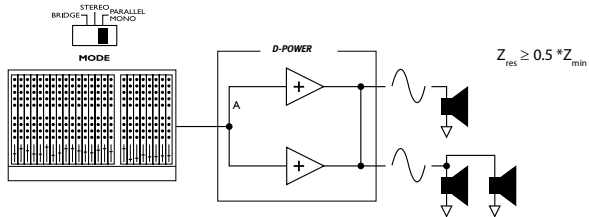

The output terminals of the two channels are configured in parallel using an internal relay. The (single) load is connected either to the output of channel A or to that of channel B (as if in stereo). While the total output of the amplifier remains the same and the output voltage level is also the same as in stereo operation, the minimum impedance that can be connected is reduced by half due to the fact that current capability is doubled. Only channel A-Input is active. The channel B-Input is inactive – turn the volume of channel B down to zero.

This mode is useful when, for example, three identical loudspeakers are to be operated with the same power.

3.7.4 Mono-Bridge Operation

One-channel mono bridged operation.

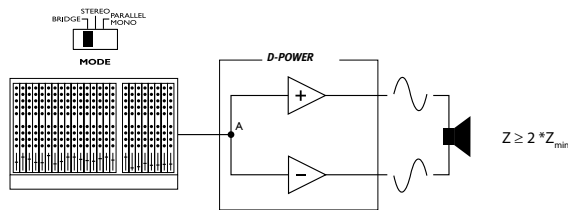

The second amplifier channel processes the same input signal, but with reversed phase. The (single) load is connected between the two positive channel outputs using a suitable connected SPEAKON connector. While the total output of the amplifier remains the same, both the available output voltage and the minimum impedance that can be connected are doubled, as compared with stereo operation. Only channel A-Input is active. A signal feeding channel B will have no effect on the output. Turn the volume of channel B down to zero.

WARNING !

In Mono-Bridge mode RMS output voltages are as high as 230 V. Wiring to the speaker loads must conform to NEC Class 3 safety standards or its equivalent that meets all national and local electric codes.

All customer specific cables may only be manufactured by qualified suppliers/personnel. All cabling or rewiring work must be carried out by qualified personnel.

* $Z_{min} = 4 \Omega$ for **D-POWER 2, 3 and 4**

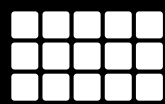

3.7.5 SPEAKON Connection

Both SPEAKON connectors are connected to channel A and channel B outputs. The pin configuration of the SPEAKON connectors is as follows:

SPEAKON right: (View at the back)	Pin 1+	Channel A	signal
	Pin 1-	Channel A	ground
	Pin 2+	Channel B	signal
	Pin 2-	Channel B	ground

SPEAKON left: (View at the back)	Pin 1+	Channel B	signal
	Pin 1-	Channel B	ground
	Pin 2+	Channel A	signal
	Pin 2-	Channel A	ground

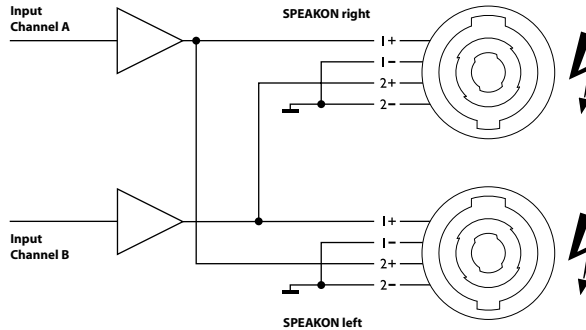

WARNING!

SPEAKON connectors marked with the lightning flash indicate high voltages that are potentially life threatening.

Wiring to these terminals requires installation by an instructed person or the use of ready-made leads or cords.

Custom wiring should only be made by qualified personnel.

To prevent electric shock, do not operate the amplifier with any of the conductor portion of the speaker wire exposed.

NOTE:

For reasons of safety and performance, use only high-quality fully insulated speaker cables of stranded copper wire. Use the largest wire size that is economically and physically practical, and make sure the cables are no longer than necessary.

IMPORTANT:

When connecting speaker cabinets in parallel, always use all the contacts in both SPEAKON connectors. If not, this may cause permanent damage to the connectors and considerably reduce performance.



4.1 Controls

4.1.1 Volume Control

A volume control with 41 notched settings controls the audio signal. These settings have been selected to correspond to human hearing characteristics (logarithmically) and therefore guarantee an optimal range of settings for practical applications. Each channel can be set individually except when operating in mono modes whereby only channel A is active.

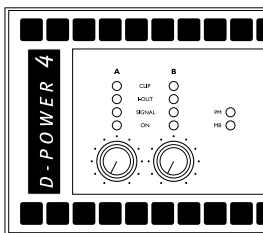

Set the volume to zero before turning on the amplifier to prevent the occurrence of sudden high volume levels which may cause damage to your hearing and/or the speakers.

4.1.2 Gain Selector

A switch on the rear of the **D-POWER** allows the maximum amplification attainable to be set directly in the input stage.

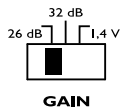

The **D-POWER** amplifier has a 26 dB and 32 dB voltage gain setting along with a 1,4 V sensitivity setting.

4.1.3 Gain and Input Sensitivity

The table shows input sensitivity per channel for a given gain and load. It also shows the gain for the 1,4 V input sensitivity.

Model		26 dB	32 dB	1,4 V
D-POWER 2	1200 W @ 4 Ω	3,47 V	1,74 V	34,56 dB
	700 W @ 8 Ω	3,75 V	1,88 V	
D-POWER 3	1600 W @ 4 Ω	4,01 V	2,01 V	35,72 dB
	915 W @ 8 Ω	4,29 V	2,15 V	
D-POWER 4	1900 W @ 4 Ω	4,37 V	2,19 V	36,52 dB
	1100 W @ 8 Ω	4,70 V	2,36 V	

4.1.4 Limiter Switch

This switch is located at the rear of **D-POWER**. It allows you to set the mode of the limiter. There are three modes. (See 4.3.1 Clip Limiter)

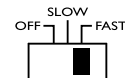

CLIP LIMITER

Right position:
Clip Limiter: Fast
Fast attack time

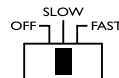

CLIP LIMITER

Middle position:
Clip Limiter: Slow
Slow attack time

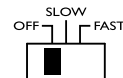

CLIP LIMITER

Left position:
Clip Limiter: Off
Limiter disabled

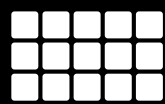

4.1.5 High Pass Filter (Channel A as example)

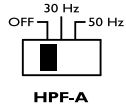

HPF-A
Left position:
HPF: Off

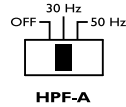

HPF-A
Middle position:
HPF: 30 Hz

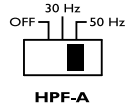

HPF-A
Right position:
HPF: 50 Hz

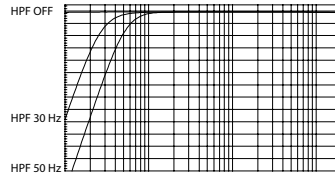

Low frequency response curves

4.2 Indicators 4.2.1 On LEDs

Under normal operation, after the amp has started, the green power LEDs are permanently lit.

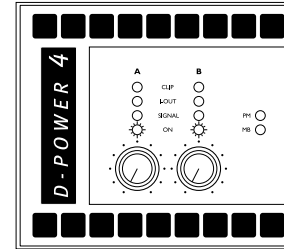

4.2.2 Signal / Protect LEDs (multifunctional)

The green Signal LEDs are illuminated when the voltage level at the output reaches approx. 4 V; this corresponds to a power of approx. 4 W into a 4 Ohm load. The channel signal LEDs are illuminated red when the amplifier is in Protect Mode (Mute), for example because of persistent DC-voltage at the outputs or overheating.

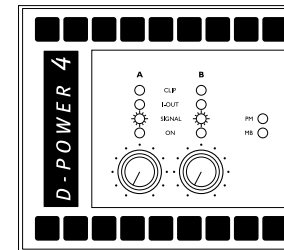



4.2.3 I-Out LEDs

The brightness is proportional to the output current in the corresponding channel.

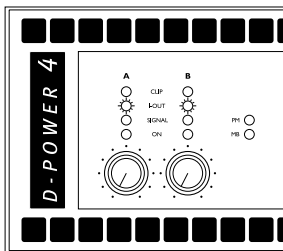

4.2.4 Clip LEDs

This LED indicates an overloading of the amplifier when the power output level is to high.

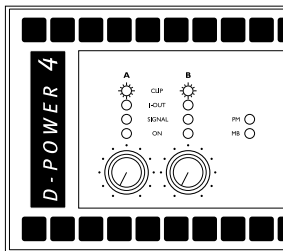

4.2.5 Mode Indicators

On the front panel there are two yellow LEDs to indicate the mode that is set. In stereo mode (2-channel) none of them will be lit. In Parallel-Mono the (PM) LED will be lit and in Mono-Bridge, the (MB) LED will be lit.

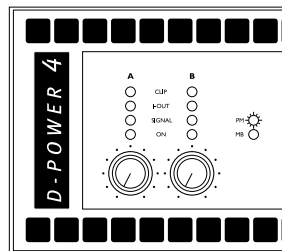

Amplifier in Parallel-Mono mode

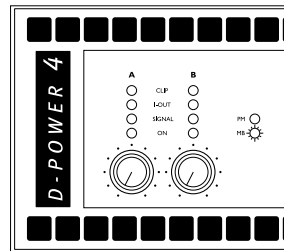

Amplifier in Mono-Bridge mode



4.3 Power Amp Protection Systems

4.3.1 Clip Limiter

If the power amp is overdriven, the clip detection triggers the Attack-Release-Circuit (ARC). The ARC delivers the control voltage for the gain reduction. Two different attack modes (fast and slow) can be selected with the Clip Limiter switch (see 4.1.4 Limiter Switch).

4.3.2 SOA Protection

Whenever the power transistors leave their Safe Operation Area (SOA), the SOA-protection in stereo mode switches back the current rail of the respective channel. In mono modes the rails of both channels are switched back.

4.3.3 DC Protection

Each output of the power amp is constantly monitored for persistent DC voltage levels. If the 3V thresholds are exceeded at any of the outputs, the corresponding channel will be muted. If DC was only detected for a short moment, the amplifier will release mute and work as normal. If DC is detected for longer periods or repeatedly if this happens, the amplifier will switch to standby mode.

Switch off the amplifier, wait until the power LED stops flashing and switch the amplifier on again.

4.3.4 DC Servo

To prevent DC Offset at the speaker output the **D-POWER** is fitted with a DC Servo.

4.3.5 Over Current Protection

Over current is permanently controlled in the output stage. There are two limiting levels of over current depending on output voltage. These limits will be set automatically. This improves reliability without degrading sound quality when driving complex loads.

4.3.6 Thermal Protection

There are several sensors inside the amplifier in order to ascertain temperature data. If a temperature of more than 85 °C is detected at the heat sinks, the input signal on that channel is reduced. If the temperature exceeds 100 °C, the main SMPS will be switched off.



4.4 Mains Protections

4.4.1 Inrush Current Limitation

Within 2 seconds of the amplifier being switched on, the inrush current limiter will increase mains current from nearly zero to nominal value. This value depends on program material, output level and speaker loads.

4.4.2 Mains Over Voltage Detection

Mains over voltage detection is always operative. When the mains voltage exceeds approx. 263 V (230 V operation) or 134 V (120 V operation), the amplifier will be switched off. The system will try to restart in intervals and will return with a soft start when the regular mains voltage returns.

4.4.3 Mains Failure Detection

Mains failure detection is always operative. When the mains supply is interrupted for about 2 mains cycles, the amplifier will be switched off. When the mains voltage returns to a normal value, a soft start occurs.

4.4.4 Fuse Protection

The average mains current can peak temporarily, depending on the load impedance and type of signal, at values significant higher than the nominal value allowed by the fuse protection.

Continuous monitoring of the fuse protection status allows the conditions that would trigger the fuse protection to be predicted. In order to avoid shut-down of the amplifier due to current overload, the amplitude of the input signals will be limited and by hard overloads the amp will be muted for the time.

4.5 Main SMPS Protections

4.5.1 Over Current Protection

Main SMPS (Switched Mode Power Supply) transformer current is continuously monitored. If over current occurs, the main SMPS immediately stops working. Should there be an internal failure, this feature prevents other parts being damaged.

4.6 Fans

The fans mounted in the **D-POWER** operate permanently, but as long as the temperature remains below 40 °C they run at their slowest speed and can hardly be heard. The highest detected temperature from either channel controls the speed of the fans: above 40 °C the speed is increased until it reaches its maximum value.



4.7 Filter Cleaning

The air intake on the front of your **D-POWER** Amplifier is fitted with a removable filter system. If the filter becomes clogged, the unit will not cool as efficiently as it should and may result in reduced output levels.

WARNING: Disconnect the amplifier from the mains before removing the front frame.

WARNING: Turn off the amplifier before removing the front frame.

To clean or replace the filter just slightly unscrew the fixing screw (3) without completely removing it from the front frame (it is held back by a small plastic spacer on the back side of the frame to avoid loosening the screw). Then shift the front frame slightly to the right. Then you should be able to remove the frame from the amplifier completely (pull gently to avoid any bending of the front frame).

D-POWER Filter Assembly

- 1 Foam Filter
- 2 Front Frame
- 3 Screw

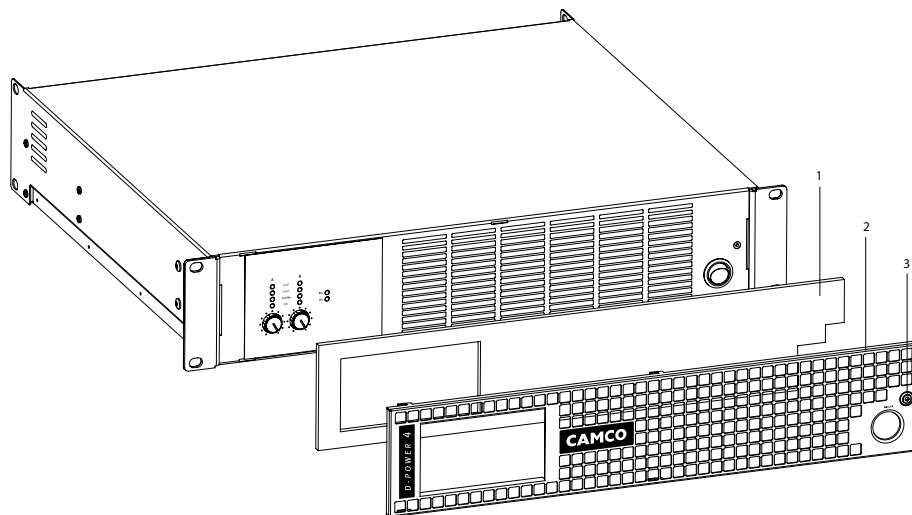

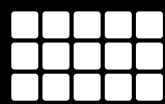

4.8 Volume Control Security Cover (Accessory optional)

It is possible to install a solid protection over the volume controls to prevent intentional or unintentional changes of the amplifier volume settings.

The **GAIN-POT-COV** package contains:

- Volume Control Security Cover (1)
- Two fixing screws (2)
- Jig (3)
- Tech Note with informations about mounting the Volume Control Security Cover (not illustrated))

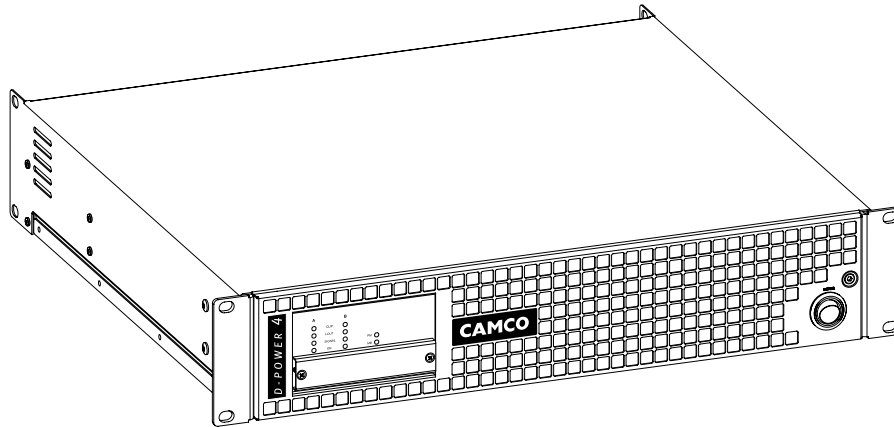
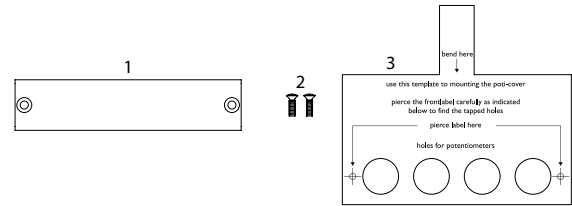

Please contact CAMCO or your dealer/distributor for more details.



5.1 Problem: No Sound

Indication:

Signal LEDs not lit
Clip LEDs not lit

- Check AC plug.
- Confirm that AC outlet works by plugging in another device.

Indication:

Output Current LEDs are lit
Signal LEDs not lit

- Make sure the signal source is operating and try another cable.
- Check position of volume pots.

Indication:

Output Current LEDs are lit
Signal LEDs responding to signal level

- Check the speaker wiring for breaks.
- Try another speaker and cable.

Indication:

Signal LEDs show red (Protect Mode)

- Overheating will cause protective muting. Check for proper ventilation.
- If the fans aren't running the amplifier requires servicing.

5.2 Problem: No Channel Separation

- Check the mode indicators on the front panel and make sure the mode selector on the rear panel is in the stereo-position.
- Make sure other equipment in the signal path such as mixers and preamps are set for stereo, not mono.

5.3 Problem: Distorted Sound

Indication:

Output Current LEDs are lit
Signal LEDs responding to signal level
Clip LEDs not lit

- A faulty speaker or a loose connection could cause this. Check the wiring and try another speaker.
- The signal source might be clipping. Keep the **D-POWER** volume pots at least halfway up so that the source does not have to be overdriven.
- Keep the **D-POWER** volume pots at least halfway up and try changing input sensitivity from 1,4 V to 32 dB or 26 dB with the gain selector on the rear.

5.4 Problem: Hiss

- Unplug the amplifier input to confirm that the hiss is coming from the source or from a device upstream. Erratic or popping noises indicate an electronic fault in the offending unit.
- To keep the noise floor low, operate the primary signal source at full level, without clipping.
- Avoid boosting the signal further between the source and the amplifier.

5.5 Problem: Squeals and Feedback

- Microphone feedback should be eliminated with mixer controls. If noise continues to build up with no microphone gain, there is a serious fault in the signal processors or cables. Working in succession from the signal source towards the amplifier and check each device in the signal path by reducing its gain or by unplugging it.



	D-POWER 2		D-POWER 3		D-POWER 4		
Output Power							
1 kHz, THD ≤ 1 %, in mono-bridge mode	1 x 2400 W @ 8 Ω 1 x 1400 W @ 16 Ω		1 x 3200 W @ 8 Ω 1 x 1800 W @ 16 Ω		1 x 3800 W @ 8 Ω 1 x 2200 W @ 16 Ω		
1 kHz, THD ≤ 1 %, both channels driven <small>Duration limited by fuse / thermal protection for RL < 8 Ω in stereo mode or RL < 16 Ω in mono-bridge mode.</small>	2 x 1600 W @ 2,7 Ω 2 x 1200 W @ 4 Ω 2 x 700 W @ 8 Ω		2 x 1600 W @ 4 Ω 2 x 915 W @ 8 Ω		2 x 1900 W @ 4 Ω 2 x 1100 W @ 8 Ω		
1 kHz, THD < 0,1 %, both channels driven	2 x 1135 W @ 4 Ω 2 x 655 W @ 8 Ω		2 x 1500 W @ 4 Ω 2 x 860 W @ 8 Ω		2 x 1800 W @ 4 Ω 2 x 1070 W @ 8 Ω		
Circuitry	Bipolar, Class H 2-step high efficiency circuit		Bipolar, Class H 2-step high efficiency circuit		Bipolar, Class H 2-step high efficiency circuit		
Signal to Noise-Ratio							
20 Hz - 20 kHz, 8 Ω load, unweighted	>110 dB		>111 dB		>112 dB		
A-weighted	>114 dB		>115 dB		>116 dB		
Power Consumption @ 230 V (both channels driven)							
	Typical¹⁾	Max²⁾		Typical¹⁾	Max²⁾	Typical¹⁾	Max²⁾
Idle	1,2 A 50 W		Idle	1,3 A 55 W		Idle	1,4 A 60 W
16 Ω	3,9 A 250 W	9,9 A 1000 W	16 Ω	3,9 A 330 W	12,2 A 1280 W	16 Ω	4,8 A 410 W 14,8 A 1600 W
8 Ω	5,2 A 460 W	16,5 A 1840 W	8 Ω	6,2 A 580 W	21 A 2410 W	8 Ω	7,3 A 700 W 25 A 3000 W
4 Ω	7,9 A 790 W	27 A 3230 W	4 Ω	9,8 A 1010 W	34 A 4300 W	4 Ω	11,3 A 1220 W 40 A 5230 W
2,7 Ω	10,5 A 1060 W	36 A 4600 W					

Multiply currents by 2 for 120 V

¹⁾ 1/8 of max Output Power with pink noise to represent typical music signal

²⁾ max. rated Output Power (see above)



Frequency Response	20 Hz - 20 kHz \pm 0,15 dB 8 Ω load, 10 dB below rated power
Input Impedance	14 k Ω balanced
Voltage Gain	selectable: 26 dB, 32 dB, or 1,4 V input sensitivity
Protection Circuits	inrush-current limitation, temperature monitoring of heat-sinks, output DC protection, power transistor SOA protection, output over current protection, mains fuses protection
Limiter	switchable clip limiter
Fans	two temperature dependent speed-controlled axial fans
Ground Lift	input ground lift switch on back panel
Indicators	LEDs for Power-ON, Mode, Signal, Clip, Output Current and faults (e. g. DC)
Input Connectors	3-pin XLR, male and female per channel, pin 2 = inphase (hot)
Output Connectors	one 4-pole SPEAKON connector for each output channel (bi-amping possible)
Modes of Operation	Stereo, Mono-Bridge and Parallel-Mono
Options	Volume Control Safety Cover
THD+N (typical) 20 Hz - 10 kHz, 8 Ω load, 10 dB below rated power	< 0,01 %
SMPTE (typical) 8 Ω load, 10 dB below rated power	< 0,01 %
Damping Factor 8 Ω load, 1 kHz and below	> 400
Dimensions (WxHxD)	483 x 88,1 x 421 mm (19",2U)
Net Weight	9,6 kg
Shipping Dimensions (WxHxD)	615 x 135 x 540 mm (0,045 m ³)
Shipping Weight	11,2 kg

Subject to technical alterations without prior notice

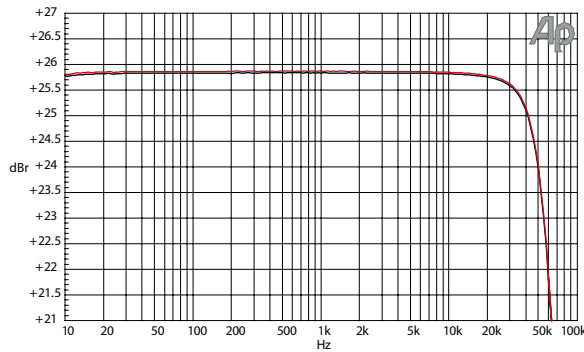
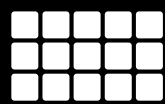

Figure 8.1
Gain vs. frequency (Ch1, Ch2)
(Measurements of a typical performance)

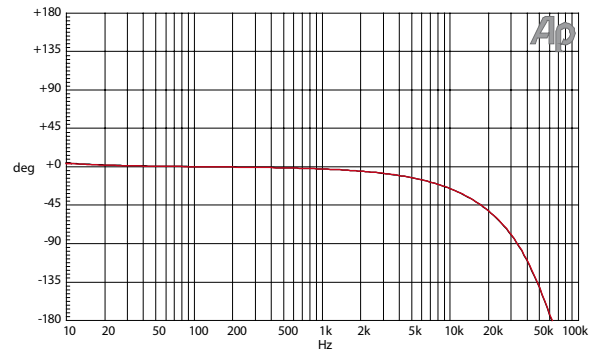

Figure 8.3
Phase vs. frequency (Ch1, Ch2)
(Measurements of a typical performance)

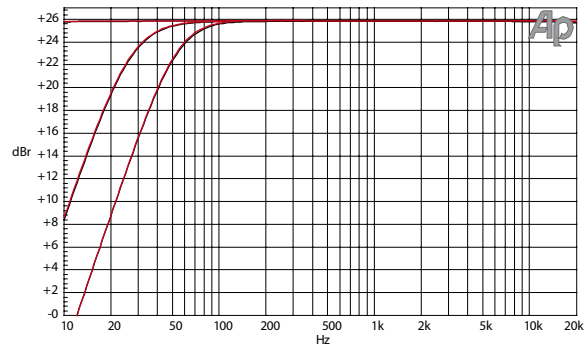

Figure 8.2
Gain vs. frequency / Different positions of HPF-Switch (Ch1, Ch2)
(Measurements of a typical performance)

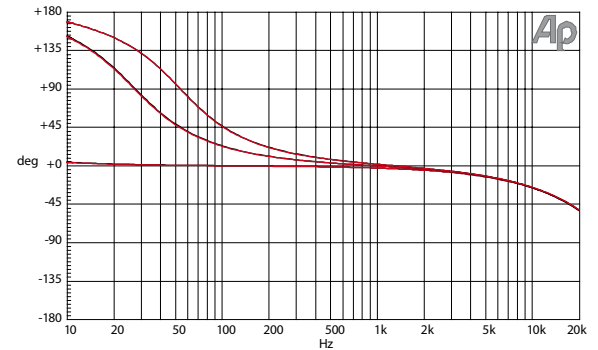

Figure 8.4
Phase vs. frequency / Different positions of HPF-Switch (Ch1, Ch2)
(Measurements of a typical performance)

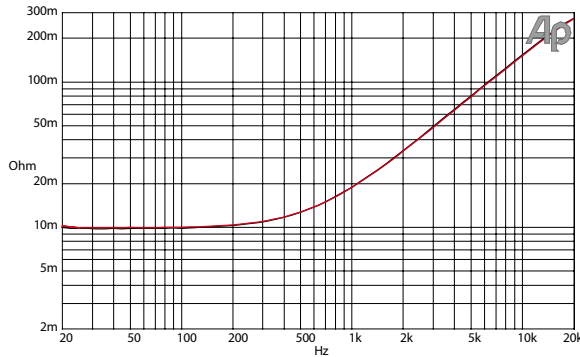
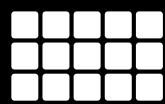

Figure 8.5 Output impedance vs. frequency
@ 1 Amp RMS injected current (Ch1, Ch2) equivalent 11 mΩ + 2,1 μH
(Measurements of a typical performance of **D-POWER 3**)

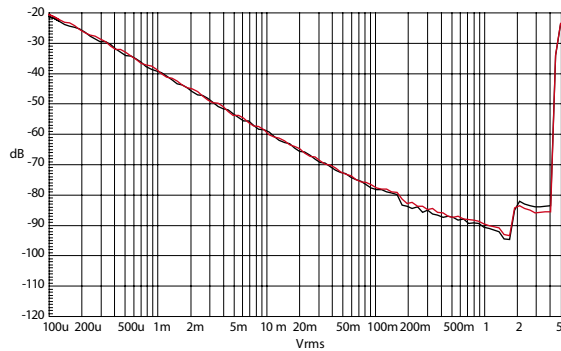

Figure 8.6
THD+N @ 1 kHz, 8 Ω load vs. input voltage (Ch1, Ch2)
(Measurements of a typical performance of **D-POWER 3**)

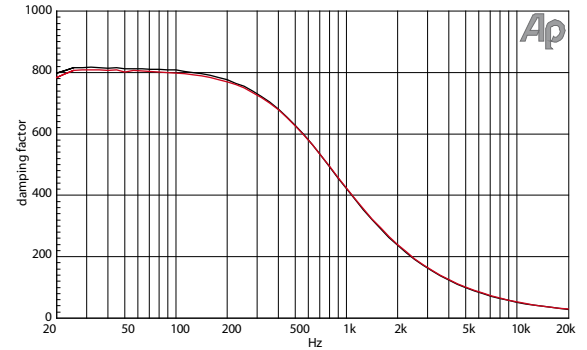

Figure 8.7 Damping factor into 8 Ω (Ch1, Ch2)
equation: damping factor = loaded impedance / amplifier output impedance
(Measurements of a typical performance of **D-POWER 3**)

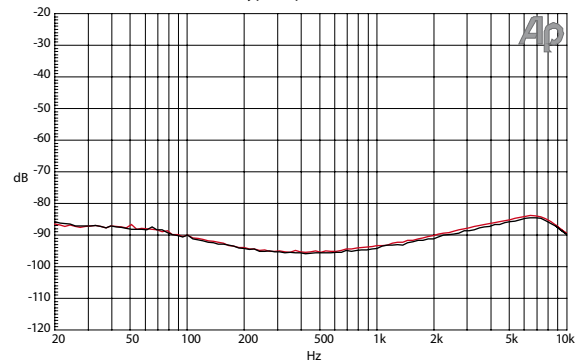

Figure 8.8
THD+N vs. frequency (BW 22 kHz), 10 dB below clip, 8 Ω (Ch1, Ch2)
(Measurements of a typical performance of **D-POWER 3**)

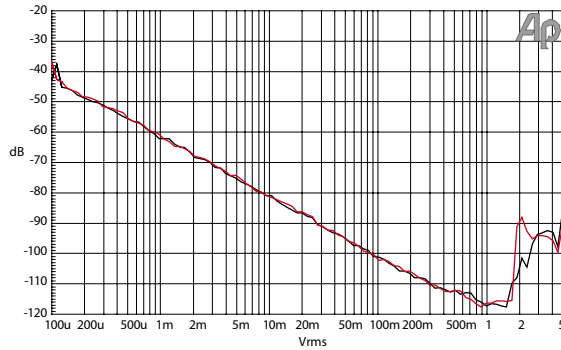
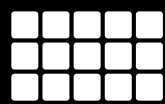

Figure 8.9

CCIF difference frequency method (10,5 kHz and 11,5 kHz) vs. input level @ 8 Ω (Ch1, Ch2) (Measurements of a typical performance of **D-POWER 3**)

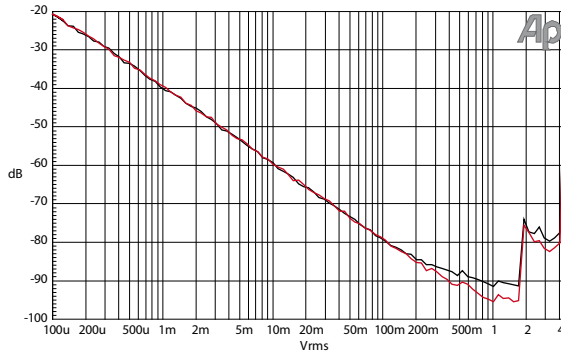

Figure 8.10

SMPTE intermodulation distortion (60 Hz and 7 kHz) @ 8 Ω vs. input level (Ch1, Ch2) (Measurements of a typical performance of **D-POWER 3**)

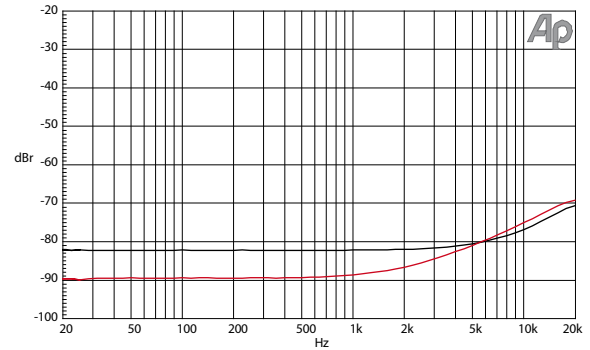

Figure 8.11

Common mode rejection ratio (Ch1, Ch2) (Measurements of a typical performance of **D-POWER 3**)

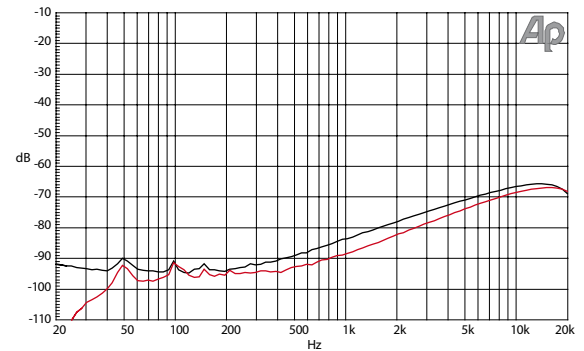

Figure 8.12

Channel separation vs. frequency @ 10 W / 8 Ω (Ch1 => Ch2, Ch2 => Ch1) (Measurements of a typical performance of **D-POWER 3**)

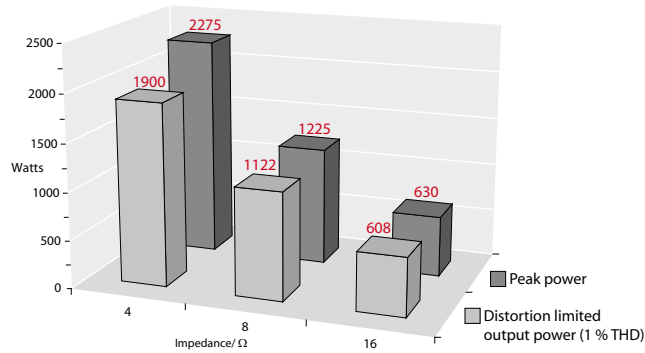
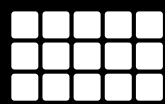

Figure 8.13

D-POWER 4 (Measurements of a typical performance)

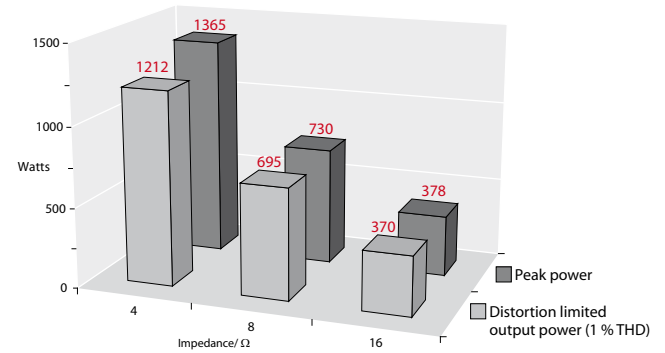

Figure 8.15

D-POWER 2 (Measurements of a typical performance)

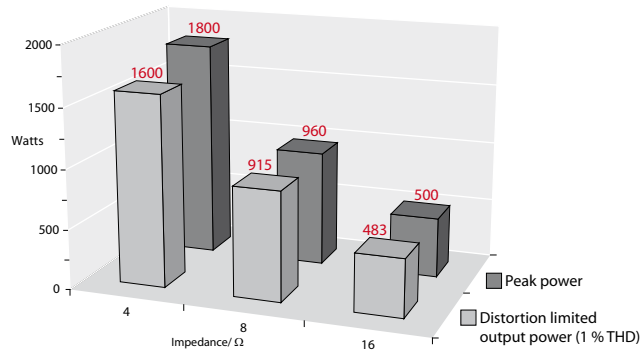

Figure 8.14

D-POWER 3 (Measurements of a typical performance)



8.1 Summary of Warranty

CAMCO guarantees the **D-POWER** Amplifier to be free from defective material and/or workmanship for a period of six (6) years from the date of sale. When a defect occurs under normal installation and use, **CAMCO** will repair the product under this warranty. In this event, please return the amplifier to your dealer/distributor together with a copy of your sales receipt as proof of purchase.

This warranty provides that examination of the returned product must indicate in our judgment a manufacturing defect.

8.2 Items Excluded from This Warranty

CAMCO is not liable for any damage caused by shipping accidents, misuse, abuse, operation with incorrect AC voltage, operation with faulty peripheral equipment, modification or alteration without prior factory approval, service by an unauthorised service center and normal wear and tear. Amplifiers on which the serial number has been removed or defaced are not eligible for warranty service.

8.3 What CAMCO Will Do

CAMCO (or its appointed agent) undertakes to rectify any defect regardless of the reason for failure (unless excluded from this warranty), by repair, replacement or refund as it sees fit.

8.4 How to Obtain Warranty Service

You must notify your dealer/distributor of your need for warranty service. All components must be shipped in the original packaging.

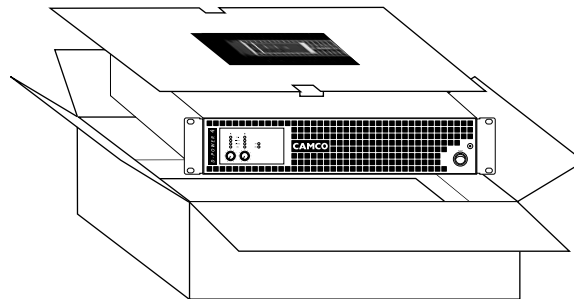

8.5 CAMCO Product Improvement

CAMCO reserves the right to improve the technical standard of its products without giving prior notice. If in any doubt, please consult your dealer/distributor or contact **CAMCO** directly for clarification.



**PLEASE ENCLOSE THIS COMPLETED FORM WITH THE AMPLIFIER
DO NOT SEND SEPARATELY**

Owner's Information

Company Name: _____

Contact: _____

Address: _____

Telephone: _____

Facsimile: _____

eMail Address: _____

Model: _____

Serial Number: _____

Purchase Date: _____

Expired Warranty

If the warranty has expired, payment will be:

Cash/Cheque

VISA

MasterCard

Shipping Address

To transport the amplifier, the original packing materials must be used. Please return the amplifier to the following address or your nearest **CAMCO** appointed distributor.

Nature Of Problem

Please describe the conditions that existed when the problem occurred and what attempts were made to correct it: _____

Other equipment in your system: _____

CAMCO Produktions- und Vertriebs-GmbH für Beschallungs- und Beleuchtungsanlagen, Fischpicke 5, D-57482 Wenden, Germany





10 Maintenance Information

Cleaning and servicing the inside of the amplifier must never carry out by unqualified personnel. The amplifier must never be opened by unqualified personnel.

Cleaning and servicing work on the inside of the amplifier must only be carried out by qualified personnel.

Qualified personnel is defined as a person who has gained specialised relevant knowledge of electronic engineering through education, training and experience and who has sufficient knowledge of all relevant governmental work safety regulations to be in a position to judge the safe functioning of power amplifiers based on technical rules according to IEC 60065.

(IEC 60065 (DIN EN 60065) "Safety Requirements for Audio, Video or similar Electronic Appliances")

In order to guarantee the safe functioning of the amplifier, it has to be checked regularly depending on its application but at least once a year by a properly qualified person.

Advice on how to carry out these checks can be found in DIN VDE 0702-1 "Safety Checks for Electronic Appliances".

An amplifier that is considered to be unsafe must be labelled accordingly and stored in a safe place to prevent this amplifier being used mistakenly.

For details on removal and cleaning of the front filter refer to section 4.7.

11 Decommissioning

During the decommissioning process of the amplifier, all legally prescribed rules and procedures must be adhered to.



Mailing Address:

CAMCO Produktions- und Vertriebs-GmbH
für Beschallungs- und Beleuchtungsanlagen
Fischpicke 5
D-57482 Wenden
Germany

Telephone:

+49 (0) 2762 408-0

Facsimile:

+49 (0) 2762 408-10

Internet:

www.camcoaudio.com

Email:

postmaster@camcoaudio.com



NOTICES

CAMCO

www.camcoaudio.com